

Laboratory Protection Clean Air Solutions



● Headquarter ● Global warehouse ● Training center ● Global subsidiary ● Manufacturing base



CONTENT

• Quality Control -----	02
Certification -----	02
QC - Tests and Inspections -----	02
Patented Technologies -----	02
• Pharmacy Intravenous Admixture Services -----	03
• Biological Safety Cabinets and Clean Bench Differences -----	04
• Selection Guide for Biological Safety Cabinets -----	04
• Haier Biomedical Safety Cabinet, Type A2 -----	05
NSF Series -----	05
Smart IoT Series -----	07
Intelligent Series -----	11
Classic Series -----	21
• Haier Biomedical Safety Cabinet, Type B2 -----	27
Classic Series Type B -----	27
• Haier Biomedical Clean Bench/Laminar Flow -----	31
• Standard Operational Procedures for Safety Cabinets -----	37
• Summary of Specifications -----	40

Certifications, Quality Control, Patented Technologies >>



• Certifications

- Safety certification to EN 61010
- EMC certification EN 61326
- Certified EU EN 12469 for Biological Safety Cabinets
- Certified Chinese medical device registration YY-0569
- ISO 13485:2016 and ISO 9001:2015 Certified Company

Strict QC Tests and Pre-delivery Inspections >>

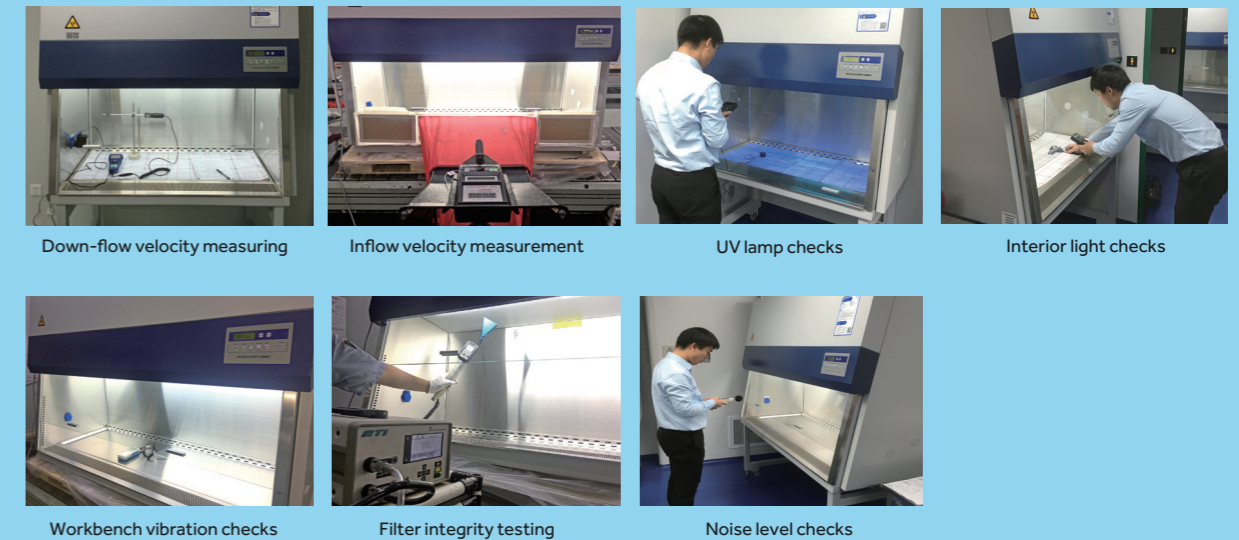

Down-flow velocity measuring Inflow velocity measurement UV lamp checks Interior light checks

Workbench vibration checks Filter integrity testing Noise level checks

• Patented Technologies



LNS energy-saving mode (the fan will stop automatically once people leave for 15 minutes) Intelligent constant air velocity Pressure sensors monitoring service life of filters UV lamp one-touch protocol Prevent airflow from overflowing

Safe Admixture Solution for Medicine

Typical Application for PIVAS (Pharmacy Intravenous Admixture Service)

Haier Biomedical clean bench ensures a superior cleanliness environment while the technical specialists /medical staff perform the admixture of intravenous fluid for PIVAS.



Introduction to Safe System Solution for PIVAS

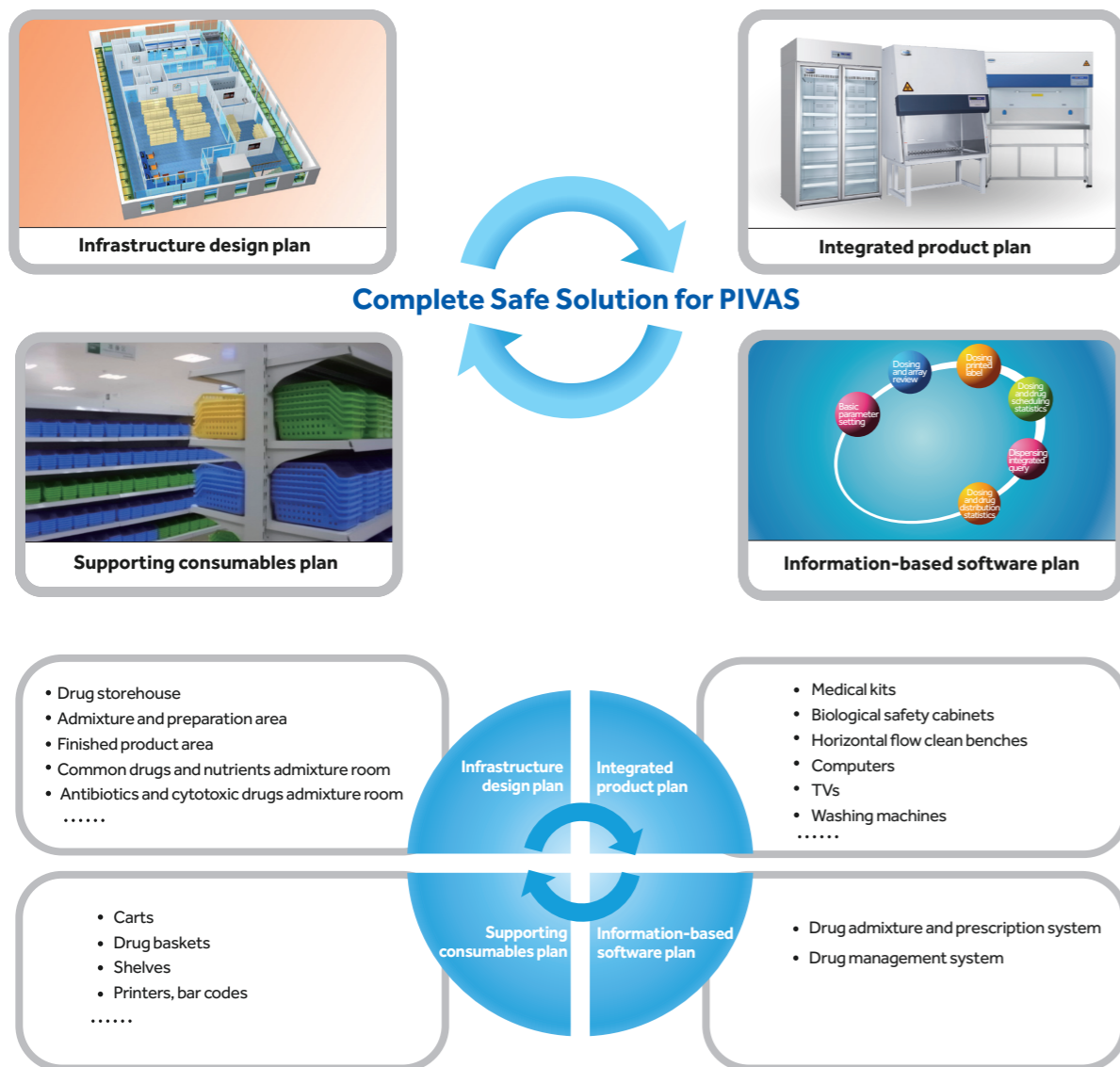

Differences between Biological Safety Cabinet and Clean Bench

Working Principles

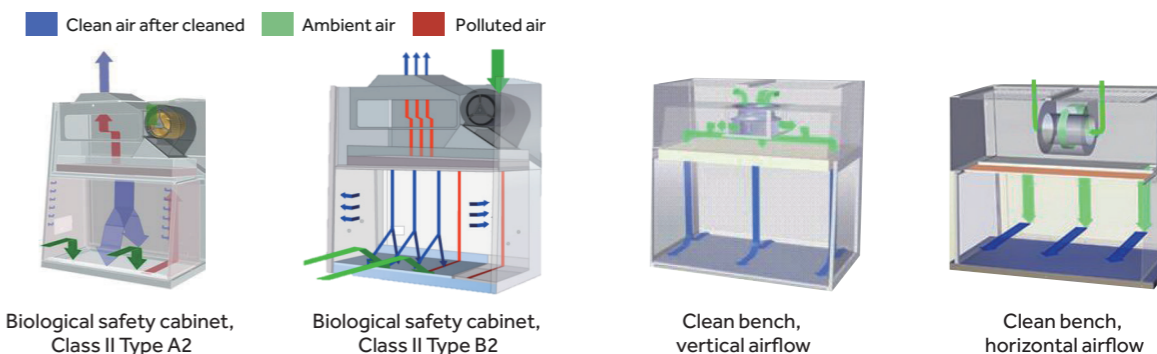

Functions

Product category	Airflow circulation	Applications	Air supply mode	Filter	Operator protection	Sample protection	Environment protection
Biological safety cabinet, Class II, Type A2	70% circulated, 30% discharged	Operation of pathogenic bacteria, mold, yeast and other hazardous samples	Negative pressure (Air pulled into cabinet)	High efficiency	✓	✓	✓
Biological safety cabinet, Class II, Type B2	100% discharged to outdoor space						
Vertical flow clean bench	100% discharged to indoor space	Operation of non-hazardous bacteria, PIVAS	Positive pressure (Supply air to space outside of cabinet)	High efficiency	✗	✓	✗
Horizontal flow clean bench	100% discharged to indoor space						

Model Selection Guide for Biological Safety Cabinet

	Applications	Class II, Type A2	Class II, Type A2 + Discharge Ducting	Class II, Type B2
Biotechnology	Sterilized culture medium preparation	✓	✓	✓
	Non-biohazard culture medium preparation	✓	✓	✓
	Culture	✓	✓	✓
	Non-biohazard tissue culture	✓	✓	✓
	Tissue culture	✓	✓	✓
	Plant tissue culture	✓	✓	✓
	Blood composition analysis	✓	✓	✓
	Human tissue research	✓	✓	✓
Microorganism	PCR	✓	✓	✓
	Sterilized culture medium preparation	✓	✓	✓
	Non-biohazard culture medium preparation	✓	✓	✓
	Culture	✓	✓	✓
	Odorous substance culture	✓	✓	✓
	Non-biohazard culture	✓	✓	✓
	Isolated clinical specimen	✓	✓	✓
	Blood analysis	✓	✓	✓
	QA/QC	✓	✓	✓
	Non-volatile toxic substance staining	✓	✓	✓
Medicine	Trace-volatile toxic substance staining	✓	✓	✓
	Non-volatile substance radioisotope labelling	✓	✓	✓
	Trace-volatile substance radioisotope labelling	✓	✓	✓
	Anticancer drug preparation	✓	✓	✓
Routine research	Trace-volatile substance preparation	✓	✓	✓
	Cell/tissue fixation/staining	✓	✓	✓
	Toxic powder/suspended solids	✓	✓	✓

Microbiological Safety Cabinet Applications

Class II microbiological safety cabinets protect the operator, sample and environment from harmful exposure to biohazards and can be used within a broad range of laboratory settings including hospitals, life science research, pharmaceutical, cosmetics and related industries.

Suitable for cell, microorganism and animal related applications, for example stem cell research, blood disease, regenerative medicine research, clinical pathology, sterile pharmacy compounding, sewage treatment and soil analysis.

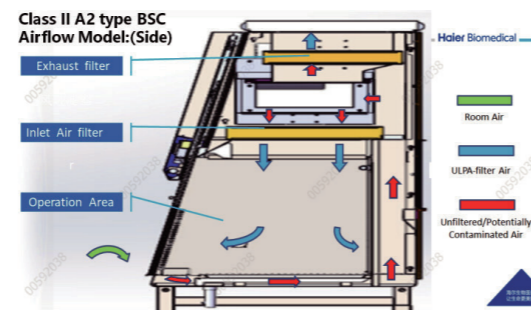

The biosafety cabinet is a negative pressure filtration and exhaust cabinet used to prevent the operator from being exposed to the bio-aerosol generated during the experiment, ultimately to ensure the protection for the operators, the samples and the environment.

Biological Safety Cabinet: NSF Series

Product Advantages

Microprocessor Control System

- Intuitive and informative interactive digital LCD display.
- The hot-ball anemometer monitors the downflow and inflow wind speed of the safety cabinet in real time and compares it with the standard wind speed. The rotating speed of the fan is adjusted through the microprocessor system to maintain the constant wind speed of the safety cabinet
- Real-time display of operational information and parameters including downflow air velocity, flow rate, temperature, humidity, positive pressure, negative pressure, fan cumulative running time and filter remaining service life
- One button UV lamp timer function, allows users to set 0 to 24 hours of automatic on/off time

Superior Filter, Multiple Protection

- ULPA is made of moisture-proof and flame-retardant glass fiber filter paper which can intercept 99.9995% solid particles with a diameter of 0.12 μm to ensure high cleanliness of air supply flow and exhaust flow
- Perfect air distribution design, no turbulence in the working area
- Sound and light alarm function for abnormal parameters

Multiple Voltage Options, Suitable for Many Countries and Regions

- Full voltage coverage (100-230V 50/60Hz), suitable for a wide range of countries and regions

One-piece Welded Cabinet Structure, Leak Proof

- Prevention of leakage performance of dangerous factors conforms to NSF specification

Ultra-Low Noise, Uniform Airflow

- Designed with Dual DC centrifugal fans, combined with an innovative air distribution system, with lower noise, and more uniform air flow

Specifications

Model	Working Voltage&Frequency (V/Hz)	Downflow Velocity(m/s)	Inflow Velocity(m/s)	Fluorescent Lamp Intensity(Lux)	Net/Gross Weight(approx)	Interior Dimension (W*D*H)	Exterior Dimension (W*D*H)	External Dimensions Without Arm Rest (W*D*H)	Packing Dimension (W*D*H)	Container load (20/40/40'H)	Support Stand	Certification
HR1200-IIA2-N	100-230/50/60	0.35	0.53	1323	275/335 (kg) 617/750 (lbs)	1230*600*650 (mm) 48.4*23.6*25.6 (in)	1340*850*2160 (mm) 52.8*33.5*85 (in)	1340*790*2160 (mm) 52.8*31.1*85 (in)	1400*900*1710 (mm) 55.1*35.4*67.3 (in)	8/16/16	680	UL, NSF
HR1800-IIA2-N	100-230/50/60	0.35	0.53	1292	375/460 (kg) 827/1014 (lbs)	1830*600*650 (mm) 72.0*23.6*25.6 (in)	1940*850*2160 (mm) 76.4*33.5*85 (in)	1940*790*2160 (mm) 76.4*31.1*85 (in)	2000*900*1710 (mm) 78.7*35.4*67.3 (in)	6/12/12	680	UL, NSF

Adjustable Stands (Optional): 680-900mm adjustable height

Product Features

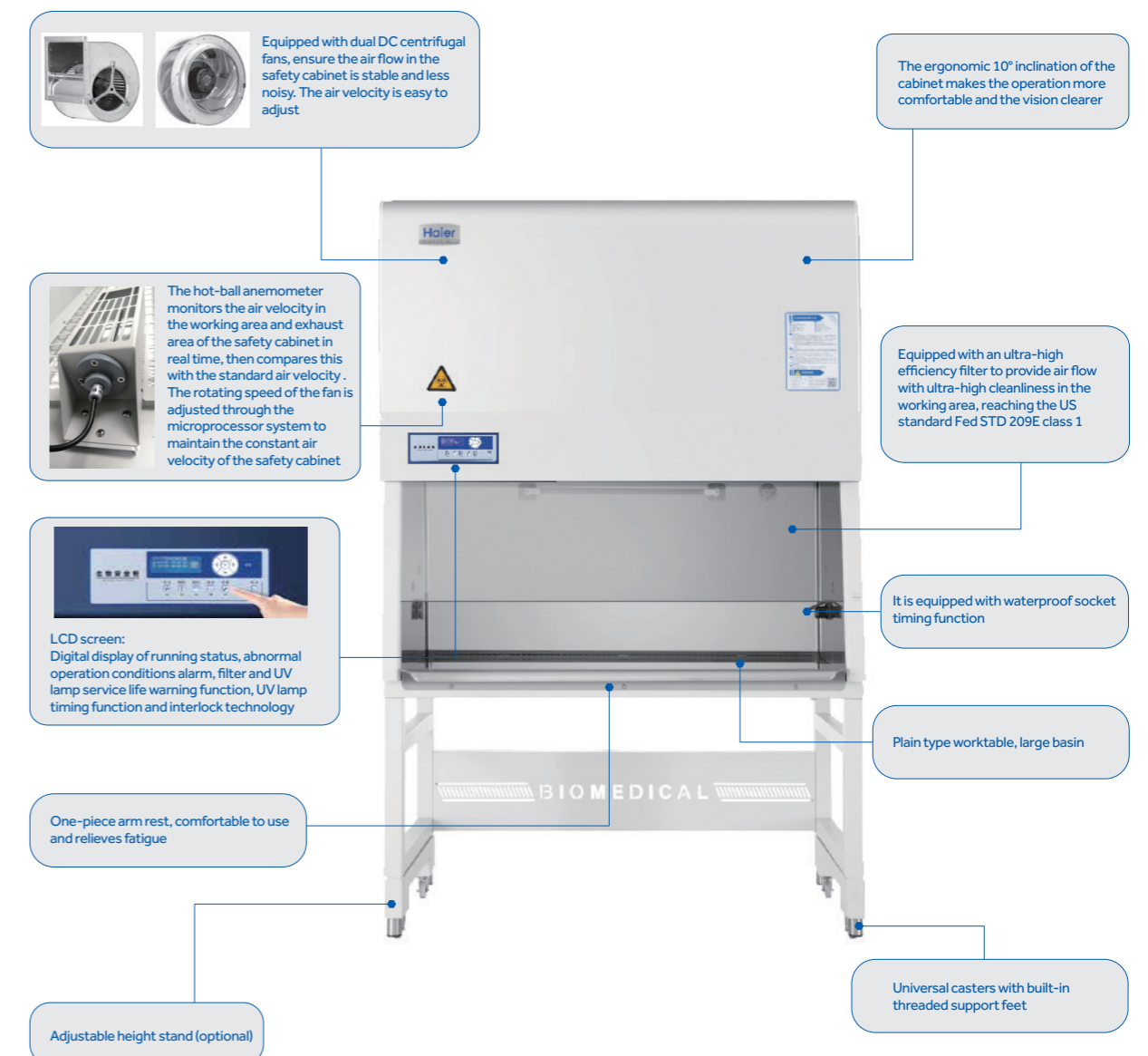

Biological Safety Cabinet: Smart IoT Series

Haier Biomedical's Smart IoT series of Class II microbiological safety cabinets provide life science, pharmaceutical, medical and healthcare professionals with 3 layers of protection – personnel, product and environment.

• Dual DC Fans

Two high quality DC fans are adopted to ensure high reliability while lowering noise output and conserving energy, giving a 50% energy saving compared to the traditional AC fans. The fans can supply air at a constant velocity by eliminating the effects of voltage fluctuation on the RPM. Each of them can independently regulate the air supply volume and air exhaust volume, to ensure the optimal matching between the air flows.



• Optional Electric Sash

An electric lifting glass sash is available which is operated by a foot switch. The screen can be opened or closed easily, improving the work efficiency.



• Dual Cameras

As an option, two surveillance cameras can monitor and record the conditions at each side of the working area. The camera is positioned to avoid any splashback within the working area, minimizing cleaning required.



• Intelligent IoT module

An IoT module is an option available to enable users to simply manage the biosafety cabinets, any time anywhere, using our app. The system monitors the cabinet in real-time and alerts in the event of any abnormal alarms. Users can view operational parameters, operation performance curves, event and alarm records as well as other useful information.

Ergonomic Design

• 10° Inclination

The 10° angle design of the front interface is more ergonomic, ensuring more comfortable operation.

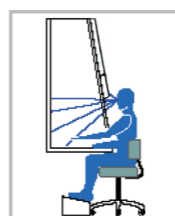

• Stainless Steel Arm Rest

Designed for comfort, the arm rest helps to reduce fatigue and the leakproof structure ensures spillages do not seep into armrest.



• Dropdown Front Sash Window

Remove the armrest and drop down the front window to clean the upper edge of glass conveniently, without leaving any blind spots.



• One-piece Workbench

A platform-type workbench is equipped with two stainless steel foldable lifting handles. Large collecting basin protects entire work area from leakage.



• One-Touch UV Lamp Operation

UV lamp records and remembers users' setting and habits and can be preset with a startup delay with one-key operation for ease and convenience.

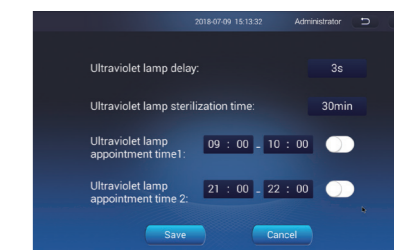

• IP 44 Rated Power Sockets with Timer

The sockets can be programmed to supply power at a specified time to meet the users' demands for timing of experiments.

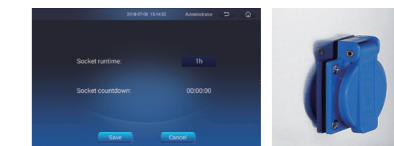

• Universal Casters with Built-in Threaded Supporting Legs

The stand is designed with universal casters for manoeuvrability and built-in threaded supporting legs help prevent contamination.



Biological Safety Cabinet: Smart IoT Series

Product Configuration

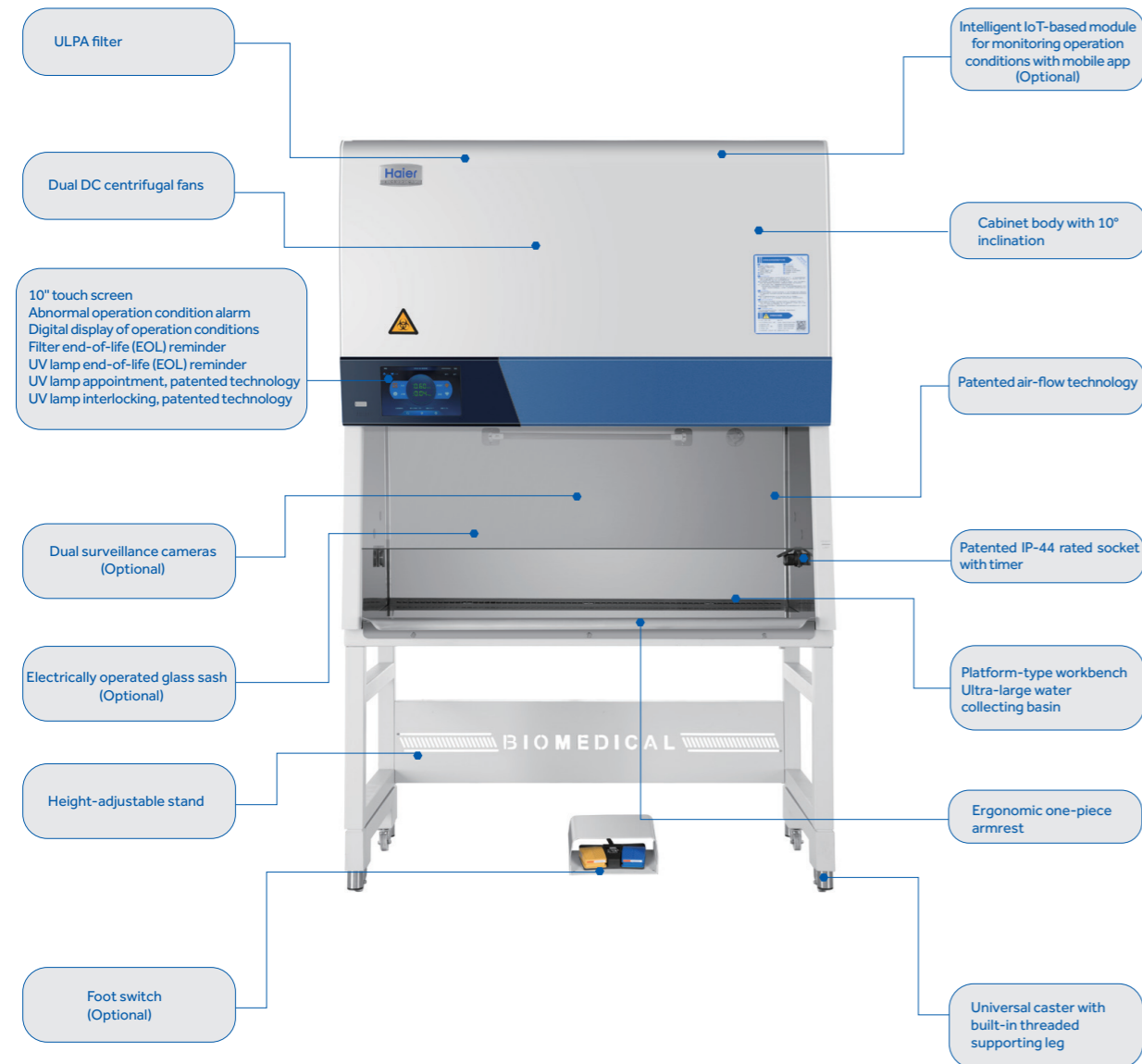

Specifications

Model	External Dimensions Without Arm Rest (W*D*H)	Downflow Velocity(m/s)	Inflow Velocity(m/s)	Fluorescent Lamp Intensity(Lux)	Net/Gross Weight(approx)	Interior Dimension (W*D*H)	Exterior Dimension (W*D*H)	External Dimensions Without Arm Rest (W*D*H)	Packing Dimension (W*D*H)	Container load (20/40/40H)	Support Stand	Certification
HR1200-IIA2-X	220/50/60	0.3	0.45	1317	280/340(kg)	1230*600*655(mm)	1336*845*2120(mm)	1336*790*2120(mm)	1400*925*1665(mm)	8/16/16	680-900mm adjustable	NMPA(CFDA), CE,TUV SUD Mark
					617.3/749.6(lbs)	48.4*23.6*25.8(in)	52.6*33.3*83.5(in)	52.6*31.1*83.5(in)	55.1*36.4*65.6(in)			
HR1500-IIA2-X	220/50/60	0.3	0.45	1396	320/400(kg)	1530*600*655(mm)	1636*845*2120(mm)	1636*790*2120(mm)	1700*925*1665(mm)	6/12/12	680-900mm adjustable	NMPA(CFDA), CE,TUV SUD Mark
					705.5/881.8(lbs)	60.2*23.6*25.8(in)	64.4*33.3*83.5(in)	64.4*31.1*83.5(in)	66.9*36.4*65.6(in)			
HR1800-IIA2-X	220/50/60	0.3	0.45	1133	380/465(kg)	1830*600*655(mm)	1936*845*2120(mm)	1936*790*2120(mm)	2000*925*1665(mm)	6/12/12	680-900mm adjustable	NMPA(CFDA), CE,TUV SUD Mark
					837.8/1025.1(lbs)	72.0*23.6*25.8(in)	76.2*33.3*83.5(in)	76.2*31.1*83.5(in)	78.7*36.4*65.6(in)			

Optional components

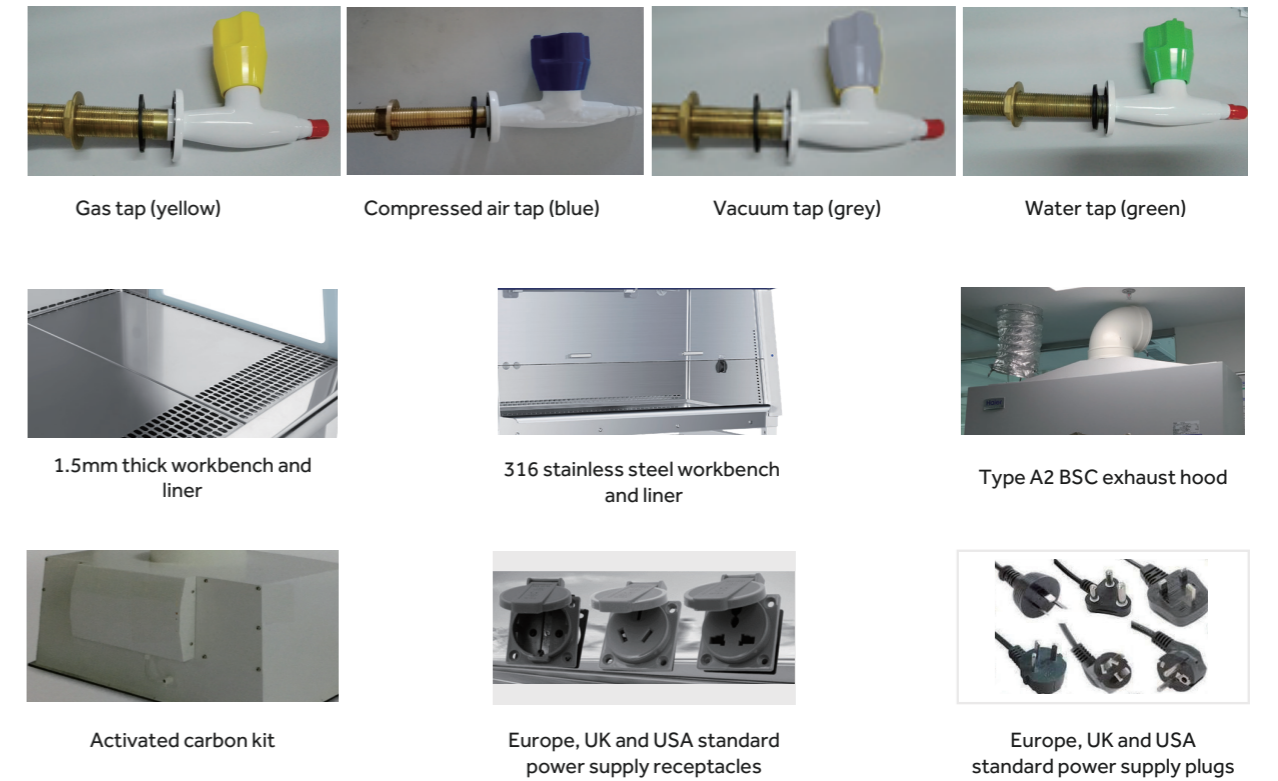

Biological Safety Cabinet: Intelligent Series

Intelligent

- **Constant airflow velocity**

The hot-bulb airflow velocity transducer performs real-time monitoring of the air velocity of the working area, compares it with the standard air velocity, and keeps a constant air velocity in the cabinet by regulating the fan speed with a microcomputer system.

Energy Conservation

- **Human body sensing and energy conservation**

Under the intelligent mode, when the human body sensor module detects no operator in the operation area for 15 minutes, the microcomputer will automatically switch the safety cabinet into the LNS energy saving green mode to reduce the noise level, save energy and prolong the service life of filter.



Ergonomic

- **10° inclination design of cabinet body**

The front operation interface has an ergonomic design of 10° inclination for ensuring more comfortable operation.

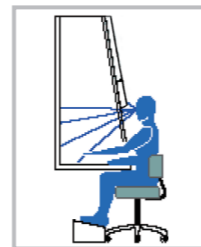

- **Stainless steel arm rest**

A comfortable platform-type armrest can reduce hand and arm fatigue.



- **Drop-down front window**

Remove the armrest and drop down the front window to clean the upper edge of glass conveniently, without leaving any blind spots.



- **V-shaped air inlet**

The V-shaped air inlet can prevent the samples or arms of operator from blocking the air flow. The work surface can be easily lifted using the handles for cleaning purposes.



- **One-Touch UV Lamp Operation**

UV lamp records and remembers users' setting and habits and can be preset with a startup delay with one-key operation for ease and convenience.



- **IP 44 Rated Power Sockets with Timer**

The sockets can be programmed to supply power at a specified time to meet the users' demands for timing of experiments.



- **Universal Casters with Built-in Threaded Supporting Legs**

The stand is designed with universal casters for manoeuvrability and built-in threaded supporting legs help prevent contamination.



Key Components

• Ultra-Low Particulate Air (ULPA) Filter (U15)

- The ULPA filter made of moisture-proof and fireproof glass fibers has efficiency up to 99.9995% when filtering 0.12 μ m solid particles, fully meeting the cleanliness requirements of USA FED STD 209E Grade 1 (or ISO 14644-1 Grade 3).
- ULPA filter ensures vertical air flow to the workbench, preventing the samples from being contaminated.
- The filter can be scanned point by point to ensure high performance, reliability and safety.

• Maintenance-free fan system

- Forward centrifugal fan with air inflows at both sides of motor, reduces noise to a very low level
- The fan self-cools to ensure high reliability and low energy consumption
- Optimal balance between air supply and energy consumption
- Stable air flow for safety cabinet upon precise control of fan operation

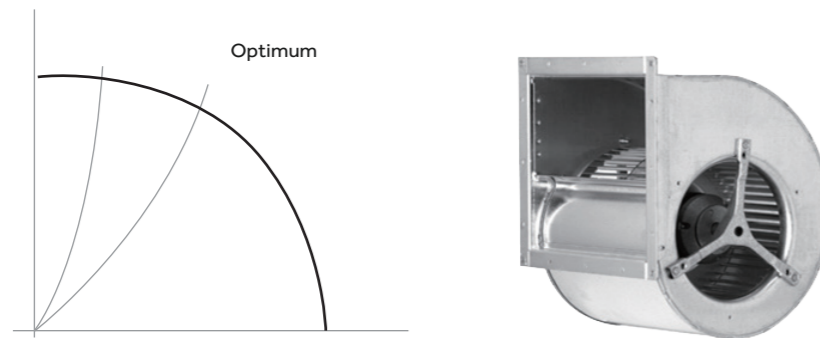

Safe

• Abnormal operation condition alarm

Audible and visual alarms in form of voice or text will be present when air turbulence level exceeds 20% and door height (high or low) or work area temperature exceeds limits.

• Patented technology: filter end-of-life reminder

Pressure transducer monitors the resistance variation of filter to determine the remaining life of filter and will remind the user by warning when the remaining life is below 10%.

• Patented technology: UV lamp end-of-life reminder

The microcomputer will add up the service time of UV lamp, and will remind by warning the user to replace the UV lamp when its remaining life is less than 10%.

• Interlocking feature to ensure maximum safety and reliability

- Patented technology: UV lamp interlocking control
UV lamp, front window, fan and interior light operation are interlocked together to protect against harmful UV rays and to prevent leakage of microorganisms.
- For Type A2 safety cabinet with internal & external fans interlocked, the external fan will be activated first when the safety cabinet is powered on and the internal fan will be deactivated first when the safety cabinet is powered off. When the air inflow is lower than the limit, the internal fan will be deactivated and the external fan will continue working, while users are alerted by the audible and visual alarms. When the internal fan is deactivated during working, the external fan will continue working, accompanied with audible and visual alarms.

Professional

• Digital display of operating parameters

Real-time digital display of down flow, inflow, exhaust volume, working area temperature, filter remaining life, UV lamp remaining life, negative pressure and positive pressure.

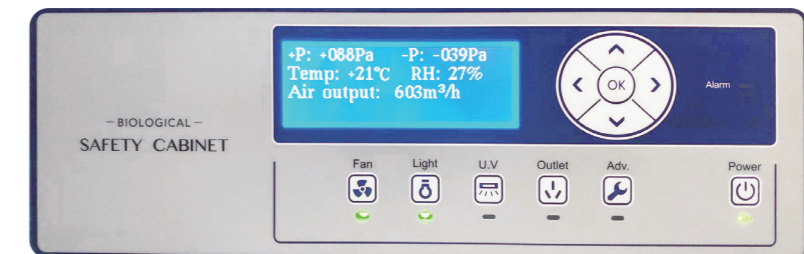

• Key component failure alarm

Audible and visual alarms will be given in case of any failures in the airflow velocity sensor, pressure sensor, temperature sensor, microcomputer board or air flow valve, indicating the nature of failure in voice or text.

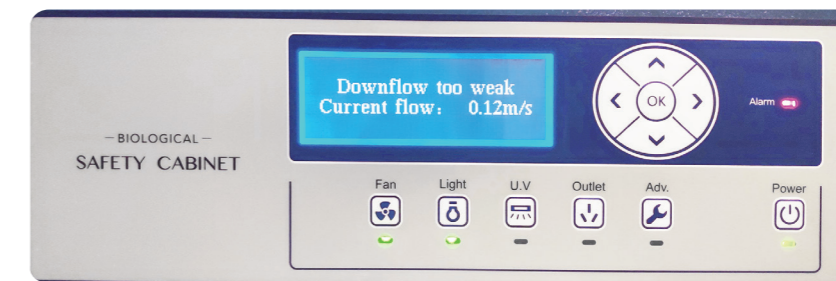

Biological Safety Cabinet: Intelligent Series

Mini Biological Safety Cabinet HR700-IIA2 with Single Exhaust Filter

Product Advantages

Small size microbiological safety cabinet for single person operations and small working spaces, suitable for testing stations within warehouse, airports and mobile laboratories.

Safe and Reliable

Adopts AAF filters, class 1 cleanliness to provide maximum protection for people, environment and samples

LCD Display

LCD screen displays various parameters and service life of accessories in real time, and the operational condition of the equipment is clear at a glance

One-click Operation

UV lamp one-click reservation allows users to set 0 min to 24 hours of automatic on/off time and sterilization interval, reducing the waiting time

Two Waterproof Sockets

Sockets include timing technology to allow users to program socket on/off times

Interlocking Function

The product features an interlocking function between UV disinfection, fluorescent lamp, front window and fan

Alarms

Audible and visual alarm functions: hardware failure alarm, operation parameter overrun alarm, filter and UV lamp life warning

Uniform Airflow

The EBM fan, combined with Haier's professional air distribution design, provides lower noise operation and a uniform air flow

Safety Certified

Designed according to E.U. EN12469

Innovative Design

- Space-saving design with large working area
- Ergonomic design for single person
- Real-time monitoring of the airflow for safety
- Energy-efficient EBM motor

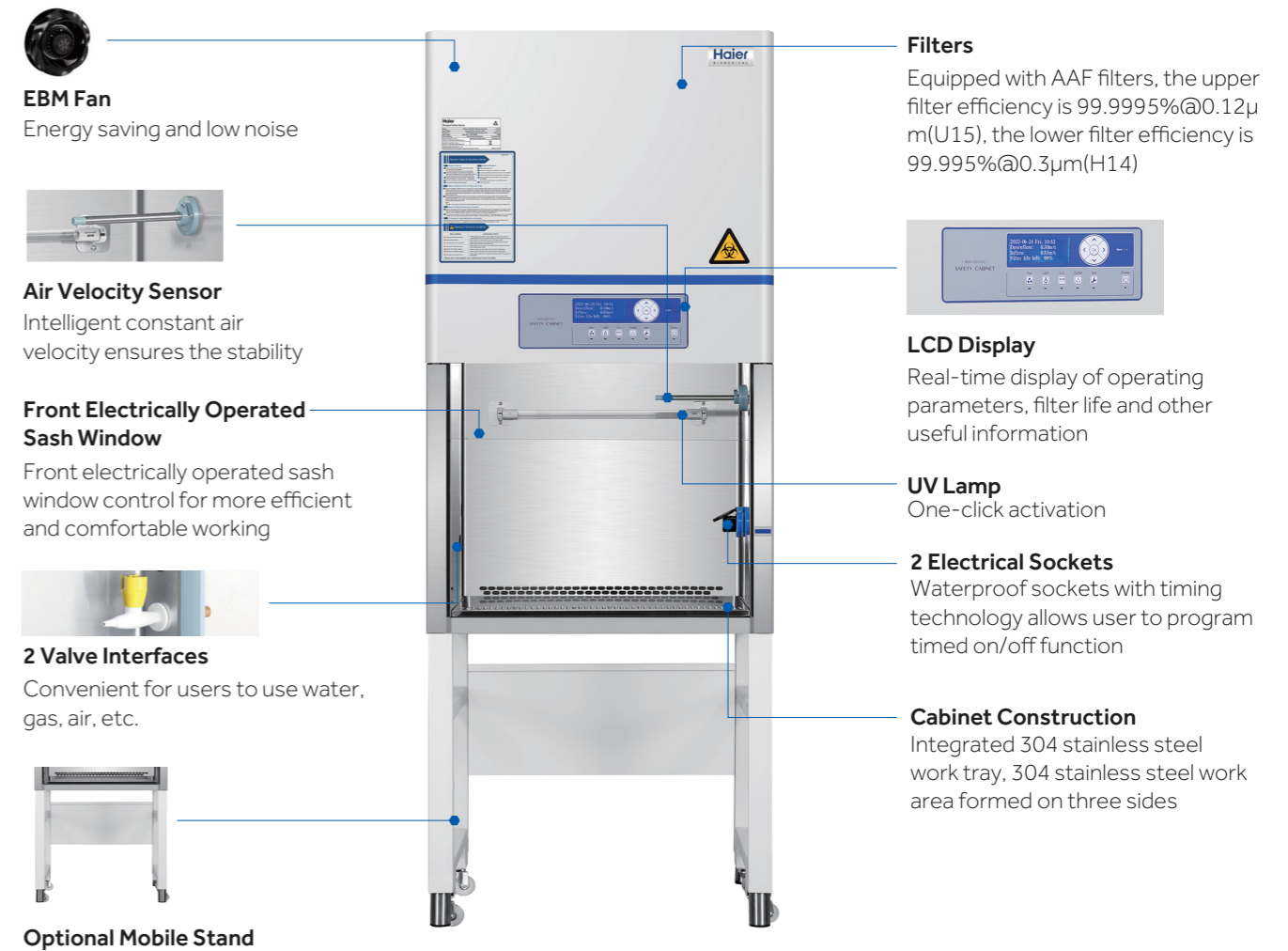

Biological Safety Cabinet: Intelligent Series with Single Exhaust Filter

Product Configuration

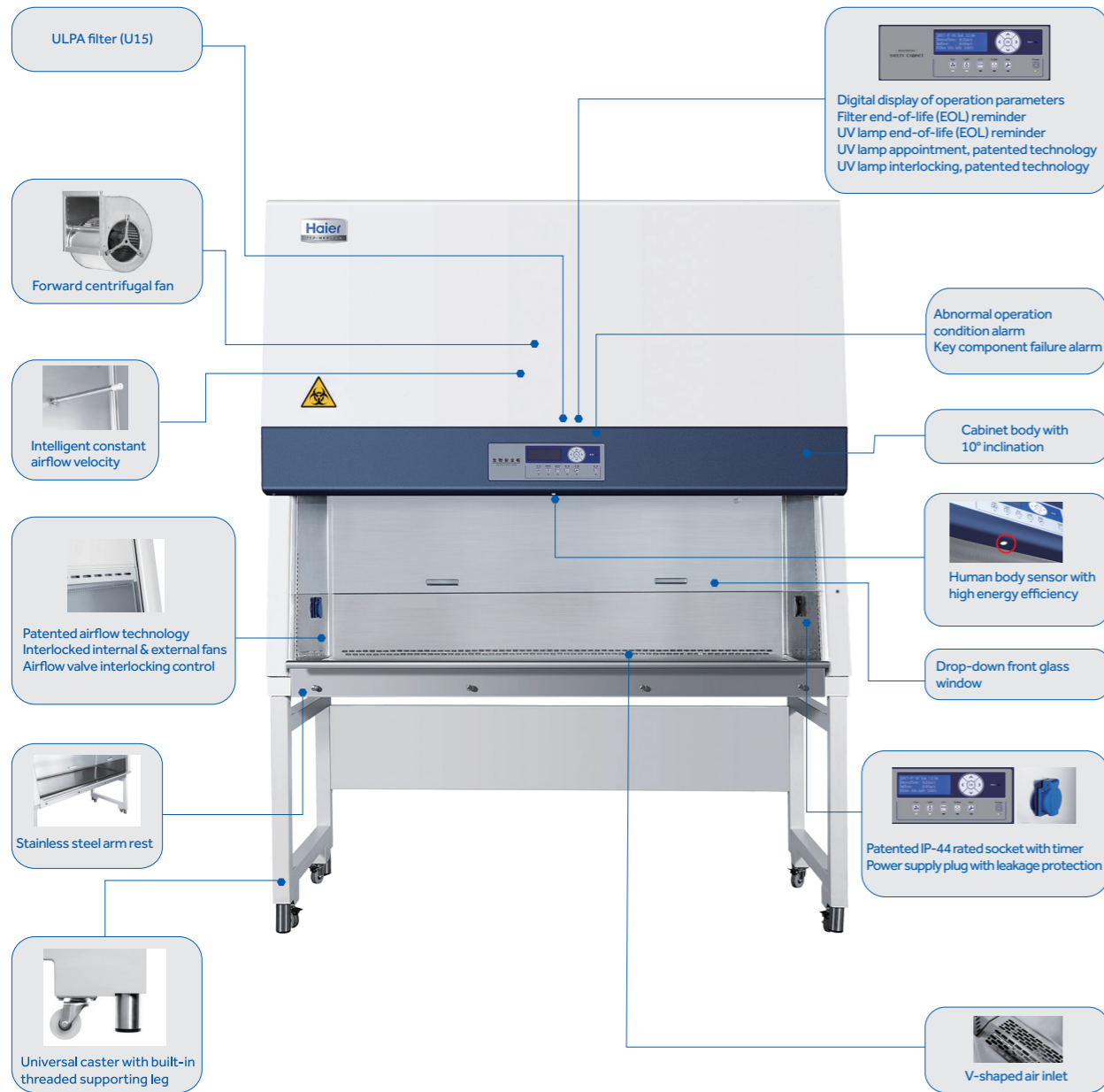

Specifications

Model	Working Voltage&Frequency (V/Hz)	Downflow Velocity (m/s)	Inflow Velocity (m/s)	Fluorescent Lamp Intensity(Lux)	Net/Gross Weight (approx)	Interior Dimension (W*D*H)	Exterior Dimension (W*D*H)	External Dimensions Without Arm Rest (W*D*H)	Packing Dimension (W*D*H)	Container load (20'/40'/40'H)	Support Stand	Certification
HR700-IIA2	220/50/60	0.30	0.53	≥700	100/130 (kg)	600*550*540 (mm)	700*720*1200 (mm)	700*720*1200 (mm)	795*790*1370 (mm)	14/28/28	700(optional)	NMPA(CFDA), CE, TUV SUD Mark
					220.4/286.52 (lbs)	23.62*21.65*21.26 (in)	27.56*30.91*50.93 (in)	27.56*30.91*50.93 (in)	31.3*31.1*53.93 (in)			
HR900-IIA2	220/50	0.33	0.55	≥900	290/310 (kg)	920*620*650 (mm)	1080*845*2160 (mm)	1080*790*2160 (mm)	1145*920*1690 (mm)	12/24/24	680-900mm adjustable height	NMPA(CFDA), CE, TUV SUD Mark
					639.3/683.4 (lbs)	36.2*24.4*25.6 (in)	42.5*33.3*85.0 (in)	42.5*31.1*85.0 (in)	45.1*36.2*66.5 (in)			
HR1200-IIA2	220/50	0.34	0.55	≥900	320/339 (kg)	1220*620*650 (mm)	1380*845*2160 (mm)	1380*790*2160 (mm)	1470*920*1690 (mm)	8/16/16	680-900mm adjustable height	NMPA(CFDA), CE, TUV SUD Mark
					705.5/747 (lbs)	48.0*24.4*25.6 (in)	54.3*33.3*85.0 (in)	54.3*31.1*85.0 (in)	57.9*36.2*66.5 (in)			
HR1500-IIA2	220/50	0.31	0.55	≥900	350/393 (kg)	1520*620*650 (mm)	1680*845*2160 (mm)	1680*790*2160 (mm)	1755*920*1690 (mm)	6/12/12	680-900mm adjustable height	NMPA(CFDA), CE, TUV SUD Mark
					771.6/866.4 (lbs)	59.9*24.4*25.6 (in)	66.1*33.3*85.0 (in)	66.1*31.1*85.0 (in)	69.1*36.2*66.5 (in)			

Optional components

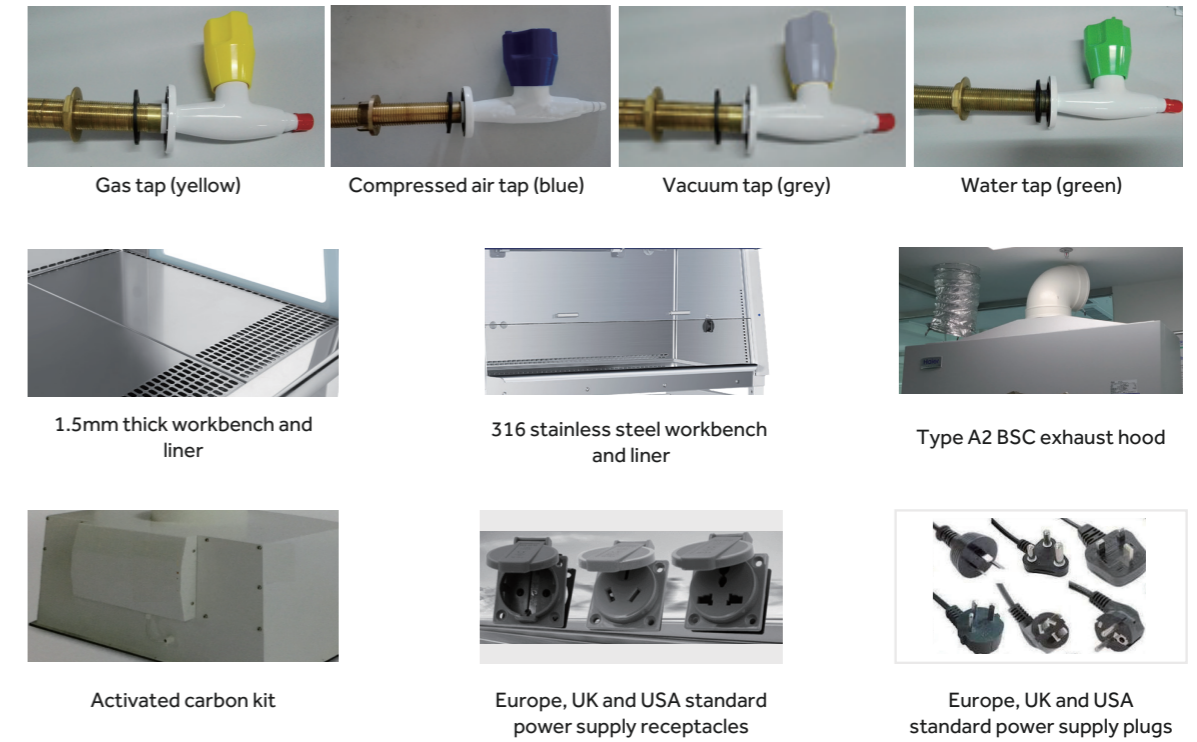

Biological Safety Cabinet: Intelligent Series with Dual Exhaust Filter & Dual Fans- HR1200-IIA2-D

Product Advantages

Developed for requirements for dual exhaust filtered biosafety cabinets and manufactured to BS EN12469. The model HR1200-IIA2-D is a smart, energy-efficient and high-performance biosafety cabinet offering 3-levels of protection – personnel, samples and environment.

- Adopts energy-efficient and low-noise fans
- ULPA filters
- 10° design and glass-sided structure provides more comfortable working and improves light to reduce eye stress and fatigue.
- Adjustable stand, UV and electrical sockets are included as standard



Features

- The main filter uses damp-proof, fire-proof glass fiber ULPA filter. Filtering efficiency for $\geq 0.12\mu\text{m}$ particulate matter is $\geq 99.9995\%$ for cleaner air and safer samples.
- DC fan operates with lower noise and better air flow uniformity.
- LCD screen displays various parameters and clear operational conditions.
- UV lamp can be set with one single key to activate/deactivate automatically at specified sterilization intervals from 0min to 24h, to minimize the waiting time.
- The product features a system for interlocking the ultraviolet sterilization, fluorescent lamp, front window and fan motor with each other.
- Multiple audible and visual alarms: hardware malfunction alarm, operating parameter overrun alarm, filter/UV lamp lifecycle ending alarm, etc.
- Patented water-proof receptacle timer: two water-proof receptacles can be automatically powered on/off by the timer.

Ergonomic Design

- 10° angled front design provides a comfortable work space for operators.
- Adjustable stand (680-900mm) with recessed mechanism to reduce risk of contamination.
- Universal caster for convenient moving.
- Drop-down front window design for easier cleaning of the upper edge of glass.
- Removable armrest reduces fatigue and does not interfere with air inflow.
- Optional accessories include water valves, air valves, electronic sash window and electric adjustable stand

Structure and Dimensions

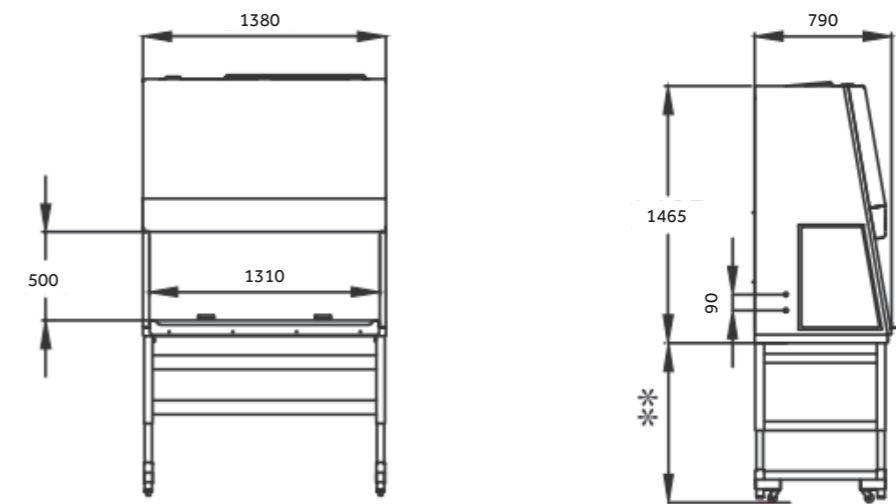

*Stand with height adjustable within 680-900mm

Specifications

Model	Working Voltage&Frequency (V/Hz)	Main Filter Typical Efficiency	Downflow Velocity (m/s)	Inflow Velocity (m/s)	Fluorescent Lamp Intensity (Lux)	Internal Dimension (W*D*H)	External Dimension (W*D*H)	External Dimension Without Arm Rest (W*D*H)	Packing Dimension (W*D*H)	Support Stand (optional)	Certification
HR1200-IIA2-D	220/50/60	ULPA U15.99.9995% @0.12µm	0.30	0.45	≥ 1000	1310*620*630 (mm) 51.6*24.4*24.8 (in)	1380*850*2160 (mm) 54.3*33.5*85.0 (in)	1380*790*2160 (mm) 54.3*31.1*85.0 (in)	1470*920*1690 (mm) 57.9*36.2*66.5 (in)	680-900 (mm) adjustable height	CE, TUV SUD Mark, NMPA (CFDA)
HR900-IIA2-D	220-240/50/60	ULPA U15.99.9995% @0.12µm	0.30 (60)	0.55	≥ 1300	936*620*635 (mm) 36.9*24.4*25.0 (in)	1002*796 (856)*1485 (mm) 39.5*31.3 (33.7)*58.5 (in)	/	1070*895*1680 (mm) 42.1*35.2*66.1 (in)	680-900 (mm) (26.8-35.4") adjustable height	CE, UKCA

Biological Safety Cabinet: Intelligent Series with Single Exhaust Filter & Dual Fans-HR1200-IIA2-S

Product Advantages

Developed and manufactured to meet BS EN12469. The model HR1200-IIA2-S is an energy-efficient and high-performance biosafety cabinet offering 3-levels of protection – personnel, samples and environment.

- Adopts energy-efficient and low-noise fans
- HEPA filter
- 10° design and glass-sided structure provides more comfortable working and improves light to reduce eye stress and fatigue.
- Additional standard features include – adjustable stand, UV and waterproof electrical sockets

HR1200-IIA2-S

EBM DC fan, energy consumption as low as 112W, low noise to 58dB.

AAF filter 99.995% @ 0.3µm

Standard water-proof socket, water valve and air valve interface.

Dual wind speed sensors

Electrical glass door motor make the use procedure more comfortable. (Optional)

With the third generation computer board, the program is more intelligent and the air flow self-regulation is more sensitive.

Optional parts: adjustable stand and electric underframe fits customer's need.

Drop-down glass door is easy to clean.

Partitioned workbench is easy to sterilize and clean.

Features

- The main filter uses damp-proof, fire-proof glass fiber HEPA filter. Filtering efficiency for $\geq 0.3\mu\text{m}$ particulate matter is $\geq 99.995\%$ for cleaner air and safer samples.
- Dual DC fans operate with lower noise and better air flow uniformity.
- LCD screen displays various parameters and clear operational conditions.
- UV lamp can be set with one single key to activate/deactivate automatically at specified sterilization intervals from 0min to 24h, to minimize the waiting time.
- The product features a system for interlocking the ultraviolet sterilization, fluorescent lamp, front window and fan motor with each other.
- Multiple audible and visual alarms: hardware malfunction alarm, operating parameter overrun alarm, filter/UV lamp lifecycle ending alarm, etc.
- Patented water-proof receptacle timer: two water-proof receptacles can be automatically powered on/off by the timer.

Ergonomic Design

- 10° angled front design provides a comfortable work space for operators.
- Adjustable stand (680-900mm) with recessed mechanism to reduce risk of contamination.
- Universal caster for convenient moving.
- Drop-down front window design for easier cleaning of the upper edge of glass.
- Removable armrest reduces fatigue and does not interfere with air inflow.
- Optional accessories include water valves, air valves, electronic sash window and electric adjustable stand

Structure and Dimensions

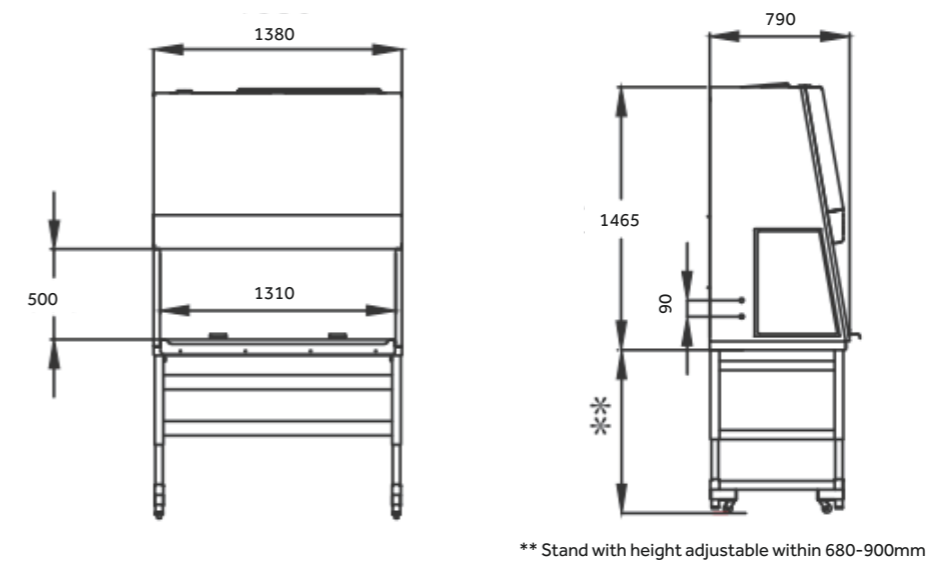

Specifications

Model	Working Voltage & Frequency (V/Hz)	Filter Typical Efficiency	Downflow Velocity (m/s)	Inflow Velocity (m/s)	Fluorescent Lamp Intensity (Lux)	Internal Dimension (W*D*H)	External Dimension (W*D*H)	External Dimension Without Arm Rest (W*D*H)	Packing Dimension (W*D*H)	Support Stand	Certification
HR1200-IIA2-S	220/50/60	HEPA H14, 99.995% @ 0.3µm	0.30	0.45	≥ 1000	1310*620*630 (mm) 51.6*24.4*24.8 (in)	1380*850*2160 (mm) 54.3*33.5*85.0 (in)	1380*790*2160 (mm) 54.3*31.1*85.0 (in)	1470*920*1690 (mm) 57.9*36.2*66.5 (in)	680-900 (mm) adjustable height	CE, TÜV SUD Mark, NMPA (CFDA)
HR900-IIA2-S	220-240-50/60	ULPA, U15, 99.9995% @ 0.12µm	0.54(90)	0.55	≥ 1300	936*620*635 (mm) 36.9*24.4*25.0 (in)	1002*796*856*1485 (mm) 39.5*31.3*33.7*58.5 (in)	/	1070*895*1680 (mm) 42.1*35.2*66.1 (in)	680-900mm (26.8-35.4") adjustable height	CE, UKCA

Biological Safety Cabinet: Classic Series, Type A2

Product Advantages

- Digital LCD screen
- Real-time display of key parameters: down-flow velocity, inflow velocity, airflow volume, static pressure, negative pressure, accumulative running time of fan, accumulative running time of UV lamp, and remaining life of filter
- Audible and visual alarms for abnormal parameters
- Clock setting function
- UV lamp sterilization function
- Quality 304 stainless steel work surface without screws, no accumulation of contaminant
- Dismountable air in-flow plate, easy to clean and sterilize
- The internal walls on three sides of operation area is constructed by a single plate, and the 12mm arc angle corner for optimal cleaning
- The volume of liquid tank is over 4L, equipped with outlet valve for convenient cleaning and maintenance
- Patented air flow blocking technology is adopted at the upper edge and both edges of front window to eliminate the exposure of microorganism.



Ergonomic

• UV Lamp One-touch Operation

The UV Lamp can remember the user's settings and use habits, and can be preset with a certain startup delay just by pressing down one key, to save more time for the user.

• Universal Casters with Built-in Threaded Supporting Legs

The stand is designed with universal casters for manoeuvrability and built-in treaded supporting legs help prevent contamination.

Professional

• Digital display of operating parameters

Real-time digital display of down flow, inflow, exhaust volume, filter remaining life, UV lamp remaining life, negative pressure and positive pressure.

Safe

• Abnormal operation condition alarm

Audible and visual alarms in form of voice or text will be present when air turbulence level exceeds 20% and door height (high or low).

• Filter end-of-life reminder

Pressure transducer monitors the resistance variation of filter to determine the remaining life of filter and reminds the user by warning when the remaining life is below 10%.

• UV lamp end-of-life reminder

The microcomputer records service times of the UV lamp and will alert the user to replace the UV lamp when its remaining life is less than 10%.

• Interlocking feature to ensure high safety and reliability

- Patented technology: UV lamp interlocking control
UV lamp, front window, fan and interior light operation are interlocked together to protect against harmful UV rays and to prevent leakage of microorganisms.
- For Type A2 safety cabinet with internal & external fans interlocked, the external fan will be activated first when the safety cabinet is powered on, and the internal fan will be deactivated first when the safety cabinet is powered off. When the air inflow is lower than the limit, the internal fan will be deactivated and the external fan will continue working, while users are alerted by the audible and visual alarms. When the internal fan is deactivated during working, the external fan will continue working, accompanied with audible and visual alarms.

Key Components

• Ultra-Low Particulate Air (ULPA) Filter (U15)

- The ULPA filter made from moisture-proof and fireproof glass fibers with an efficiency up to 99.9995% filtering 0.12 μ m solid particles, fully meeting the cleanliness requirements of USA FED STD 209E Grade 1 (and ISO 14644-1 Grade 3).
- ULPA filter can supply vertical air flows to the workbench, preventing the samples from being contaminated.
- The filter can be scanned point by point to ensure high performance, reliability and safety.

• Maintenance-free fan system

- Forward centrifugal fan with air inflows at both sides of motors reduces to a very low level
- The fan self-cools to ensure high reliability and low energy consumption
- Optimal balance between air supply and energy consumption
- Stable air flow for safety cabinet upon precise control of fan operation

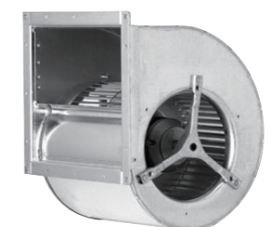
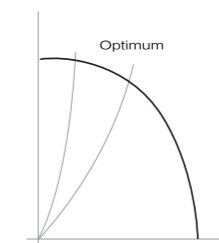
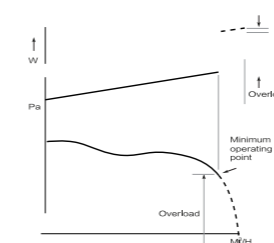

Biological Safety Cabinet: Classic Series, Type A2

Product Configuration

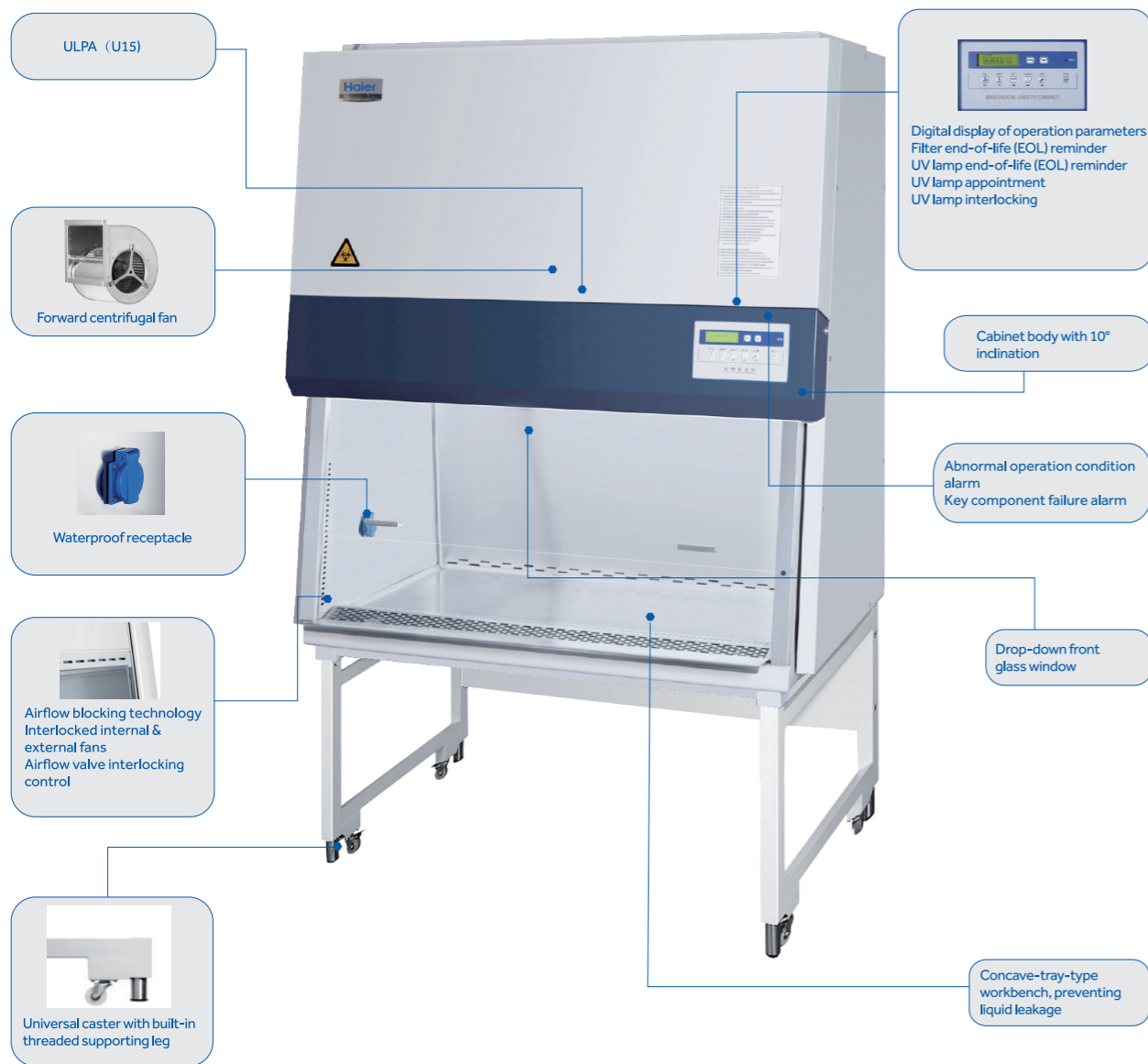

Specifications

Model	Working Voltage&Frequency (V/Hz)	Downflow Velocity (m/s)	Inflow Velocity (m/s)	Fluorescent Lamp Intensity(Lux)	Net/Gross Weight	Interior Dimension (W*D*H)	Exterior Dimension (W*D*H)	Packing Dimension (W*D*H)	Container load (20'/40'/40'H)	Support Stand	Certification
HR30-IIA2	220/50/60	0.3	0.53	≥1100	220/248(kg)	900*610*680(mm)	1100*820*2200(mm)	1155*905*1720(mm)	10/20/20	680mm	NMPA (CFDA), CE, TUV SUD Mark
					485.0/546.7(lbs)	35.4*24.0*26.8(in)	43.3*32.3*86.6(in)	45.5*35.6*67.7(in)			
HR40-IIA2	115/60	0.28	0.55	≥1200	258/305 (kg)	1167*610*680(mm)	1360*820*2200(mm)	1415*905*1720(mm)	8/16/16	680mm	/
					568.8/672.4(lbs)	45.9*24.0*26.8(in)	53.5*32.3*86.6(in)	55.7*35.6*67.7(in)			
	220/50/60	0.3	0.53	≥1200	258/305 (kg)	1167*610*680(mm)	1360*820*2200(mm)	1415*905*1720(mm)	8/16/16	680mm	NMPA (CFDA), CE, TUV SUD Mark
					568.8/672.4(lbs)	45.9*24.0*26.8(in)	53.5*32.3*86.6(in)	55.7*35.6*67.7(in)			

Adjustable Stands (Optional): 680-900mm adjustable height

Optional components

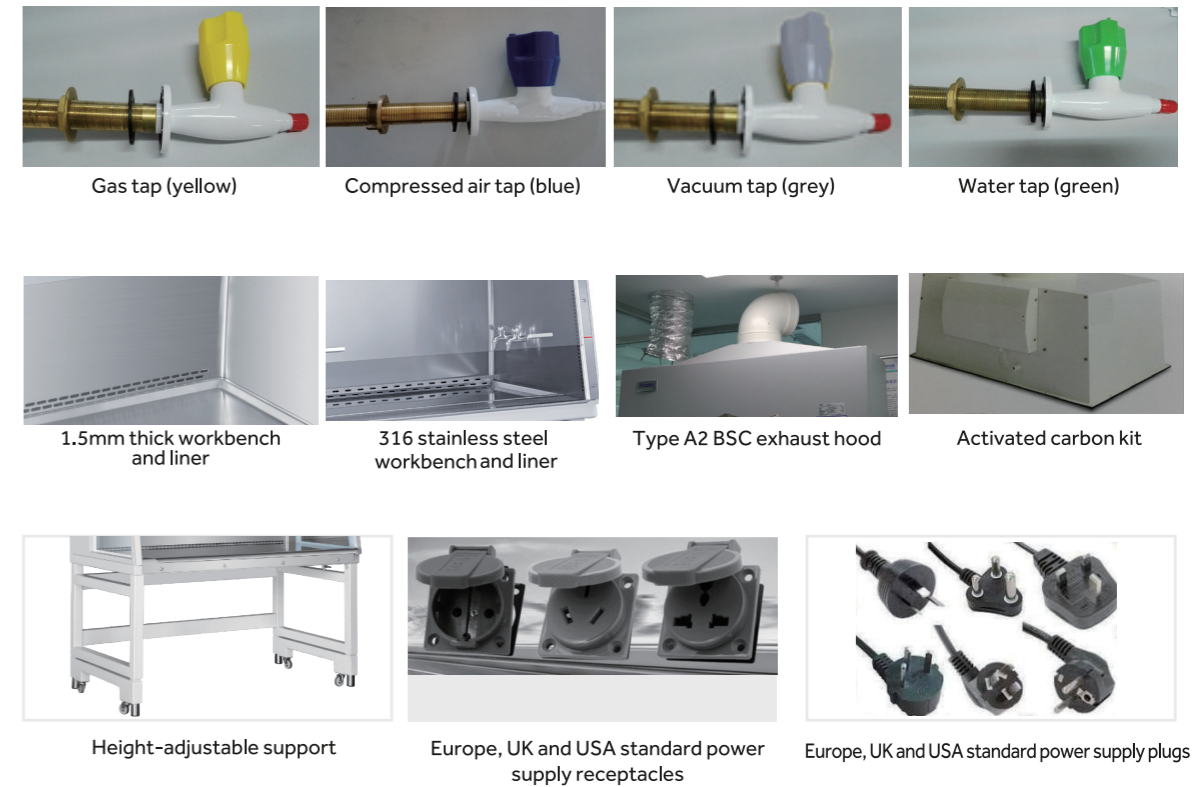

Biological Safety Cabinet: Classic Series, Type B2

Product Advantages



- 100% exterior exhaust
- 4m corrosion-resistant corrugated hose (standard)
- Haier exterior exhaust fan (optional)
- Interlocking between BSC and exterior exhauster, enabling remote control of exterior exhauster parameters with BSC

Model		HR40-IIB2
Working Voltage&Frequency(V/Hz)		220/50/60
Downflow Velocity		0.28
Inflow Velocity		0.55
Fluorescent Lamp Intensity (Lux)		≥1200
Net/Gross Weight (approx)	kg	252/308
	lbs	555.6/679.0
Internal Dimension (W*D*H)	mm	1167*610*680
	in	45.9*24.0*26.8
External Dimension (W*D*H)	mm	1360*790*2400
	in	53.5*31.1*94.5
Packing Dimension (W*D*H)	mm	1415*905*1910
	in	55.7*35.6*75.2
Container Load(20'/40'/40'H)		8/16/16
Certification		NMPA(CFDA), CE, TUV SUD Mark
Support Stand		680mm

External exhaust fan is optional. The size information is as follows:

Adjustable Stands (Optional): 680-900mm adjustable height

Model	Net/Gross Weight (kg)	External Dimension (W*D*H)(mm)	Packing Dimension (W*D*H)(mm)
HR40-IIB2 (External exhaust fan assembly)	25/30	640*480*350	770*710*510

Optional components



Gas tap (yellow)

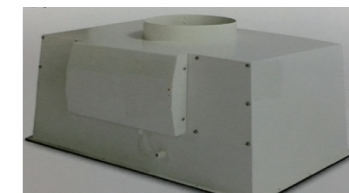

Activated carbon kit



Compressed air tap (blue)



Europe, UK and USA standard power supply plugs



Vacuum tap (grey)



Europe, UK and USA standard power supply receptacles



Water tap (green)



Height-adjustable support



1.5mm thick workbench and liner



316 stainless steel workbench and liner

Biological Safety Cabinet: Animal Containment Workstation

Product Advantages

Applicable for laboratory animal operations (surgery, weighing, etc.) in experimental animal centers of scientific research institutions, hospitals, colleges and universities, or experimental animal research and development projects and breeding institutions

Low Maintenance Costs

Experimental animal hair and debris are captured to eliminate the impact of hair debris and other debris on the service life of the fans and filters which ensures the cabinet to be more durable

The Dual System eEnsures Maximum Safety

Each independent-controlled down flow and inlet airflow system is designed with dual fans, which ensures the stable airflow in the cabinet even if the pre-filter is 50% blocked. In the case of either damage to either fan, the air supply and exhaust system ensure safe air and protection

Sectioned Pre-filter

The interior of the sectioned pre-filter is easy to clean, and the pre-filter with a rear-mounted work surface is designed in sections, meaning the filter is easy to be disassembled and sterilized as needed

Stable Laminar Flow Offers Safety

When the air velocity is abnormal, the intelligent constant air speed design automatically adjusts the fan speed according to the current air velocity to ensure that the air speed is within the standard range

Product Features

Safety interlock

Ultraviolet lamp, front window, fans, and lamps are interlocked to eliminate hidden dangers of ultraviolet and microorganism leakage

Traceable

The work area in the cabinet is monitored by camera and the images are stored for future reference (optional)

Real-time status display

The digital display screen displays in real time the flow rate of downflow and inflow airflow, the volume of discharged air, the temperature and humidity of the working area, the remaining service life of the filter, the UV lamp, the pressure in the negative pressure area, and positive pressure area. In case of abnormal operations, alarm prompts will be sent

Electric foot switch door opener

When it is inconvenient to open the safety cabinet door with both hands, the electric door can be opened by foot switch (optional)

Specifications

Model	Working Voltage&Frequency (V/Hz)	Filter Typical Efficiency	Downflow Velocity (m/s)	Inflow Velocity (m/s)	Fluorescent Lamp Intensity(Lux)	Internal Dimension (W*D*H)	External Dimension (W*D*H)	External Dimensions Without Arm Rest (W*D*H)	Packing Dimension (W*D*H)	Support Stand	Certification
HR1500-IIA2-DW	/	/	0.30	0.53	≥1100	1530*600*653 (mm)	1636*790*2170 (mm)	/	1700*925*1715 (mm)	/	/

Clean Bench (Laminar Flow) Safe and Reliable

Product Advantages

- Cleanliness better than Level 100:**
 Fire retardant glass fiber HEPA with filtration efficiency of 99.99%@0.3μm, to ensure optimal air cleanliness, meets and exceeds Grade 5 ISO 14644.1 and Grade 100 FED STD 209E standard for safer and cleaner work area
- Intelligent interlocking:**
 Intelligent linkage and interlocking design between interior light and UV lamp to prevent incorrect operation
- Pre-cleaning function:**
 Pre-cleans the work space before the first use, to assist the user in protecting the samples during experiments
- Patented UV sterilization operation:**
 The timing startup operation of UV sterilization upon our patented technology provides the user more free time to improve working efficiency
- Patented UV sterilization power-on delay:**
 After the UV lamp button is pressed down, sound-light alarm will remind the operator to leave immediately, and the UV lamp will be powered on after a delay of 10s to protect the operator against UV radiation

Product Configuration -- Horizontal Airflow



Specifications

Model	Working Voltage/Frequency (V/Hz)	Fluorescent Lamp Intensity(Lux)	Net/Gross Weight (approx)	Interior Dimension (W*D*H)	Exterior Dimension (W*D*H)	Packing Dimension (W*D*H)	Container load (20'/40'/40'H)	Support Stand	Certification
HCB-900V	220/50	≥300	115/145(kg)	900*530*520(mm)	970*630*1730(mm)	1105*745*1280(mm)	15/33/33	755mm high chassis	CE, TUV SUD Mark NMPA(CFDA)
			254/319(lbs)	35,4*20,9*20,5(in)	38,2*24,8*68,1(in)	43,5*29,3*50,4(in)			
HCB-1300V	115/60	≥300	145/171(kg)	1300*530*520(mm)	1370*630*1730(mm)	1505*745*1280(mm)	10/25/25	755mm high chassis	/
			320/376(lbs)	51,2*20,9*20,5(in)	53,9*24,8*68,1(in)	59,3*29,3*50,4(in)			
	220/50	≥300	145/171(kg)	1300*530*520(mm)	1370*630*1730(mm)	1505*745*1280(mm)	10/25/25	755mm high chassis	CE, TUV SUD Mark NMPA(CFDA)
			320/376(lbs)	51,2*20,9*20,5(in)	53,9*24,8*68,1(in)	59,3*29,3*50,4(in)			
HCB-1600H	220/50/60	≥1000	165/214(kg)	1710*550*750(mm)	1780*790*1960(mm)	1865*940*1370(mm)	6/12/12	765mm high chassis	CE, TUV SUD Mark NMPA(CFDA)
			363,7/471(lbs)	67,3*21,7*29,5(in)	70,1*31,1*77,2(in)	73,4*37,0*53,9(in)			

Product Configuration -- Vertical Airflow



Clean Bench (Laminar Flow)

Safe and Reliable | EU Medical Device Certified

Product Advantages

- Positive pressure chamber design ensures air velocity uniformity and forms effective seal
- Ergonomic cabinet design with a 10° inclination, to improve user comfort during operation
- The worksurface is made of easy-to-clean, high-quality, anti-corrosion 304 stainless steel
- The front glass sash window and the left & right side glass panels are all non reflective tempered UV glass maximise natural light whilst being easy to clean
- Equipped with access ports on left and right sides, easy and convenient to mount valves such as gas supply



Product Information

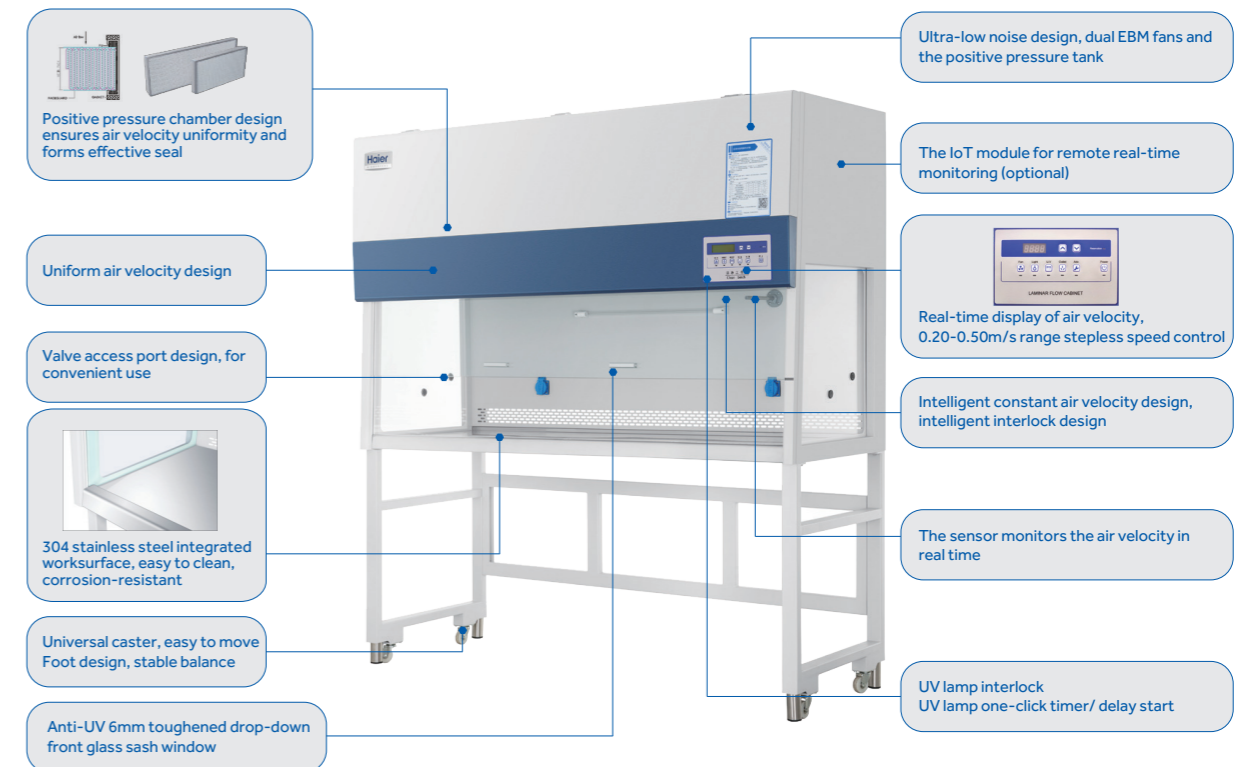

Product Features

- High performance energy saving and environmental protection fan, low energy consumption, high efficiency
- Real-time display filter life and fan, UV lamp running time, convenient and safe
- UV lamp sterilization timer design, any time self-service UV lamp open and close
- In line with YY/T 1539-2017, JG/T 292-2010, EN12469, EN1822 and other standards
- Operating area cleanliness to ISO 14644-1 class 4
- Intelligent interlock design, to shield the risk of mis-operation, the operating sash is manufactured with UV light, LED light, and fan
- Users can adjust the air velocity in the range of 0.20-0.50m/s with the accuracy of 0.01m/s
- IoT technology to achieve remote online monitoring (optional)
- Intelligent constant air velocity and interlock design
- Ultra-low noise design, positive pressure tank with dual EBM fans

Specifications

Model	Average Velocity (M/S)	Lighting Intensity (Lux)	Net/Gross Weight (kg/lbs)	Exterior Dimension (W*D*H)(mm)	Interior Dimension (W*D*H)(mm)	Packing Dimensions (W*D*H)(mm)	Container Load (20'40'40'H)
HCB-900VS	0.20-0.50	≥400	140/166 308.6/366	970*640*1820	900*510*550	1083*772*1467	15/33/33
HCB-1300VS	0.20-0.50	≥600	180/232 397/511.5	1370*640*1820	1300*510*550	1470*810*1290	11/22/22
HCB-1600VS	0.20-0.50	≥1000	202/260 445.3/573	1670*640*1820	1600*510*550	1760*810*1285	7/14/14

Optional Components

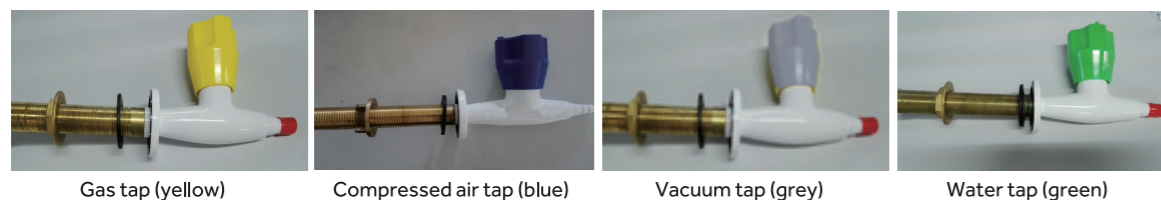

Gas tap (yellow)

Compressed air tap (blue)

Vacuum tap (grey)

Water tap (green)

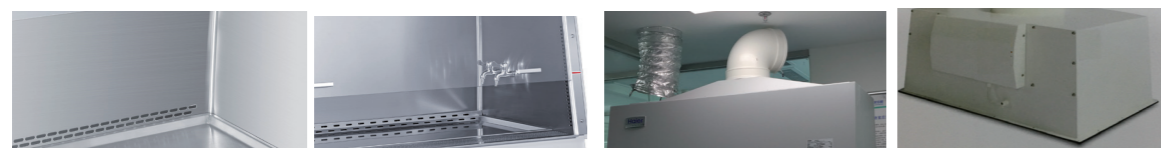

1.5mm thick workbench and liner

316 stainless steel workbench and liner

Type A2 BSC exhaust hood

Activated carbon kit

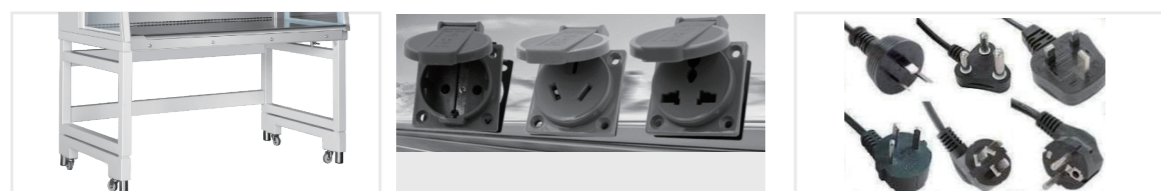

Height-adjustable support

Europe, UK and USA standard power receptacles

Europe, UK and USA standard power supply plugs

Hydrogen Peroxide Disinfector: HGYX-Y100

Scope of Application

The product is applicable to biosafety cabinets, pass-through box, incubator, airlocks and channels, flow cytometer, PIVAS, microbiological incubators, robot arm work bins, desktop sealed operating bins, mobile biosafety vehicles, ambulances, first aid inflatable tents and military mobile experimental isolators as key examples.

Safety

Safe and secure, non-toxic, without other side effects by using hydrogen peroxide as disinfectant

High Penetrability

Small diameter particles of strongpenetrability can penetrate HEPA filters

Easy to Clean

Electrostatic epoxy powder coated, which is corrosion resistant and easy to clean

Quick Connection

Standard DN quick connector, which can be quickly connected to the equipment

Portable

Compact size, light weight and convenient to handle and carry

High Disinfection Level

Higher disinfection level with less consumption of hydrogen peroxide

High-efficiency

Disinfection time is less than 1 hour. The operator can reoperate in 0.5 to 1 hour's ventilation after disinfection

Ergonomic Design

- With small volume and total weight of 12kg, it is easy to carry and store
- Pre-warning function of the program: sound and light alarm before the disinfection program starts
- It takes less than 2 hours for total disinfection, saving time
- One-button disinfection, no other operation is needed during the disinfection

Product Configuration



Hydrogen Peroxide Disinfector: HGYX-Y500

Scope of Application

The product is applicable to high-risk areas in medical institutions, biosafety laboratories, intensive care units, operating rooms, laboratories, infection wards, general wards, biopharmaceutical enterprises, public areas, and places with disinfection requirements.

Product Advantages

Larger Disinfection Space

The disinfection coverage is up to 300m³.

High Disinfection Level

It provides a 6-log sporicidal kill on exposed surfaces.

High-efficiency

It takes less than 3 hours for total disinfection, saving time.

Eco Friendly 7%~7.5% Hydrogen Peroxide Sterilizing

Safe and secure, non-toxic, without other side effects by using hydrogen peroxide as disinfectant.

Ergonomic Design

Compact and wheeled unit, easy to move and to store after use.

Ergonomic Design

PIR Sensor Technology

With the PIR sensor, equipment does not work if any persons are detected.

Multiple Alarms

Audible and visual alarm functions: high/low temperature alarm, high and low humidity alarm, and residual liquid volume alarm.

Energy Saving and Environmental Protection

Using a hydrogen peroxide solution, it decomposes into water and oxygen after disinfection.

Unique Patented Nozzle

The spray system has unique patented sprinkler head and the spray particle size average is $\leq 3\mu\text{m}$.

Real Time Detection of Temperature and Humidity

Real time monitoring and recording of data during operation.

USB Interface

Capable of storing more than 10 years of data.

Product Information



Specifications

Model	Power Supply (V)	Power (W)	Vaporization Rate (ml/min)	Maximum Vaporization (ml)	Disinfection Time	Disinfection Efficiency	Net/Gross Weight (kg)	Exterior Dimensions (W*D*H)(mm)	Packing Dimensions (W*D*H)(mm)
HGYX-Y100	220	700	1-10	500	<2h	>99.9%	12/15	300*300*350	410*405*495
HGYX-Y500	220	1100	15-25	5000	<4h	>99.9%	30/35	350*350*950	590*430*1100

Standard Operation Procedures for Biological Safety Cabinet

A Biological Safety Cabinet (BSC) is important for laboratory biosafety protection. To ensure effective biosafety protection the cabinet MUST be used in accordance with standard use guidelines. The following provides guidance on good practices and basic procedures for BSC use to ensure optimal performance and protection.

Basic Operation Procedures

- 1) Preparation
- 2) Power-on
- 3) Experiment operation
- 4) Cleaning
- 5) Power-off

Front Window Important Information

- 1) When BSC is not used, the front window should be completely closed. This prevents aerosol leakage inside the cabinet. The front window glass also protects the operators when using UV lamps.
- 2) When BSC is used, the front window should be at the normal operating height at all times. When the fan is in operation, the position of the front window should not be changed from the normal height, unless any instruments or related items are placed in or removed from BSC.
- 3) The alarm will be activated whenever the front window is moved from the normal operating height.
- 4) The front window can be opened to the maximum position so as to load/unload objects/instruments. When the front window is fully open, the front window alarm will be activated. After placing the object/instrument, the front window should be fixed at the working position in time.

Preparation for Use

- 1) Prepare materials/instruments
- 2) Start BSC: press the power switch for 3 seconds to energize BSC, and switch on the UV lamp for 30 minutes for sterilization (use the UV lamp appointment function).
- 3) After complete the sterilization process, open the front window glass to the working position, and wait for the "Self-cleaning" countdown for 3 minutes. (The fan and the interior light are automatically turned on when the glass door is opened).
- 4) Wash your hands thoroughly with sterilized soap. Wear gloves for protection. Gloves should be placed outside the wrist of the lab coat rather than inside. Operators are required to wear two layers of gloves when performing high risk experiments.
- 5) Wear a clean long-sleeved lab coat. The experimental robe tied at the chest and back (similar to surgical gowns) can provide better protection than traditional lab coats. Disposable laboratory suit is required for high-risk work.
- 6) Adjust the operator's seat to the most comfortable position. It is recommended to use a height adjustable experiment seat.
- 7) Fully open the front window. Thoroughly clean the surface of the work area, the side walls, the rear wall, and the inner surface of the front window with 70% alcohol (depending on available BSC materials, or using other sanitizers), while clean the surfaces of UV lamp and power receptacle.

Note: Do not use chlorine-containing sanitizers as this may cause corrosion on the stainless steel surface.

- 8) Clean the surface of material/instrument before placing it in the work area. When placing materials and instruments in BSC, minimize the cross-contamination in a reasonable manner, such as placing them in sub-areas by placing clean samples on the left and potentially contaminated items on the right, which is more effective to prevent cross infection.
- 9) Keep materials and instruments at least 10cm from the front window.
- 10) After all materials and instruments are organized in a proper order, adjust the front window to the normal operating height, and let the fan run for another 3 minutes to discharge the pollutants in the working area.
- 11) Minimize any indoor activities (walking, opening/closing doors, etc.), because external airflow disturbances may affect the airflow inside BSC, impairing the safety performance of BSC.

Cleaning and power-off

- 1) Throw all biohazardous waste into biosafety bags (including the outer layers of double gloves). Seal the safety bag and dispose it properly. (If necessary, dispose the waste with a pressure-cooker.)
- 2) Clean the surfaces of all materials and instruments with 70% IPA (isopropyl alcohol solution) before being removed from BSC. It is recommended to keep the fan running during the cleaning process.
- 3) Wipe the surface of the work area, side walls, back wall, drain, etc. with a clean cloth and then scrub with water and a mild detergent. Do not scrub with any chlorine-containing detergent.
- 4) Rinse with water and wipe the detergent with a clean cloth until there is no residual detergent.
- 5) Keep the fan running for another 3 minutes to clean the work area, and then close the front window (the fan and light will automatically turn off). Turn on the UV lamp to sterilize the inside surfaces of BSC for 30 minutes. The use of UV lamp overnight will shorten its life. It is recommended to use the UV light one-touch appointment function of Haier biological safety cabinet. The UV lamp life of Haier biological safety cabinet is 8000 hours. In general, the UV lamp is changed once a year to maintain its efficacy.

- Eyes and skin should not be directly exposed to ultraviolet light. Close the front window before turning on the UV lamp.
- The UV lamp only has a bactericidal effect on the place where the light is irradiated, and it is not expected to only rely on the sterilization effect of UV lamp.
- About the disinfectant
 - a) For stainless steel, the disinfectant can be used as long as it is a chlorine-free germicide.
 - b) If the surface is coated with powder, all commonly used germicides can be used. Different types of germicides can be used according to the safety protection requirements during the operation time of BSC.

- 6) Carefully take off the lab coat and gloves, and wash the hands thoroughly with sterilized soap.

- 7) In the following circumstances, the user should keep in mind the characteristics of the pathogen used, to ensure the correct safety protection of BSC. Use formaldehyde purification equipment for fumigation (or adopt effective gas disinfection):

- Move/reposition BSC
- Change the type of work in BSC
- Before entering the contaminated area for maintenance (e.g. replacing the filter)

Maintenance plan

Maintenance tasks to be executed:

Maintenance tasks	Daily	Weekly	Monthly	Yearly
Clean the working area	●	●	●	●
Clean the glass and external surfaces	●	●	●	●
Sterilize inside BSC (UV lamp)	●	●	●	●
Check the functions	●	●	●	●
Replace the UV lamp				●
Conduct annual performance examination				●
Interior light (fluorescent lamp)	Replace after use for 20,000h or find any faults			
Filter	Replace after use for 3-5 years, as the case may be, or find unacceptable during the annual examination			

BSC Operation Important Precautions

- 1) Before any experiment, the user should place the front window to the normal operating height.
- 2) If any alarm indicator is flashing, stop working immediately and close the glass door for trouble shooting. Air sensor tracks the air down flow velocity and inflow velocity as indicated by the LCD display. When the inflow velocity drops below the failure point, the abnormal alarm for air flow is activated.
- 3) Make sure that the front and rear airflow grids are not blocked by your arms or other objects.
- 4) Work as much as possible from a clean work area, and then gradually move to the side where the pollutant or toxic substance is placed. Operate in accordance with the principle of isolation from clean to contaminated materials/instruments. When using samples placed in a safety cabinet, only one type can be used at a time. Cover the sample used before using another sample.
- 5) When working in BSC, operate as close as possible to the inside of BSC, at least 15cm away from the front air inflow grid. Move open tubes and bottles horizontally if possible to avoid spillage. Immediately after use, place empty test tubes and test bottles in the collection bag in BSC.
- 6) Sterilize the inoculating loop to avoid cross-infection of biological materials. It is recommended to use an infrared sterilizer. Try not to use Bunsen burners as much as possible. Alcohol lamps are not allowed.
- 7) Perform a disinfection process for the surface when removing contaminants from BSC.
- 8) Be careful when you move or remove objects from and into BSC. Slowly move the arm from and into the working area of BSC perpendicularly to the opening direction of the working area.
- 9) Cover the workbench surface and the water collection basin with a disinfectant, and wait 10 to 15 minutes. Wipe off excess germicide with a sponge or cloth soaked with a purifying agent.
- 10) Place the germicide discharged from BSC in a suitable container and use an autoclave. When the effluent is cleaned, replace the outer gloves with new ones. Allow the cabinet to vent for a few minutes and autoclave all contaminants (including gloves, cloth and sponge).
- 11) When using an aerosol-generating instrument, place it inside BSC as far as possible from the test sample.
- 12) Keep clean materials at least 15 cm away from aerosol generating instruments/objects, to minimize the cross-contamination.
- 13) Cover the vessel/sample with a lid/sample tray to prevent it from being impacted by the down flow.
- 14) Avoid using a centrifuge, mixer, ultrasonic washer or other devices that can generate turbulent airflows. If you have to use these devices, keep them away from the backpane of the BSC.
- 15) If a vacuum pipe is used, a cartridge filter should be placed between the vacuum pump and the cock valve, to protect the building's vacuum system from biological hazards.

Summary of Specifications

Model	Working Voltage&Frequency (V/Hz)	Downflow Velocity(m/s)	Inflow Velocity(m/s)	Fluorescent Lamp Intensity(Lux)	Net/Gross Weight(approx)	Interior Dimension (W*D*H)	Exterior Dimension (W*D*H)	External Dimensions Without Arm Rest (W*D*H)	Packing Dimension (W*D*H)	Container Load (20'/40'/40'H)	Support Stand	Certification
IoT Series Biological Safety Cabinet												
HR1200-IIA2-N	100-230/50/60	0.35	0.53	1323	275/335 (kg)	1230*600*650 (mm)	1340*850*2160 (mm)	1340*790*2160 (mm)	1400*900*1710 (mm)	8/16/16	680	UL, NSF
					617/750 (lbs)	48.4*23.6*25.6 (in)	52.8*33.5*85 (in)	52.8*31.1*85 (in)	55.1*35.4*67.3 (in)			
HR1800-IIA2-N	100-230/50/60	0.35	0.53	1292	375/460 (kg)	1830*600*650 (mm)	1940*850*2160 (mm)	1940*790*2160 (mm)	2000*900*1710 (mm)	6/12/12	680	UL, NSF
					827/1014 (lbs)	72.0*23.6*25.6 (in)	76.4*33.5*85 (in)	76.4*31.1*85 (in)	78.7*35.4*67.3 (in)			
HR1200-IIA2-X	220/50/60	0.3	0.45	1317	280/340(kg)	1230*600*655(mm)	1336*845*2120(mm)	1336*790*2120(mm)	1400*925*1665(mm)	8/16/16	680-900mm adjustable	NMPA(CFDA), CE,TUV SUD Mark
					617.3/749.6(lbs)	48.4*23.6*25.8(in)	52.6*33.3*83.5(in)	52.6*31.1*83.5(in)	55.1*36.4*65.6(in)			
HR1500-IIA2-X	220/50/60	0.3	0.45	1396	320/400(kg)	1530*600*655(mm)	1636*845*2120(mm)	1636*790*2120(mm)	1700*925*1665(mm)	6/12/12	680-900mm adjustable	NMPA(CFDA), CE,TUV SUD Mark
					705.5/881.8(lbs)	60.2*23.6*25.8(in)	64.4*33.3*83.5(in)	64.4*31.1*83.5(in)	66.9*36.4*65.6(in)			
HR1800-IIA2-X	220/50/60	0.3	0.45	1133	380/465(kg)	1830*600*655(mm)	1936*845*2120(mm)	1936*790*2120(mm)	2000*925*1665(mm)	6/12/12	680-900mm adjustable	NMPA(CFDA), CE,TUV SUD Mark
					837.8/1025.1(lbs)	72.0*23.6*25.8(in)	76.2*33.3*83.5(in)	76.2*31.1*83.5(in)	78.7*36.4*65.6(in)			

Model	Working Voltage & Frequency (V/Hz)	Downflow Velocity (m/s)	Inflow Velocity (m/s)	Fluorescent Lamp Intensity (Lux)	Net/Gross Weight (approx)	Interior Dimension (W*D*H)	Exterior Dimension (W*D*H)	External Dimensions Without Arm Rest (W*D*H)	Packing Dimension (W*D*H)	Containerload (20'/40'/40'H)	Support Stand	Certification
Biological Safety Cabinet												
HR30-IIA2	220/50/60	0.3	0.53	≥1100	220/248 (kg)	900*610*680 (mm)	1100*820*2200 (mm)	/	1155*905*1720 (mm)	10/20/20	680mm	NMPA (CFDA), CE, TUV SUD Mark
					485.0/546.7 (lbs)	35.4*24.0*26.8 (in)	43.3*32.3*86.6 (in)	45.5*35.6*67.7 (in)				
HR40-IIA2	115/60	0.28	0.55	≥1200	258/305 (kg)	1167*610*680 (mm)	1360*820*2200 (mm)	/	1415*905*1720 (mm)	8/16/16	680mm	/
	220/50/60	0.3	0.53	≥1200	568.8/672.4 (lbs)	45.9*24.0*26.8 (in)	53.5*32.3*86.6 (in)	55.7*35.6*67.7 (in)				
HR40-IIA2	220/50/60	0.3	0.53	≥1200	258/305 (kg)	1167*610*680 (mm)	1360*820*2200 (mm)	/	1415*905*1720 (mm)	8/16/16	680mm	NMPA (CFDA), CE, TUV SUD Mark
					568.8/672.4 (lbs)	45.9*24.0*26.8 (in)	53.5*32.3*86.6 (in)	55.7*35.6*67.7 (in)				
HR40-IIA2	220/50/60	0.28	0.55	≥1200	252/308 (kg)	1167*610*680 (mm)	1360*790*2400 (mm)	/	1415*905*1910 (mm)	8/16/16	680mm	NMPA (CFDA), CE, TUV SUD Mark
					565.6/679 (lbs)	45.9*24.0*26.8 (in)	53.5*31.1*94.5 (in)	55.7*35.6*75.2 (in)				
HR900-IIA2	220/50	0.33	0.55	≥900	270/293 (kg)	920*620*650 (mm)	1080*845*2160 (mm)	1080*790*2160 (mm)	1145*920*1690 (mm)	12/24/24	680-900mm adjustable	NMPA (CFDA), CE, TUV SUD Mark
					595.3/646 (lbs)	36.2*24.4*25.6 (in)	42.5*33.3*85.0 (in)	42.5*31.1*85.0 (in)	45.1*36.2*66.5 (in)			
HR900-IIA2-D	220-240-50/60	0.30 (60)	0.55	≥1300	290/310 (kg)	936*620*635 (mm)	1002*796(856)*1485 (mm)	/	1070*895*1680 (mm)	12/24/24	680-900mm (26.8-35.4") adjustable height	CE, UKCA
					639/705 (lbs)	36.9*24.4*25.0 (in)	39.5*31.3(33.7)*58.5 (in)	42.1*35.2*66.1 (in)				
HR900-IIA2-S	220-240-50/60	0.54 (90)	0.55	≥1300	290/310 (kg)	936*620*635 (mm)	1002*796(856)*1485 (mm)	/	1070*895*1680 (mm)	12/24/24	680-900mm (26.8-35.4") adjustable height	CE, UKCA
					639/705 (lbs)	36.9*24.4*25.0 (in)	39.5*31.3(33.7)*58.5 (in)	42.1*35.2*66.1 (in)				
HR1200-IIA2	220/50	0.34	0.55	≥900	320/339 (kg)	1220*620*650 (mm)	1380*845*2160 (mm)	1380*790*2160 (mm)	1470*920*1690 (mm)	8/16/16	680-900mm adjustable	NMPA (CFDA), CE, TUV SUD Mark
					705.5/747 (lbs)	48.0*24.4*25.6 (in)	54.3*33.3*85.0 (in)	54.3*31.1*85.0 (in)	57.9*36.2*66.5 (in)			
HR1200-IIA2-D	220/50/60	0.30	0.45	≥1000	320/339 (kg)	1310*620*630 (mm)	1380*850*2160 (mm)	1380*790*2160 (mm)	1470*920*1690 (mm)	8/16/16	680-900mm adjustable	NMPA (CFDA), CE, TUV SUD Mark
					705.5/747 (lbs)	51.6*24.4*24.8 (in)	54.3*33.3*85.0 (in)	54.3*31.1*85.0 (in)	57.9*36.2*66.5 (in)			
HR1200-IIA2-S	220/50/60	0.30	0.45	≥1000	320/339 (kg)	1310*620*630 (mm)	1380*850*2160 (mm)	1380*790*2160 (mm)	1470*920*1690 (mm)	8/16/16	680-900mm adjustable	NMPA (CFDA), CE, TUV SUD Mark
					705.5/747 (lbs)	51.6*24.4*24.8 (in)	54.3*33.3*85.0 (in)	54.3*31.1*85.0 (in)	57.9*36.2*66.5 (in)			
HR1500-IIA2	220/50	0.31	0.55	≥900	360/393 (kg)	1520*620*650 (mm)	1680*845*2160 (mm)	1680*790*2160 (mm)	1755*920*1690 (mm)	6/12/12	680-900mm adjustable	NMPA (CFDA), CE, TUV SUD Mark
					793.7/866.4 (lbs)	59.9*24.4*25.6 (in)	66.1*33.3*85.0 (in)	66.1*31.1*85.0 (in)	69.1*36.2*66.5 (in)			
HR1500-IIA2-DW	/	/	/	≥1100	350/400 (kg)	1530*600*653 (mm)	1636*790*2170 (mm)	/	1700*925*1715 (mm)	6/12/12	/	/

Model	Working Voltage & Frequency (V/Hz)	Fluorescent Lamp Intensity (Lux)	Net/Gross Weight (approx)	Interior Dimension (W*D*H)	Exterior Dimension (W*D*H)	Packing Dimension (W*D*H)	Container load (20'/40'/40'H)	Support Stand	Certification
Clean Bench									
HCB-900V	220/50	≥300	115/145 (kg)	900*530*520 (mm)	970*630*1730 (mm)	1105*745*1280 (mm)	15/33/33	755mm high chassis	CE, TUV SUD Mark, NMPA (CFDA)
			254/319 (lbs)	35.4*20.9*20.5 (in)	38.2*24.8*68.1 (in)	43.5*29.3*50.4 (in)			
HCB-1300V	115/60	≥300	145/171 (kg)	1300*530*520 (mm)	1370*630*1730 (mm)	1505*745*1280 (mm)	10/25/25	755mm high chassis	/
	220/50	≥300	320/376 (lbs)	51.2*20.9*20.5 (in)	53.9*24.8*68.1 (in)	59.3*29.3*50.4 (in)			
HCB-1300V	220/50	≥300	145/171 (kg)	1300*530*520 (mm)	1370*630*1730 (mm)	1505*745*1280 (mm)	10/25/25	755mm high chassis	CE, TUV SUD Mark, NMPA (CFDA)
			320/376 (lbs)	51.2*20.9*20.5 (in)	53.9*24.8*68.1 (in)	59.3*29.3*50.4 (in)			
HCB-900VS	/	≥400	140/166 (kg)	900*510*550 (mm)	970*640*1820 (mm)	1083*772*1467 (mm)	15/33/33	/	/
			308.6/366 (lbs)						
HCB-1300VS	220/50/60	≥600	180/232 (kg)	1300*510*550 (mm)	1370*640*1820 (mm)	1470*810*1290 (mm)	11/22/22	750mm high chassis	NMPA (CFDA)
			397/511.5 (lbs)	51.2*20.1*21.7 (in)	53.9*25.2*71.7 (in)	57.9*31.9*50.8 (in)			
HCB-1600VS	/	≥1000	202/260 (kg)	1600*510*550 (mm)	1670*640*1820 (mm)	1760*810*1285 (mm)	7/14/14	/	/
			445.3/573 (lbs)						
HCB-1600H	220/50/60	≥1000	165/214 (kg)	1710*550*750 (mm)	1780*790*1960 (mm)	1865*940*1370 (mm)	6/12/12	765mm high chassis	CE, TUV SUD Mark, NMPA (CFDA)
			363.7*471 (lbs)	67.3*21.7*29.5 (in)	70.1*31.1*77.2 (in)	73.4*37.0*53.9 (in)			
HGYX-Y100	220	/	12/15 (kg)	/	300*300*350 (mm)	410*405*495 (mm)	/	/	/

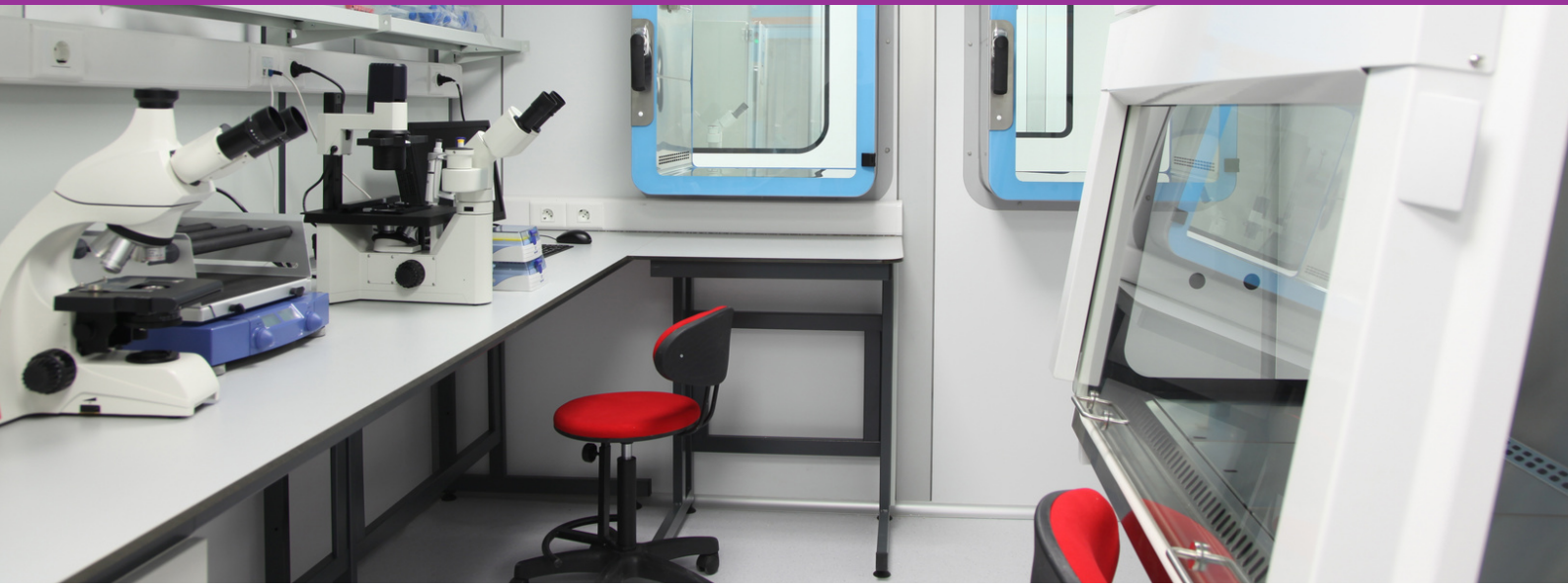

Want to know more?

If you have questions about this item, please give us a call on 01257 270 433.

Richmond Scientific are a family run business in Lancashire. We're a small team, and we're always just a phone call away. With over 30 years in the business there's not much we haven't seen before, and we're always happy to chat.

Have kit to sell?

Call us on 01257 270 433

Email: harry@richmondscientific.com

Visit: www.richmondscientific.com

[Visit Website](#)

[Sell used kit](#)

[Our newsletter](#)