

# Agilent Graphite Tube Atomizer GTA 120 (Including GTA Viewing and Fume Extraction Apparatus)

## User's Guide



# Notices

## Manual Part Number

8510118500

Edition 11, December 2021

## Copyright

© Agilent Technologies, Inc. 2021

No part of this manual may be reproduced in any form or by any means (including electronic storage and retrieval or translation into a foreign language) without prior agreement and written consent from Agilent Technologies, Inc. as governed by United States and international copyright laws.

Agilent Technologies, Australia (M) Pty Ltd  
679 Springvale Road  
Mulgrave, Victoria, 3170  
Australia  
www.agilent.com

## Instrument Manufacturing

Manufactured by Agilent Technologies  
Agilent Technologies LDA Sdn Bhd  
Bayan Lepas Free Industrial Zone  
11900 Penang, Malaysia

Printed in Malaysia

## Warranty

The material contained in this document is provided “as is,” and is subject to being changed, without notice, in future editions. Further, to the maximum extent permitted by applicable law, Agilent disclaims all warranties, either express or implied, with regard to this manual and any information contained herein, including but not limited to the implied warranties of merchantability and fitness for a particular purpose. Agilent shall not be liable for errors or for incidental or consequential damages in connection with the furnishing, use, or performance of this document or of any information contained herein. Should Agilent and the user have a separate written agreement with warranty terms covering the material in this document that conflict with these terms, the warranty terms in the separate agreement shall control.

## Technology Licenses

The hardware and/or software described in this document are furnished under a license and may be used or copied only in accordance with the terms of such license.

## Restricted Rights Legend

U.S. Government Restricted Rights. Software and technical data rights granted to the federal government include only those rights customarily provided to end user customers. Agilent provides this customary commercial license in Software and technical data pursuant to FAR 12.211 (Technical Data) and 12.212 (Computer Software) and, for the Department of Defense, DFARS 252.227-7015 (Technical Data - Commercial Items) and DFARS 227.7202-3 (Rights in Commercial Computer Software or Computer Software Documentation).

## Safety Notices

### CAUTION

A **CAUTION** notice denotes a hazard. It calls attention to an operating procedure, practice, or the like that, if not correctly performed or adhered to, could result in damage to the product or loss of important data. Do not proceed beyond a **CAUTION** notice until the indicated conditions are fully understood and met.

### WARNING

A **WARNING** notice denotes a hazard. It calls attention to an operating procedure, practice, or the like that, if not correctly performed or adhered to, could result in personal injury or death. Do not proceed beyond a **WARNING** notice until the indicated conditions are fully understood and met.

# Contents

<b>1</b>	<b>Safety Practices and Hazards</b>	<b>7</b>
	General	7
	Verifying Safe State	8
	Warning Symbols	9
	Notes	11
	Color Coding	11
	Electrical Hazards	11
	Compressed Gas Hazards	12
	Chemical Hazards	13
	Other	13
<b>2</b>	<b>Introduction</b>	<b>15</b>
	Working Environment	15
	Specifications	16
	Environmental Conditions	16
	Power	16
	Gas Supplies	17
	Water Supply	17
	Weights and Dimensions	18
<b>3</b>	<b>Getting Started</b>	<b>19</b>
	GTA Control Unit	19
	Front View	19
	Back View	21
	GTA Furnace	21
	Water Supplies	21

## Contents

Gas Supplies	22
<b>4 Using Your GTA</b>	<b>25</b>
Installation	25
Moving the Accessory	25
Installing the Control Unit	26
Installing the Furnace	26
Non-Zeeman GTA	26
Zeeman GTA	27
Setting the Gas Supply	29
Turning on the Water Supply	29
Installing the Tube-CAM Camera Option – Agilent 240/280 AA Only	30
Installing the Mirror	30
The Optional GTA Viewing/Fume Extraction Accessory	31
Installing the Programmable Sample Dispenser (PSD)	31
Graphite Tubes and Platforms	31
Types of Available Graphite Tubes	31
Types of Available Graphite Platforms	32
Inserting a Graphite Tube	33
Removing a Graphite Tube	34
Removing Your GTA Furnace	34
<b>5 The GTA Viewing/Fume Extraction Accessory (Optional)</b>	<b>37</b>
Requirements for Fume Extraction	38
Installing the GTA Viewing/Fume Extraction Accessory	39
Installing the GTA Viewing/Fume Extraction Accessory to the Instrument	39
Installing the Extraction System to the Laboratory Exhaust System	41

## Contents

Operation and Maintenance	43
<b>6 Maintenance</b>	<b>47</b>
General	47
Graphite Shroud and Electrodes	47
Hoses and Connections	48
Cleaning the Quartz Windows	48
Removing and Replacing Electrodes	48
Non-Zeeman Electrode Removal	49
Non-Zeeman Electrode Replacement	52
Zeeman Electrode Removal	53
Zeeman Electrode Replacement	55
Fuses	56

## Contents

This page is intentionally left blank.

# 1 Safety Practices and Hazards

General	7
Verifying Safe State	8
Warning Symbols	9
Notes	11
Color Coding	11
Electrical Hazards	11
Compressed Gas Hazards	12
Chemical Hazards	13
Other	13

## General

A Graphite Tube Atomizer, used in conjunction with an Atomic Absorption spectrometer, uses compressed inert gases and high voltages. The system generates radiant energy and hazardous wastes including corrosive fluids and flammable liquids.

Careless, improper or unskilled use of this system can cause death or serious injury to personnel, or severe damage to equipment and property.

All users of an AA (Atomic Absorption) and GTA (Graphite Tube Atomizer) instrument must be familiar with the correct operating procedures. Appropriate safety practices have been included in this operation manual and your spectrometer operation manual, to help you operate the equipment safely. Read **all** safety practices thoroughly before attempting to operate your system.

The covers on instruments and accessories must not be removed by the operator, except as permitted for the routine maintenance tasks detailed in the relevant operation manuals.

Service is to be performed only by Agilent field support engineers.

The safety practices described below are provided to help you operate your instrument safely. Read these safety practices thoroughly before attempting to operate the instrument and always operate the spectrometer in accordance with these safety practices.

The GTA uses interlocks and covers which are designed to prevent accidental contact with any of the potential hazards. It is good practice, however, to develop

## Safety Practices and Hazards

safe working habits which do not depend upon the correct operation of the interlocks for safe operation. It is essential that no interlock or cover is bypassed, damaged or removed.

Fumes generated by the GTA can be hazardous, and **must** be extracted by an exhaust system. Ensure that an exhaust of the appropriate type is fitted, as specified in the pre-installation instructions. It must be vented to the outside air, never within the building. Regularly check the exhaust system by smoke test to ensure that it is functioning correctly. Always switch the exhaust fan on before operating the instrument.

### WARNING



#### Noxious Gas

**An exhaust system must be used with an Agilent AA flame and furnace instruments to remove hazardous and toxic gases.**

---

If the equipment is used in a manner not specified by the manufacturer, the protection provided by the equipment may be impaired.

## Verifying Safe State

The following general safety precautions must be observed during all phases of operation, maintenance and service of this instrument.

To ensure continued safety of the instrument after maintenance or service procedures verify the instrument is returned to a safe state for the user. This includes running performance checks to verify the instruments safety systems are functioning correctly. Check the general condition of the instrument during operation for wear or signs of corrosion that are likely to inhibit function or safety.

Failure to comply with these precautions or with specific warnings elsewhere in this manual violates safety standards of design, manufacture, and intended use of the instrument. Agilent Technologies assumes no liability for the customer's failure to comply with these requirements.



### Warning Symbols

The following is a list of symbols that appear in this manual in conjunction with warnings on the instrument. The hazard they describe is also shown.

A triangular symbol indicates a warning. The meanings of the symbols that may appear alongside warnings in the documentation or on the instrument itself are as follows:



*Corrosive liquid*



*Electrical shock*



*Explosion hazard*



*Eye hazard*



*Fire hazard*



*Heavy weight  
(danger to feet)*



*Heavy weight  
(danger to hands)*



*Hot surface*



*Magnetic hazard*



*Moving parts*



*Noxious gas*









*Toxic hazard*

The following symbol may be used on warning labels attached to the instrument. When you see this symbol, refer to the relevant operation or service manual for the correct procedure referred to by that warning label.



## Safety Practices and Hazards

The following symbols appear on the instrument for your information.

I	Mains power on
0	Mains power off
	Fuse
	Single phase alternating current
	Disconnect all power plugs
	Inlet gas
	Inlet for cooling liquid
	Outlet for cooling liquid

### WARNING



#### Explosion Hazard

Pure H<sub>2</sub> must NOT be used in this product.

N<sub>2</sub> or Ar containing ≤5%v/v H<sub>2</sub> CAN be used in the Alternate gas port.

L'hydrogène pur ne doit pas être utilisé dans ce produit.

De l'azote ou de l'argon contenant 5 %v/v d'hydrogène ou moins PEUT être utilisé avec l'entrée de gaz alternative.

### Notes

A Note is used to give advice or information. The format of a Note is as follows:

NOTE

Note text appears here.

---

### Color Coding

The various indicator lights appearing on the accessory has been color coded to represent the status of the accessory:

- A green light indicates the instrument is in normal/standby condition.
- An orange light indicates that a potential hazard is present.
- A blue light indicates that operator intervention is required.
- A red light warns of danger or an emergency.

### Electrical Hazards

The GTA electronic control module contains electrical circuits, devices and components operating at dangerous voltages. Contact with these circuits, devices and components can cause death, serious injury or painful electric shock. Panels or covers that are retained by screws on the GTA may **only** be opened by Agilent field service engineers.

Use of the wrong supply voltage, connection of the accessory to an incorrectly wired supply outlet, or lack of proper electrical grounding can create a fire or shock hazard that can cause death, serious injury, or serious damage to equipment.

- 1 Always use a 3-wire outlet with a ground connection that is adequately rated for the load.
- 2 The installation must comply with local, state and national safety regulations.
- 3 Before connecting the GTA, make sure the voltage selector is correctly set for the mains supply to which you are going to connect the accessory. If not you should contact an Agilent field service engineer.

## Safety Practices and Hazards

A blown fuse should be replaced with one of the size and rating stipulated in the text adjacent to the fuse holder. Always ensure the accessory is turned off and disconnected from the mains supply before attempting any replacement.

### WARNING



#### Electrical Shock

**Never attempt to override or disable interlocks. Failure to observe this warning can result in death or serious injury.**

**You must always disconnect the mains power inputs when direct access to the electronics is needed.**

---

### WARNING



#### Magnetic Hazard

**The Zeeman magnet generates a variable magnetic field of 0.8 Tesla (at mains frequency) in the workhead. Pacemakers and magnetic storage media must be kept at least 300 mm from the magnet.**

---

## Compressed Gas Hazards

All compressed gases other than air can create a hazard if they leak into the atmosphere. Even small leaks in gas supply systems can be dangerous. Any leak other than air can result in an oxygen-deficient atmosphere which can cause asphyxiation or anesthesia.

Gas cylinders must be stored and handled strictly in accordance with local safety codes and regulations. Cylinders must be used and stored only in a vertical position and secured to an immovable structure or a properly constructed cylinder stand. Move cylinders only on a properly constructed trolley. The area in which cylinders are stored and the area surrounding the instrument must be adequately ventilated to prevent accumulations of gas.

Use only approved regulator and hose connectors; refer to the gas supplier's instructions. Keep gas cylinders cool and properly labeled, all cylinders are fitted with a pressure relief device which will rupture and empty the cylinder if the internal pressure rises above the safe limit.

Use only 'Instrument Grade' gases with the spectrometer. Ensure that you have the right cylinder before connecting it to the instrument.

## Safety Practices and Hazards

Always ensure that the gas supplies are turned off at the cylinders or tanks after completing an analytical procedure and at the end of the working day. Shut off valves should be installed and easily accessible.

## Chemical Hazards

The GTA accessory may involve the use of materials which are toxic, highly corrosive or otherwise hazardous. Careless, improper, or unskilled use of such materials can cause serious personal injury.

Always ensure that laboratory safety practices governing the use, handling and disposal of such materials are strictly observed. These safety practices should include the wearing of appropriate safety clothing.

Before attempting any work on the sample compartment area, you must know exactly what matrix of solutions has been running through the instrument and particularly what types of solvents are involved.

Always check that the Programmable Sample Dispenser (PSD) has been thoroughly flushed out with distilled water and that the contents of the drain or waste container are known and properly disposed of if necessary before touching any part.

Wash your hands and gloves thoroughly during the course of sample compartment work. Avoid contact between hands and eyes at all times during servicing of the instrument.

## Other

GTA control units are heavy. To avoid injury, or damage to the control unit, two people are needed to move the instrument to the bench location.

Cooling air flow to the spectrometer and the GTA must be unobstructed. Do not block the ventilation grills.

Do not position the equipment so that it is difficult to operate the disconnecting device.

## Safety Practices and Hazards

This page is intentionally left blank.

## 2 Introduction

Working Environment	15
Specifications	16

This manual describes how to install and operate a Graphite Tube Atomizer (GTA) and Zeeman GTA with Agilent AA spectrometers. Your GTA consists of a control unit and a furnace. This manual describes how to install and disconnect the control unit, along with how to install, remove and maintain the furnace for optimum performance.

### NOTE

The GTA 120 is compatible with the Agilent 200 Series AA (including the 140 AA) ONLY.

More information on the operation of your GTA can be found in the comprehensive reference supplied with your GTA – 'Analytical Methods for Graphite Tube Atomizers'.

## Working Environment

Graphite tube atomization is a microanalytical technique which demands a particularly high standard of care in all activities to ensure good precision and accuracy of the analytical result. Strict cleanliness is essential in all laboratory procedures – contamination must be avoided. Ideally, your laboratory should be air-conditioned and draught-free. All sample preparation should be carried out in an area which is well separated from the instrument.

# Specifications

## Environmental Conditions

Your accessory is designed for indoor use only. It is suitable for the following categories:

- Installation category II
- Pollution degree 2
- Equipment class I

Condition	Altitude	Temp (°C)	Humidity (%RH) non-condensing
Non-operating (storage)	0-2133 m (0-7000')	5-45	20-80
Operating within performance specifications	0-853 m (0-2800')	10-35	8-80
	853-2133 m (2800-7000')	10-25	8-80

## Power

- Voltage 208, 220, 230, or 240 VAC
- Frequency 50-60 Hz
- Normal standby consumption 15 A

## Surge current (Courant de surcharge)

Rated firing consumption 40 A

### NOTE

The GTA will draw surge currents in excess of the nominal rating of 15 A (3500 VA). Surges in the GTA accessory depend on the choice of ramp rate and programmed temperature and may be up to 40 A for approximately 1 second, reducing to about 20 A for up to 10 seconds, perhaps repeating every 1 to 2 minutes.

## Electrical Connections

Mains power cord connector:

- Australia: Clipsal 439D15M
- USA: Complies with NEMA 6-30P (Hubbel#9331)
- Europe: Kaiser CEBEC 616 VDE (complies with DIN 49441R2)

### NOTE

The GTA 120 has a captive cable.



## Introduction

IEEE-488 is at the rear of the instrument.

Zeeman furnace: CPC 14-way connection into the left hand side panel of a Zeeman spectrometer (behind the exterior panel).

## Gas Supplies

An inert gas is always needed at the 'Normal' gas inlet to the GTA. This gas is used to shroud the hot graphite components and prevent oxidation.

The preferred gas for the 'Normal' gas inlet is argon. Nitrogen is an acceptable lower cost alternative but furnace performance may be degraded for some elements and tube lifetime may be reduced. The argon or nitrogen used must be at least 99.99% pure.

Nitrogen or air may be used at the 'Alternate' gas inlet. A choice is made on the basis of the analytical technique for the sample.

### NOTE

Recommendations are made in the document 'Analytical Methods for Graphite Tube Atomizers'.

---

Gas supplies must be regulated to maintain the instrument operating pressure under dynamic conditions.

The gas must be dry and dust-free; otherwise you must insert a suitable filter in the supply line.

Recommended pressure: 140 kPa (20 psi)

Maximum pressure: 350 kPa (50 psi)

Normal flow rate approx 0–3.5 L/min

Normal gas connection is 6 mm (1/4 in.) barb.

Alternate gas connection is 6 mm (1/4 in.) barb.

Snap-on gas connector for PSD accessory inside power supply panel.

## Water Supply

Maximum temperature 40 °C (104 °F)

Recommended temp. range 18–25 °C (64–70 °F)

### NOTE

Water temperature should be set above the dew point to avoid condensation forming on the workhead surfaces.

---

## Introduction

**Minimum flow rate required** 1.5 L/min at 180 kPa (27 psi)

**Typical flow rate at recommended pressure range** 1.5–2.0 L/min

Typically removes 950 W of heat at 20 °C.

Water connections are 6 mm (1/4 in.) barb, inlet and outlet.

## Weights and Dimensions

### GTA 120 (Deuterium)

#### Weight

Net 37 kg (82 lb)

Shipping 72 kg (159 lb)

#### Dimensions (W x D x H)

Control unit 240 x 570 x 580 mm (10 x 22 x 23 in)

Furnace 150 x 150 x 340 mm (6 x 6 x 13 in)

Packed 950 x 760 x 900 mm (37 x 30 x 35 in) [includes PSD]

### GTA 120 Zeeman

#### Weight

Net 48 kg (106 lb)

Shipping 83 kg (183 lb)

#### Dimensions (W x D x H)

Control unit 240 x 570 x 580 mm (10 x 22 x 23 in)

Zeeman 220 x 290 x 340 mm (9 x 11 x 13 in)

Packed 950 x 760 x 900 mm (37 x 30 x 35 in) [includes PSD]

The length of the connection between the control unit and the furnace (the umbilical cord) is 380 mm (15 in.).

Locate the PC keyboard and mouse for ergonomically correct access.

## 3 Getting Started

GTA Control Unit	19
GTA Furnace	21
Water Supplies	21
Gas Supplies	22

Your GTA consists of a control unit and a furnace, permanently connected to each other by a flexible umbilical tube. This tube contains the water and gas supplies as well as the power and control cable for your GTA furnace. For Zeeman instruments, the furnace is also connected to the instrument by a cable that plugs into the main instrument.

For non-Zeeman spectrometers, the GTA furnace is installed in the sample compartment of your instrument when operating in furnace mode. When operating in flame mode, you must remove the furnace from the sample compartment and place it in the storage location inside the control unit. For Zeeman spectrometers, the furnace can remain in the sample compartment at all times.

The GTA uses the PSD (Programmable Sample Dispenser) to automatically deliver measured volumes of sample to the furnace.

### GTA Control Unit

The GTA control unit controls the furnace by regulating the temperature and controlling the gas supply in accordance with the parameters set in the current software method. Similarly, the unit also controls the Programmable Sample Dispenser (PSD).

#### Front View

On the front panel of your GTA control unit are the power switch and the 'power on' indicator. The inert gas supply for the Programmable Sample Dispenser (PSD) and the PSD control socket are located in the power supply compartment. (The power supply compartment door must be opened to access these).

## Getting Started

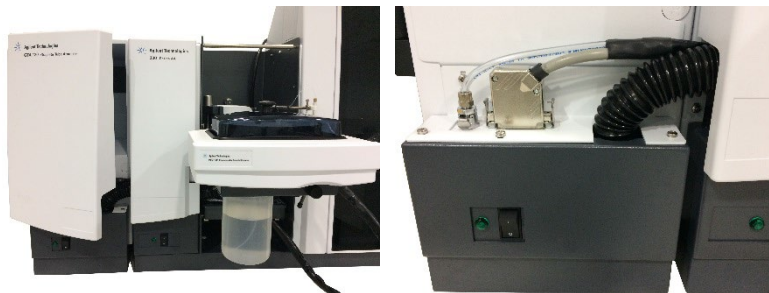

**Figure 1.** The 'power on' indicator and power switch (right, bottom center of the photo) and the power supply compartment door being opened (left).

### Power Switch and Indicator

The power switch and indicator are on the front of the control unit. The indicator lights up when the GTA is on.

The power switch is a rocker type on-off circuit breaker for the mains power supply, which also provides over-current protection.

#### NOTE

If the atomizer is held at high temperatures (2800 °C) for long periods of time (20 seconds) the circuit breaker may trip.

If the circuit breaker trips open during normal operation, this indicates an over-current fault condition. Wait for at least 20 seconds before attempting to close the circuit breaker again. If the circuit breaker will not remain closed, call your Agilent field service engineer.

### Programmable Sample Dispenser Connections

The Programmable Sample Dispenser (PSD) is used with the GTA to dispense solutions into the furnace. The inert gas supply connector and control plug connector for the PSD are located in the power supply compartment. See Figure 1 above.

The gas supply connector is a quick-connect automatic seal-off type connector. This provides inert gas to pressurize the sampler rinse system.

The control connector is a 25-way 'D' connector, which provides drive and control signals for the PSD and power for the dispenser actuator system.

For more details about the PSD and its installation refer to the PSD User's Guide.

## Getting Started

### Back View

The back of the GTA control unit contains the appropriate inlets for the power, water and gas supplies. A communications cable connects the GTA to the computer IEEE card via the spectrometer.

The GTA will be set up, ready for use by a field service engineer during installation. However, you can also refer to sections on the Pages 21 and 22 for more information on the water and gas supplies.



**Figure 2.** Back of the GTA 120 control unit

### GTA Furnace

The GTA furnace consists of an electrically heated graphite tube located in a chamber with windows at each end. A toggle lever at the front left allows you to open one end of the furnace to insert or remove graphite tubes.

### Water Supplies

During installation of your GTA, the Agilent field service engineer will connect the water supply. The water pressure is set in accordance with the specifications listed in Section 2.

## Getting Started

A continuous supply of cooling water must be provided for the GTA furnace. If there is insufficient water (for example, not enough pressure, failure of the supply, the supply is turned off), an interlock will prevent the atomizer system from operating. A fault message will be displayed on the screen and a beeper will sound. The water supply must be restored before the GTA can be restarted.

An automatic cutout will stop operation if the water temperature exceeds the maximum temperature as specified in the 'Water Supply' section on Page 17.

---

**NOTE**

Ensure that the return path is not blocked or switched off.

---

## Gas Supplies

Two gas inlets are provided, 'Normal' and 'Alternate'. The supply of gas to the GTA is set up and regulated during installation by an Agilent field service engineer.

---

**NOTE**

Depending on your requirements at the time, the alternate gas supply may not have been connected at installation. If you need to add this supply later, connect a gas supply to the alternate gas inlet, regulated as per the specifications provided in Section 2.

---

The gas pressure is set at installation in accordance with the specifications included in Section 2.

You should be aware of the following points:

- Inert gas must be supplied through the 'Normal' inlet at the back of the control unit; otherwise the system will not operate. If the gas supply is turned off or fails, a monitoring system will cause the system to stop. Both normal and alternate supplies are monitored. A supply failure in a gas needed by your method will cause the system to stop, an error message to be displayed on the screen and the beeper to sound.
- As outlined in Section 2, the gas supplied through the 'Normal' inlet must be an inert gas (either nitrogen or argon) but you can use either an inert gas or other gases as the alternate gas.

An alternate gas may be used for many reasons. For example, it can reduce background interferences. Refer to the SpectrAA Help or 'Analytical Methods for Graphite Tube Atomizers' for more information on the use of alternate gases.

## Getting Started

### NOTE

Although more expensive, argon will generally give better analytical sensitivity and longer tube life than nitrogen during the 'Read' stage. However it is possible to use nitrogen during the drying/ashing stages and argon during the ashing/atomization stage. This will reduce gas use costs.

If you are not using an alternate gas, you should cover the inlet to protect against dust, moisture etc. If you use air, make sure that your furnace method is in accordance with the limitations on the use of air.

---

### NOTE

If air ashing is employed, the flow should be high enough to remove ashing products and generally assist the ashing process. Do not use air at graphite tube temperatures above 250 °C, as this will cause excessive deterioration of the graphite furnace tube.

---

All gases must be clean, dry and of high purity.

### WARNING

#### Fire and Explosion Hazard

To avoid a fire or explosion which could result in death or serious personal injury, burns or property damage, **NEVER** use pure hydrogen (or any gas with a hydrogen content greater than 5%) in the GTA. You may use a proprietary, pre-packaged mixture of 95% argon and 5% hydrogen as an alternate gas.



## Getting Started

This page is intentionally left blank.



## 4 Using Your GTA

Installation	25
Moving the Accessory	25
Installing the Control Unit	26
Installing the Furnace	26
Setting the Gas Supply	29
Turning on the Water Supply	29
Installing the Tube-CAM Camera Option – Agilent 240/280 AA Only	30
Installing the Mirror	30
The Optional GTA Viewing/Fume Extraction Accessory	31
Installing the Programmable Sample Dispenser (PSD)	31
Graphite Tubes and Platforms	31
Removing Your GTA Furnace	34

### Installation

Before proceeding, you should have:

- Read the Safety section in this manual and your instrument User's Guide
- Set up the AA instrument

### Moving the Accessory

#### WARNING



#### Heavy Weight – Danger to Hands and Feet

When packed, the GTA weighs up to 87 kg (192 lb). To avoid injury to personnel, or accidental damage to equipment, do not attempt to lift the package alone.

# Installing the Control Unit

The control unit should have already been set up by an Agilent Field Service Representative. If you wish to move the GTA you will need to disconnect the control unit's mains power cable, gas hose(s) and water hoses from their respective supplies.

To install the control unit you must:

- Plug the mains power cable into the mains power supply.
- Connect the gas and water supplies as described in the previous chapter.

# Installing the Furnace

## Non-Zeeman GTA

Before installation, the GTA 120 furnace will be kept in the storage location on the control unit.

**To remove the GTA 120 furnace from its storage cradle and install it in the sample compartment:**

- 1 Ensure that both the spectrometer and GTA control unit are switched off and that the spraychamber, etc. have been removed and safely stowed.
- 2 Remove the instrument left panel, and remove the cut-out fill plate, if applicable. To do this, lift the bottom of the panel upward and then pull it forward (see Figure 4).
- 3 Undo the retaining screw (see Figure 3), then remove the GTA workhead from its storage position in the power supply compartment.

## Using Your GTA

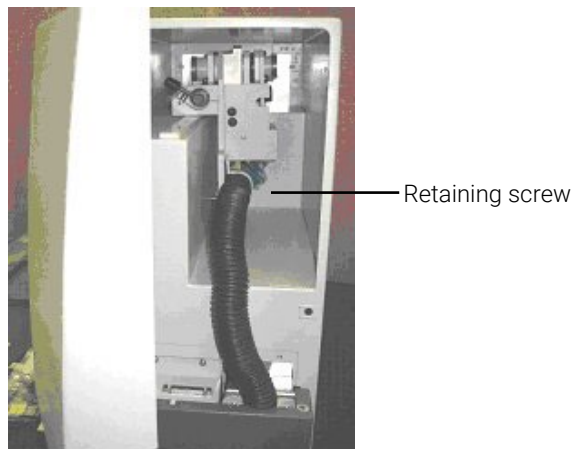

**Figure 3.** Location of the retaining screw

- 4 Look under the furnace and note the position of two spigots (near the toggle lever). These will fit into the two holes on the top of the burner adjuster on the left side of the sample compartment. Similarly, note the presence of one stainless steel spigot near the base of the furnace. When you install the furnace, this will be inserted into a slot in the burner adjuster.
- 5 Tilt the furnace slightly to the left and engage the two spigots in the top of the burner adjuster. Then insert the metal spigot into the slot.
- 6 Tighten the securing screw on the bottom right-hand side of the furnace so that the furnace is firmly secured to the mounting block.

### NOTE

The umbilical should be recessed behind the front panel of the instrument. (The front panel has a cutout in it to accommodate this.)

- 7 Align the furnace. Refer to the SpectrAA Help for details on how to do this.
- 8 Replace the instrument left panel.

### NOTE

For instruction about how to install and adjust the Programmable Sample Dispenser (PSD) refer to the PSD User's Guide.

## Zeeman GTA

The furnace will have been installed by an Agilent field service engineer during installation of the instrument. However, if you have removed the furnace to replace the electrodes or clean the sample compartment, reinstall the furnace workhead as follows:

## Using Your GTA

- 1 Ensure that both the spectrometer and GTA control unit are switched off.
- 2 Remove the left panel on the instrument. To do this, lift the bottom of the panel upward and then pull it forward (see Figure 4).

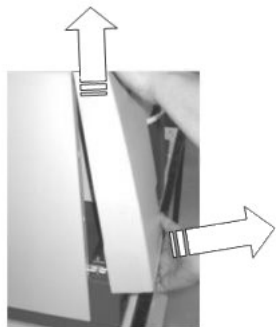

**Figure 4.** Removing the left panel on the instrument

- 3 Lift the furnace towards the sample compartment, ensuring the umbilical cord is not twisted as you do so.
- 4 Keeping the power cord out of the way, lower the workhead onto the rollers, with the slots over the rollers.
- 5 Ensuring the furnace is correctly installed; carefully pull the top of the workhead towards you. It should tilt about 30° then rest on the stops.
- 6 Plug the furnace power cable plug into the socket located on the rear wall of the compartment exposed when the left panel was removed (see Figure 5).



**Figure 5.** Power cable plugged into connector on the 280Z AA

### NOTE

Rotate the plug to match the pins in the socket and then push the plug in. Screw the collar up finger tight until it locks into position.

## Using Your GTA

### CAUTION

Ensure the plug is securely in place. A loose plug will lead to arcing between the pins of the plug and damage to the electrical system of the instrument.

---

- 7 Refit the left hand panel.
- 8 Align the HC lamps. Refer to the SpectrAA Help for instructions.
- 9 Carefully tilt the workhead back into the sample compartment.
- 10 Align the vertical furnace position.

## Setting the Gas Supply

Turn on the gas supplies at the cylinders and set the regulators as detailed in the 'Specifications' section on Page 16.

### CAUTION

The use of pressures above the recommended maximum may burst internal gas hoses, requiring service replacement.

---

## Turning on the Water Supply

If you are using a recirculating system, you should refer to its operating instructions.

### NOTE

Refer to the required water pressures listed in the 'Water Supply' section on Page 17.

---

If you are using a mains water supply, turn it on. The water pressure regulator was set at the factory as per the specifications included in Section 2.

### CAUTION

The use of higher pressures may burst water hoses within the furnace assembly, requiring service replacement.

---

After turning on your supply, you should check all hoses and connections for leaks. If you find any you should contact your Agilent field service engineer.

## Installing the Tube-CAM Camera Option – Agilent 240/280 AA Only

This optional accessory allows you to view images from inside the graphite tube on your PC so you can monitor sample drying during method development and accurately set the probe dispensing height during alignment.

If you have purchased the camera accessory option, the camera will be installed in your instrument at the factory. Camera drivers are supplied on a CD-ROM. To install the camera drivers, follow the instructions on the Installation sheet shipped with the instrument.

## Installing the Mirror

You may have ordered a mirror to allow you to view the inside of the graphite tube in the GTA furnace. This may help in method development (observing the dry phase) and in setting the PSD capillary position.

**To install this mirror:**

- 1 Remove the chimney.
- 2 Clip the mirror mounting block over the bar at the front of the sample compartment, on the left-hand side.
- 3 Tighten the securing screw.

The mirror can be rotated and moved up or down the shaft. When you want to use the mirror, swing the mirror lever so that the mirror is in front of the atomizer window, and adjust the height and angle of the mirror so that you can view the inside of the graphite tube atomizer.

**WARNING**

**Eye Hazard**

**To avoid eye damage DO NOT look at a glowing furnace.**



## The Optional GTA Viewing/Fume Extraction Accessory

If you are using the GTA viewing/fume extraction accessory, you should install it now. Refer to Section 5 for installation instructions.

## Installing the Programmable Sample Dispenser (PSD)

To install the PSD, follow the instructions in your PSD User's Guide.

## Graphite Tubes and Platforms

After setting up your GTA (and PSD), you can insert a graphite tube and start your analytical run according to your instrument operation manual. This section describes the types of tubes and platforms available and how to install and remove them.



**WARNING**



**Hot Surface**

Parts of the furnace become very hot during use. To prevent burns, ALWAYS allow the furnace to cool before touching.

### Types of Available Graphite Tubes

Description	Part number	Picture
Omega platform tube, pyrolytically coated (Packet of 10)	6310003700	
Partitioned tube, pyrolytically coated (Packet of 10)	6310001200	
Plateau, pyrolytically coated (Packet of 10) required for use with pyrolytic graphite platforms	6310001100	

### Types of Available Graphite Platforms

Description	Part number	Picture
Platforms, solid pyrolytic graphite (Packet of 10) for use with plateau tubes only	6310001300	

#### 'Forked' Platforms

These platforms are inserted into grooves in a notched partitioned tube.

The instructions for inserting a forked platform into the furnace are contained in its instruction booklet.

#### Normal Platforms

For normal platforms in plateau tubes, first insert the platform so that it is horizontal to, and centered around the injection hole. Then place the tube into the graphite shroud following Steps 3 and 4 in the 'Inserting a Graphite Tube' section starting on Page 33.

You will now need to re-check that the platform is still horizontal to the injection hole. Because the mirror is angled when used to view the graphite tube, you must use a capillary or pipette tip to determine if the platform is horizontal. Insert the pipette tip and, with the mirror, check that the platform is perpendicular to the tip.

#### NOTE

If you are using the Tube-CAM to align the platform, you will still need to check the vertical alignment since the camera may not be completely level.

Alternatively, you can attach and start the sample dispenser and check that the sampler dispensing capillary is perpendicular to the platform. Refer to your PSD operation manual.

#### NOTE

Normal platforms cannot be used with partitioned tubes.

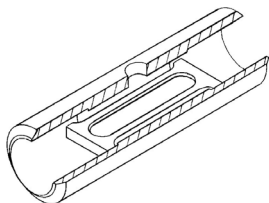

**Figure 6.** Correct positioning of a graphite platform inside a plateau tube

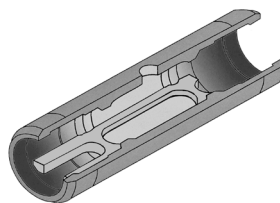

**Figure 7.** Correct positioning of a forked platform inside a notched tube



## Using Your GTA

### Inserting a Graphite Tube

To insert a graphite tube:

- 1 If you are using a Zeeman graphite furnace, tilt the furnace assembly forward to access the top of the furnace.

**NOTE**

Some operators may find it easier to tilt the furnace when inserting a graphite tube. However, it is possible to carry out this procedure without tilting the furnace. If you are going to tilt the furnace, the PSD must first be removed.

- 2 Open the furnace and insert the graphite tube into the furnace taking care to ensure the injection hole is on top.

**NOTE**

Handle graphite tubes with care and only in a clean working environment.

**NOTE**

Video clips of how to insert graphite tubes are available in the Agilent SpectrAA Help.

- 3 Place the alignment tool through the hole at the top of the furnace and into the hole in the graphite tube.
- 4 Close the workhead using the accessory lever. This will hold the graphite tube in the correct position.

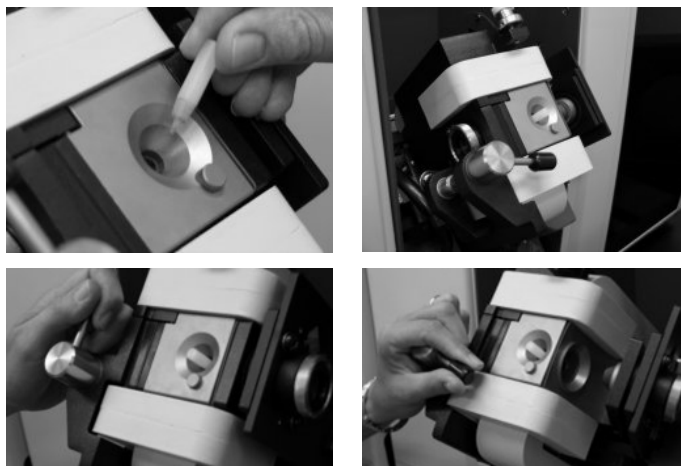

**Figure 8.** Aligning the graphite tube using the alignment tool

- 5 Push the furnace back into position.

## Using Your GTA

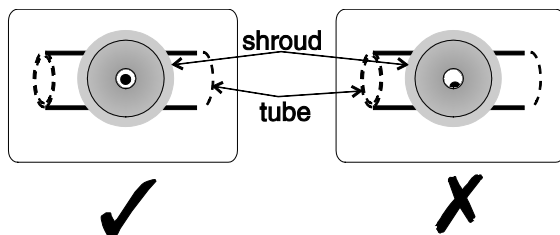

**Figure 9.** Using the tool ensures correct injection hole positioning (top view)

### NOTE

BEFORE using a new graphite tube for analyses, condition the tube by using the condition tube function, accessible from furnace facilities. This will run the current furnace temperature program injecting blank and any modifier solution (if programmed). Conditioning the tube removes any residual contamination from the tube. (The tube clean facility should only be used on already conditioned tubes.)

## Removing a Graphite Tube

### NOTE

Video clips of how to remove graphite tubes are available in the Agilent SpectrAA Help.

### To remove a graphite tube:

- 1 Swing the toggle lever fully to open the furnace.
- 2 Using the extractor tool provided, remove the graphite tube.

## Removing Your GTA Furnace

If you need to remove your GTA from the sample compartment, follow these steps:

### NOTE

Video clips of how to remove GTA furnaces are available in the Agilent SpectrAA Help.

### Non-Zeeman:

- 1 Turn off the gas and water supplies.
- 3 Turn off the GTA control unit.
- 4 Remove the PSD if it is connected (refer to your PSD User's Guide).

## Using Your GTA

- 5 Remove the left-hand panel on the instrument and open the access door on the GTA control unit.
- 6 Loosen the securing screw on the bottom right side of the furnace that secures the furnace to the burner adjuster.
- 7 Lift the furnace away from the mount and out of the sample compartment.
- 8 Swing the furnace toward the storage cradle on the GTA power supply compartment in a wide arc – you should prevent the black umbilical tube from twisting.
- 9 Lower the furnace into position for storage. Fasten the securing screw finger tight.
- 10 Refit the left-hand instrument panel.

### Zeeman

- 1 Turn off the gas and water supplies.
- 2 Turn off the spectrometer and the GTA control unit.
- 3 Remove the PSD if it is connected (refer to your PSD User's Guide).
- 4 Tilt the furnace forward.
- 5 Remove the left-hand panel on the instrument.
- 6 Unscrew the collar on the plug and remove the plug from the socket (280 AA Zeeman only).
- 7 Lift the furnace off the rollers and out of the sample compartment.
- 8 Place the furnace on a stable bench top.

### WARNING



#### Heavy Weight – Danger to Hands and Feet

The furnace workhead is very heavy. Use appropriate lifting techniques when moving the furnace.

Particular care should be taken if the bench or trolley are positioned in front of the instrument.

## Using Your GTA

This page is intentionally left blank.

## 5 The GTA Viewing/Fume Extraction Accessory (Optional)

Requirements for Fume Extraction	38
Installing the GTA Viewing/Fume Extraction Accessory	39

The GTA viewing/fume extraction accessory is an optional addition to your Agilent AA instrument and can be used in conjunction with the mirror or the Tube-CAM to give you further control over the alignment of the graphite tube and PSD.

### NOTE

The GTA viewing/fume extraction accessory is compatible with Agilent 280 AA, 240 AA and 140 AA instruments only.

The GTA viewing/fume extraction accessory has three components:

- A mirror to allow you to view the workhead sample introduction port and simplify the alignment of the dispensing capillary.
- A light to illuminate the workhead for easier viewing of the graphite tube when aligning the PSD or when viewing using the optional Tube-CAM.
- An extraction port which can be connected to the instrument flue, enabling efficient removal of fumes and exhaust gases from the furnace during operation.

The GTA viewing/fume extraction accessory can be used with graphite furnace operation on either a Flame or Zeeman instrument.

### NOTE

It is easier to install the GTA viewing/fume extraction accessory when the PSD is not fitted.

### Requirements for Fume Extraction

Recommended requirements for fume extraction:

- The GTA viewing/fume extraction accessory must be fitted to a suitable duct. The diameter of the duct must be either:
  - 150 mm  $\pm$  2.5 mm (6 in.), or
  - 125 mm  $\pm$  2.5 mm (5 in.).
- The extraction flow rate, without the GTA viewing/fume extraction accessory fitted, must be 6 m<sup>3</sup>/min (200 cfm), as specified in the Agilent AA Site Preparation Guide.
- For correct fume extraction, the flow rate through the GTA viewing/fume extraction accessory must be 0.27 m<sup>3</sup>/min (9.5 cfm). This gives a pressure drop across the device of approximately 0.1 kPa (0.014 psi), when measured between the inside of the extraction duct and the atmosphere, with the GTA viewing/fume extraction accessory fitted to the instrument. Refer to Figure 10. Performance is dependent on the configuration of the fume extraction system and fan characteristics. Contact your Agilent field service engineer if further assistance is required.

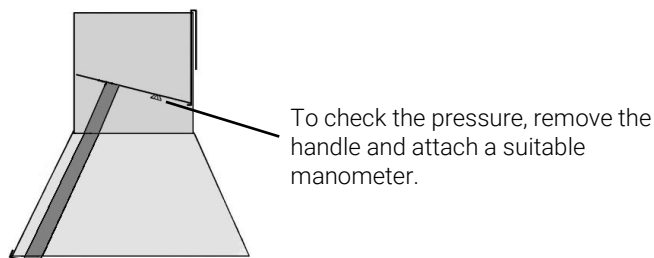

**Figure 10.** Checking the flow rate through the accessory

#### NOTE

You can check that fume extraction is occurring by installing the GTA viewing/fume extraction accessory, then running a sample that produces smoke and checking that all of the smoke is extracted from each firing.

## Installing the GTA Viewing/Fume Extraction Accessory

Installation of the GTA viewing/fume extraction accessory can be divided into two parts: fitting the accessory to the instrument, and connection of the accessory to the instrument flue.



**Figure 11.** The components of the GTA viewing/fume extraction accessory

### Installing the GTA Viewing/Fume Extraction Accessory to the Instrument

- 1 Set the support bracket to the required location for your instrument type. To adjust the bracket, loosen the screws and slide the bracket to the desired position. Refer to Figure 12 and Figure 13.

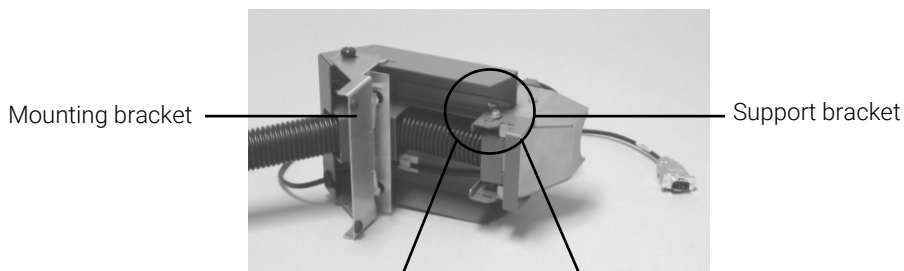

**Figure 12.** The support bracket in the position for Zeeman instruments



**Figure 13.** The support bracket in the position for D<sub>2</sub> instruments

## The GTA Viewing/Fume Extraction Accessory (Optional)

- 2 Set the mounting bracket to the highest position and gently tighten the screws.
- 3 Clip the accessory onto the flame shield. Make sure that the edge of the flame shield fits between the spring canoe-clips. Refer to Figure 14, Figure 15 and Figure 16.

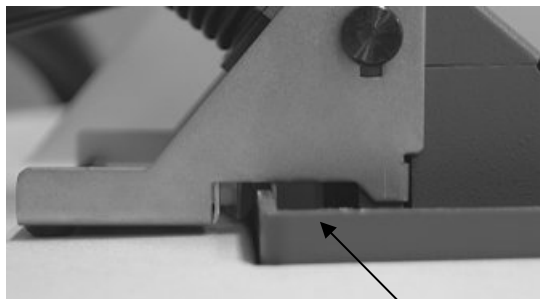

Edge of flame shield

**Figure 14.** The GTA viewing/fume extraction accessory clips onto the flame shield and is secured by spring-clips.

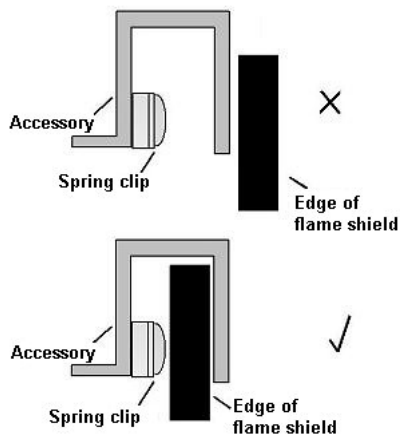

**Figure 15.** Note the correct location of the edge of the flame shield in relation to the spring clip on the accessory

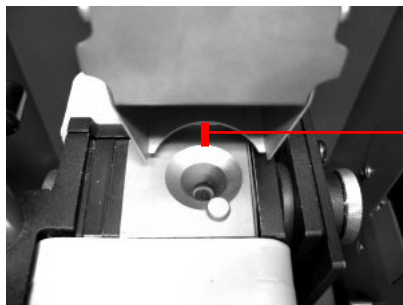

**Figure 16.** The canoe-clips hold the accessory in place firmly against the flame shield



## The GTA Viewing/Fume Extraction Accessory (Optional)

- 4 The base of the accessory should sit 2–3 mm above the magnet/workhead. Loosen the mounting bracket screws and set the accessory to the correct height. Tighten the screw firmly.
- 5 Check that the accessory is firmly in place and cannot move from side to side. The curve at the bottom of the accessory should be centered over the sample port. Refer to Figure 17.



Leave a 2–3 mm gap between the furnace and the rim of the accessory.

**Figure 17.** The rim of the accessory should be centered over the sample port

### NOTE

To adjust the position of the accessory, tilt the base forwards and lift it up slightly to enable the accessory to move freely. Move the accessory to the desired position and then press it down to lock into place.

- 6 Plug the accessory into the accessory port on the instrument using the 9 way D-type connector fitted to the accessory. The accessory port is located on the rear right hand side of the instrument.

## Installing the Extraction System to the Laboratory Exhaust System

The GTA viewing/fume extraction accessory is connected to the extraction duct using an adaptor plate. Two plates are supplied with the accessory: use the longer one if you have a 150 mm (5 in.) duct and the smaller one if you have a 125 mm (5 in.) duct. If your duct is a different size, contact your local Agilent field service engineer.

## The GTA Viewing/Fume Extraction Accessory (Optional)

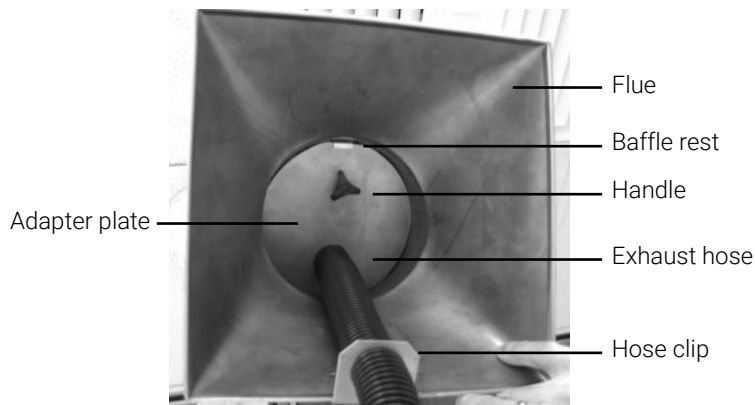
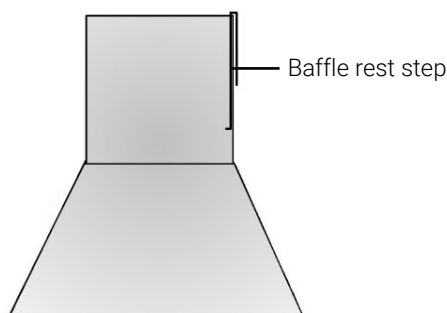

**Figure 18.** The GTA viewing/fume extraction accessory fits into the flue of the instrument exhaust system

### NOTE

It may be easier to disconnect the exhaust hose from the accessory first. Refer to 'Removing the Exhaust Hose' on Page 44.

- 1 Remove the flue from the extraction duct.
- 2 Fit the baffle rest over the edge of the flue. Refer to Figure 19.



**Figure 19.** The baffle rest fits over the top edge of the flue

- 3 Re-attach the flue to the extraction duct.
- 4 If you have a 125 mm duct, unscrew the large adaptor plate from the exhaust hose and screw on the small adaptor plate. If you have a 150 mm duct, the adaptor plate already attached to the accessory will be sufficient for your duct.
- 5 Push the adaptor plate up into the flue at an angle of approximately 30 degrees. Continue to push the plate up until it is above the baffle rest. Refer to Figure 20.
- 6 Use the handle to pull the adaptor plate down into position. The plate should rest on the baffle rest step.

## The GTA Viewing/Fume Extraction Accessory (Optional)

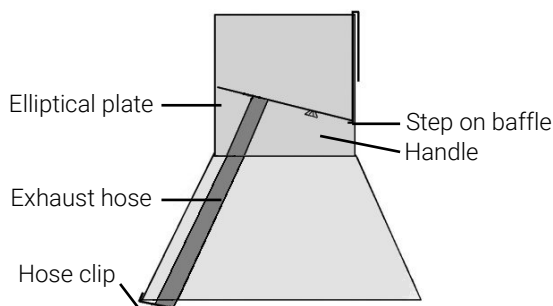

**Figure 20.** The adaptor plate fits onto the baffle rest at approximately a 30° angle

### NOTE

The plate does not fit flat in the flue but should fit snugly, with no more than a 5 mm gap between the edge of the plate and the edge of the flue.

- 7 Adjust the position of the hose clip so that the lip is positioned on the edge of the flue. It is not necessary to physically attach the hose clip to the flue. When correctly adjusted, the hose clip will locate the exhaust hose to the rear of the flue.
- 8 If necessary, reconnect the exhaust hose to the accessory. The exhaust hose should be pushed down into the accessory until it is level with the white block at the bottom of the accessory (see Figure 21 on Page 44).
- 9 Once the GTA viewing/fume extraction accessory has been fitted to the instrument you can use it to view the workhead. Lift the cover on the accessory to illuminate the sample port and view down into the injection hole of the graphite tube, using the mirror built into the accessory.

### CAUTION

**Before running the instrument in flame mode, remove the accessory from both the instrument and the exhaust duct.**

## Operation and Maintenance

### Cover Interlock

The graphite furnace can NOT be started when the cover is open and the viewing mirror is exposed. However, once the furnace has started the cover can be lifted up to enable you to view the inside of the furnace.

## The GTA Viewing/Fume Extraction Accessory (Optional)

### WARNING



#### Hot Surface and Eye Hazard

Do not place hands near the GTA viewing/fume extraction accessory during the atomization stage. You should NOT look into the accessory at this stage or into the mirror if the cover has been lifted up.

### Removing the Exhaust Hose

Refer to Figure 21. To remove the hose, pull it down from the mounting (1) and then pull it out of the accessory (2). You may also want to cut the hose to a length suitable to the installation.

When the hose is reinstalled it should sit approximately level with the base of the white block on the accessory. Refer to Figure 21.

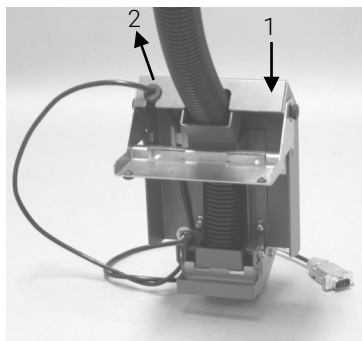

**Figure 21.** The exhaust hose fits all the way into the accessory until it is level with the white block at the bottom. Note the directional arrows.

### NOTE

To remove the exhaust hose from the adapter plate, simply unscrew it.

### Changing Location

To adjust the position of the accessory, tilt the base forwards and lift it up slightly to enable the accessory to move freely. Move the accessory to the desired position and then press it down to lock into place.

## The GTA Viewing/Fume Extraction Accessory (Optional)

### **Cleaning the Mirror**

To clean the mirror, wipe the surface with a soft lint-free cloth. Take care not to put finger marks on the mirror.

If the mirror is particularly dirty, water and detergent can be used before wiping the surface with a soft lint-free cloth.

### **Cleaning the Accessory**

The exposed parts of the GTA viewing/fume extraction accessory are made of corrosion resistant materials. The exposed surfaces of the exhaust inlet should be wiped down with a damp cloth if they become dirty. If the exhaust hose becomes dirty, it may be removed and cleaned with water. Refer to Page 44 for instructions on removing the exhaust hose.

## The GTA Viewing/Fume Extraction Accessory (Optional)

This page is intentionally left blank.

## 6

# Maintenance

General	47
Graphite Shroud and Electrodes	47
Hoses and Connections	48
Cleaning the Quartz Windows	48
Removing and Replacing Electrodes	48
Fuses	56

## General

Clean up spills immediately. If necessary, wipe the cabinet carefully with a damp cloth. Use water or a mild detergent only. Do not use organic solvents or abrasive cleaning agents.

### WARNING



#### Hot Surface

**Parts of the furnace become very hot during use. To prevent burns, ALWAYS allow the furnace to cool before touching.**

## Graphite Shroud and Electrodes

At frequent intervals, inspect the inside of the graphite shroud, which is mounted in the centre cooling block. Also check the contact surfaces of the electrodes.

Using a cotton bud or similar clean the graphite surfaces to remove any loose graphite or other material that may be present. Check to ensure that the bore and the injection hole are free of loose carbon or sample residues.

Check for any pitting on the electrode surface. If necessary replace the electrodes.

### Hoses and Connections

Regularly inspect all hoses and connections (gas and water). You should immediately contact your Agilent field service engineer if you find any leaks.

### Cleaning the Quartz Windows

The quartz window assemblies on either side of the furnace need to be cleaned regularly.

To remove a window assembly, first grasp the knurled edge of the window and then pull it out of the furnace while twisting it.

Carefully clean both sides of the quartz window. Use only alcohol and an optical tissue. **Never** use coarse cloths or abrasive cleaning agents. Inspect the inside of the window mounting and clean off any contamination.

While the window is removed, check the o-ring on the base of the assembly, it should be supple, pliable and free of kinks or cuts. Also check the silicone rubber seal on the window. If either of these are damaged they should be replaced.

If necessary, the complete window assembly can be placed in a detergent solution in an ultrasonic bath. The sonication may help to remove stubborn deposits from the window. After sonication, rinse the window with distilled water and allow to dry before refitting.

To replace the window assemblies, push and twist the assembly back into the electrode housing.

### Removing and Replacing Electrodes

When you first set up your GTA, the electrodes that connect to the graphite tube will appear clean, shiny and smooth. However, over time, the electrodes may become pitted or eroded, and you may see a drop in precision and begin to experience the 'Tube fault' error on new tubes. You should then replace the electrodes.



## Maintenance

Both electrodes are press-fitted into their housings. A tool kit is provided, which enables you to extract and replace the electrodes.

### NOTE

Electrode replacement is a time-consuming procedure. We recommend that you have an Agilent field service engineer perform the procedure. However, if you wish to change them yourself, follow the instructions on Pages 52 and 55.

---

When you are removing and replacing electrodes, you must take the following precautions to avoid poor analytical performance or damage to the electrodes:

- Replace both electrodes—never replace one only.
- Remove the electrode on the right first, then the left electrode.
- Always replace the left electrode first, then the right electrode.
- Remove both electrodes before attempting to fit replacements.
- Use the tooling exactly as described in these instructions.
- When passing the draw bolt through the new electrodes, make sure that the electrode is not damaged by the threaded portion of the bolt.
- Ensure that the electrode is inserted the right way around, as described in these instructions.

### Non-Zeeman Electrode Removal

You will need:

- Electrode removal kit
- Gloves
- Set of new electrodes

## Maintenance

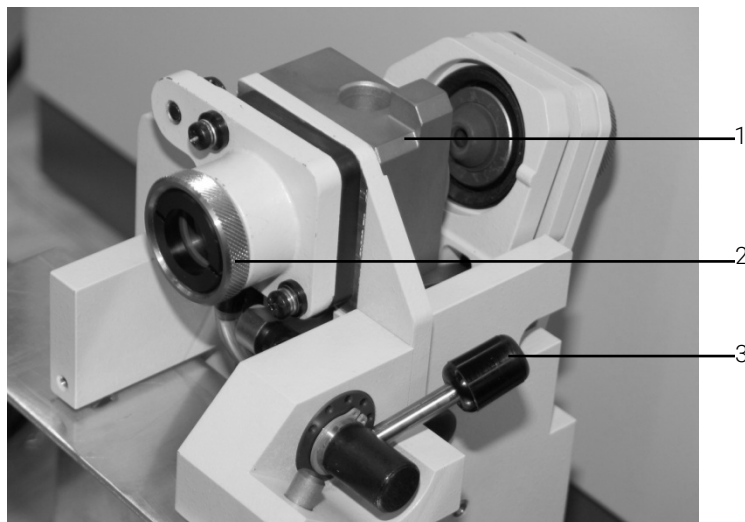

**Figure 22.** The non Zeeman workhead:  
1. Center cooling block, 2. Window, 3. Lever

### NOTE

Make sure you remove the electrode on the right before removing the left electrode.

### To remove the electrodes:

### NOTE

The same procedure is relevant for the removal of both the left and right electrodes, however the orientation of the two are reversed.

- 1 Remove the window assembly from the right-hand electrode housing.
- 2 Open the furnace using the lever, and pull the center cooling block away from the left-hand electrode housing. Position the cooling block over the back of the unit to maximize access to the electrodes. Do not damage the cooling water tubing.
- 3 Pass the bolt from the supplied kit through the electrode on the right from the right side. The threaded portion of the bolt will protrude through the electrode.

## Maintenance

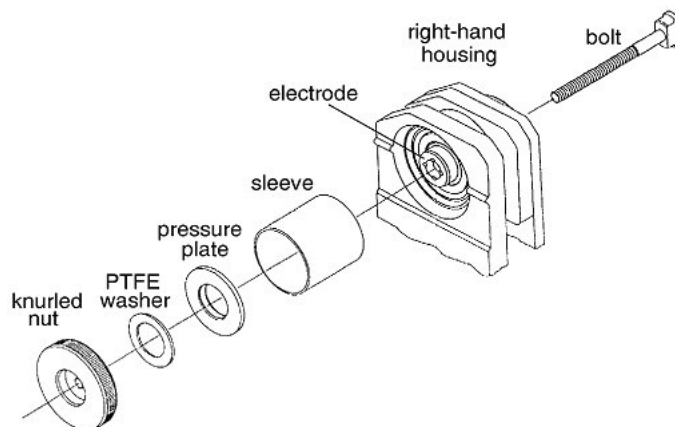

**Figure 23.** Removing the right electrode

- 4 Fit the sleeve over the end of the electrode to bear directly onto the innermost face of the housing.
- 5 Fit the shouldered face of the pressure plate onto the sleeve.
- 6 Put the PTFE washer on the bolt.
- 7 Put the knurled nut on the bolt, and screw it down until the head of the bolt is against the electrode. Make sure the head of the bolt fits into the electrode, with the underside of the head bearing on the end of the electrode.
- 8 Screw the knurled nut down the bolt until the electrode is pulled out. Use the wrench provided.
- 9 Unscrew the nut from the bolt and discard the old electrode.
- 10 Remove the left window.
- 11 Pass the bolt through the left electrode from the left (window) side as before.
- 12 Assemble the sleeve, PTFE washer and knurled nut on the bolt and screw. Tighten the nut to remove the electrode as before.
- 13 Unscrew the nut from the bolt and discard the old electrode.
- 14 Thoroughly clean out the inside of both housings.

## Maintenance

### Non-Zeeman Electrode Replacement

#### NOTE

Make sure you remove the electrode on the right before removing the left electrode. The same procedure is relevant for the removal of both the left and right electrodes, however the orientation of the two are reversed. Powder free nitrile (or fabric) gloves should be used.

#### To replace the electrodes:

- 1 Open the furnace.
- 2 Put the adapter on the bolt, so the bolt head fits into the slot in the adapter. This adapter will protect the electrode during installation.
- 3 Being careful not to damage the electrode, place the electrode over the bolt thread, thinner end first, until it sits in the adapter.

While holding the bolt and adapter onto the electrode, position the electrode against the inner side of the electrode housing.

#### NOTE

Ensure the electrode is straight, so that it goes into the housing aligned.

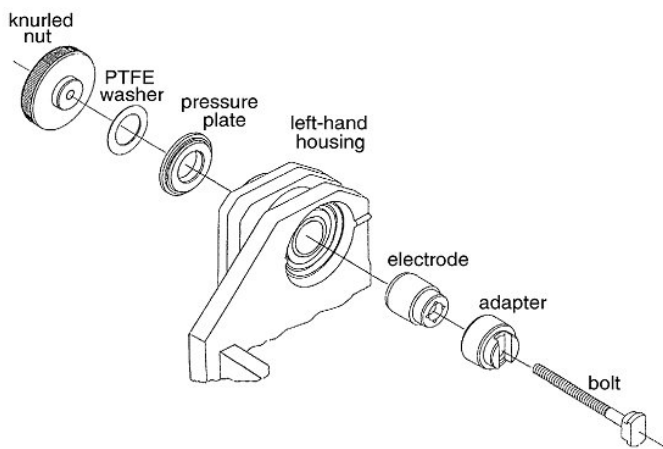

**Figure 24.** Left electrode replacement

- 4 Put the pressure plate and PTFE washer on the bolt, and thread the knurled nut onto the bolt. Using the wrench provided, screw the nut onto the bolt until the assembly is held in position. The shouldered face of the pressure plate fits into the window side of the electrode housing.
- 5 Using the tool provided screw the nut until the electrode is pulled squarely into the housing.

## Maintenance

### NOTE

To avoid cracking the electrode, do not over-tighten the nut. As soon as you feel resistance, stop tightening the nut.

- 6 Unscrew the nut from the bolt and carefully remove the tooling.
- 7 Replace the window in the electrode housing.
- 8 Repeat Steps 1 to 7 for the right-hand electrode.
- 9 After checking that it is clean, replace the center cooling block onto the left-hand electrode housing, being careful not to kink or twist the tubes. Make sure neither tube is wedged between the plates below the cooling block.

## Zeeman Electrode Removal

You will need:

- Zeeman electrode removal kit
- Gloves

### NOTE

Powder free nitrile (or fabric) gloves should be used.

- Set of new electrodes

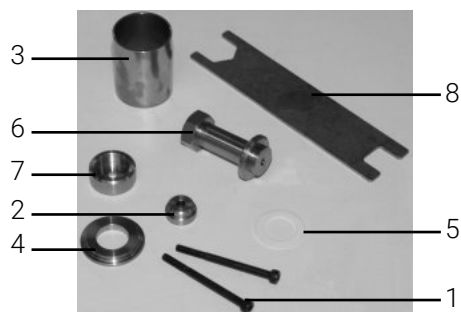

**Figure 25.** Zeeman electrode removal/replacement kit

- |                           |                             |
|---------------------------|-----------------------------|
| 1. Draw bolts (1 spare)   | 5. PTFE washer              |
| 2. Adaptor                | 6. Draw nut assembly        |
| 3. Spacer                 | 7. Electrode pressure plate |
| 4. Stainless steel collar | 8. Removal/replacement tool |

## Maintenance

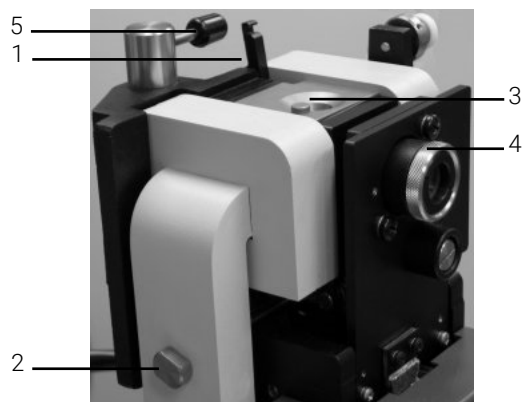

**Figure 26.** The Zeeman workhead

- |                 |                 |
|-----------------|-----------------|
| 1. Latch        | 3. Center block |
| 2. Magnet screw | 4. Window       |
| 5. Lever        |                 |

### NOTE

Before removing the electrodes, remove the furnace from the sample compartment as described on Page 34.

#### To remove the electrodes:

- 1 Remove both window assemblies, by twisting and pulling.
- 2 Flip up the latch (Figure 26, item 1) on top of the furnace.
- 3 Open the furnace using the lever (Figure 26, item 5) and remove the rubber skirt from the right side.
- 4 Loosen the magnet screw (Figure 26, item 2) a few turns.
- 5 Carefully pull the center block (Figure 26, item 3) of the furnace upwards and clear of the workhead. Leave the tubing in place.
- 6 Lay out the components of the electrode replacement tool.
- 7 Pass the drawbolt through electrode on the right (from the outside of the furnace). Refer to Figure 27.

## Maintenance

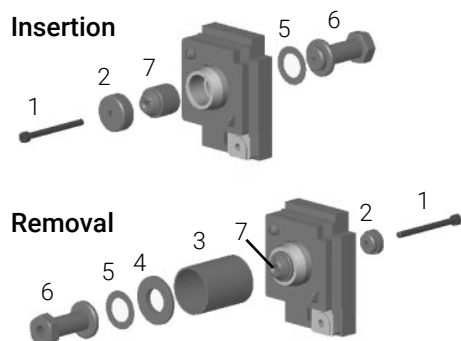

**Figure 27.** Electrode replacement (right hand electrode shown) Zeeman instrument

- |                           |                             |
|---------------------------|-----------------------------|
| 1. Draw bolt              | 5. PTFE washer              |
| 2. Adaptor                | 6. Draw nut assembly        |
| 3. Spacer                 | 7. Electrode pressure plate |
| 4. Stainless steel collar |                             |

- 8 Place the spacer over the electrode on the inside of the furnace.

### NOTE

Ensure that the spacer sits inside the rubber grommet and doesn't pinch the rubber when clamped.

- 9 Place the stainless steel collar, then the PTFE washer and then the draw nut assembly on the draw bolt (refer to Figure 27). The electrode pressure plate component of the tool is not used for the removal process.
- 10 Turn the nut clockwise to draw the electrode into the spacer. Ensure that the draw bolt is not turning (look at the head of the draw bolt through the window hole). If the draw bolt is moving, secure its head with a hex tool.
- 11 Continue turning the nut until the electrode is removed. You may need to use the spanner provided when the nut gets difficult to turn.
- 12 Dismantle the removal tool to extract the electrode. Discard the electrode.
- 13 Remove the left hand electrode using the same procedure.

## Zeeman Electrode Replacement

- 1 Remove any particles of graphite from both electrode bores and clean the bores.
- 2 Insert the narrow end of the electrode into the left hand electrode bore.
- 3 Assemble the insertion tool components as shown in Figure 25.
- 4 Turn the nut clockwise to draw the electrode into the furnace. Check that the electrode is fully home and seated in the bore.

## Maintenance

### CAUTION

**Do not tighten the nut too far as the drawbolt may break, or the electrode may crack. You should be able to feel when the electrode is fully home, as turning the nut will become difficult.**

---

- 5 Release and remove the nut. Remove the other components of the tool from the furnace.
- 6 Repeat Steps 3 to 5 to insert the right hand electrode.

### NOTE

You can check to see if the electrodes are fitted correctly by placing a graphite tube between the two electrodes. Without the center block in place clamp the electrodes together. You should be able to turn the graphite tube with your fingers. If there is too much resistance, the electrodes may need to be pushed in further.

---

- 7 Replace the center block, being careful not to kink or damage the tubes.
- 8 Re-tighten the magnet screw.
- 9 Flip the latch back down.
- 10 Replace the skirt, using a piece of wire to draw the skirt through.
- 11 Clamp the furnace together.
- 12 Replace the workhead windows.

## Fuses

The GTA 120 contains five operator accessible fuses which are located at the back of the accessory. To replace a fuse, disconnect the accessory from the power supply, and replace the blown fuse with one of the type and rating mains indicated below.



## Maintenance



**Figure 28.** Rear of GTA unit

### Fuses

FS3, FS5: T1.6 AL 250 V, 5x20 mm, Littelfuse 0218016 or equivalent

FS4: T2.5 AL 250 V, 5x20 mm, Littelfuse 0239025 or equivalent

FS1, FS2: T1.6 AH 250 V, 5x20 mm, Littelfuse 0215016 or equivalent

### NOTE

For safety reasons, any other internal fuse or circuit breaker is not operator accessible, and should be replaced only by Agilent authorized personnel.

Fuse information on the rear of the instrument is the most up to date.

### WARNING



### Shock Hazard

To prevent reduced safety protection or unwanted fusing, ALWAYS ensure that the code on the fuse cap matches the screening shown adjacent to the fuse holders.

To check a fuse:

- 1 Switch off the GTA and disconnect it from the mains power supply.
- 2 Undo the fuse cap by pressing the cap and turning it counter-clockwise.
- 3 Pull the cap out carefully. The fuse should be held in the fuse cap.

## Maintenance

- 4 Check that the fuse is the correct type and is not damaged. If necessary, replace it.
- 5 Place the fuse into the cap, push the cap in, and then turn the cap clockwise.
- 6 Reconnect the accessory to the mains supply.

### NOTE

If a fuse blows repeatedly, it may indicate other problems with the accessory. You should contact your local Agilent sales office and arrange a service call.

---



# In This Book

The manual describes the following:

- Safety Practices and Hazards
- Introduction
- Getting Started
- Using your GTA
- The GTA Viewing/Fume Extraction Accessory (Optional)
- Maintenance

This information is subject to change without notice.



8510118500  
DE94344959

Edition 12/21  
Issue 11  
Printed in Malaysia

© Agilent Technologies, Inc. 2021

Agilent Technologies Australia [M] Pty Ltd  
679 Springvale Road  
Mulgrave, VIC 3170, Australia

