

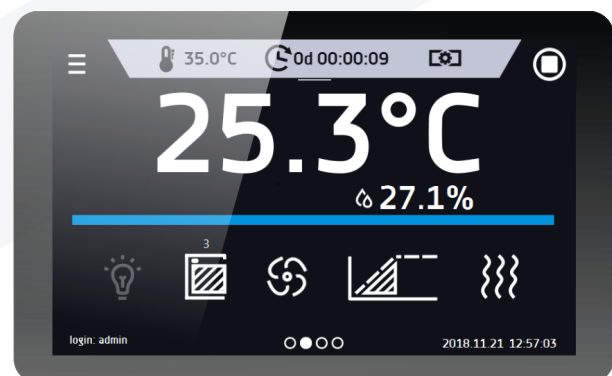

The photo above is for reference only, may show additional options not included in standard equipment. The real appearance, particularly color and structure of the material may differ from the ones presented in the photo.

Advantages of the SMART PRO controller:

- large (7"), clear, full colour touch screen
- LAN, USB ports and WiFi for communication and data transfer
- multi-segment time and temperature programs
- overview of data in tabular and graphic form
- visual and sound alarm
- Admin function for management
- password protected log-in
- internal memory for programs and data storage
- event registry with user notifications
- LabDesk software and user manual for direct download



Smart PRO - preview screen

TECHNICAL DATA

air convection	forced
chamber capacity [l]	462
working capacity [l]	392
controller	microprocessor PID
display	7" full colour touch screen

TEMPERATURE AND HUMIDITY

temperature range [°C]	0...+60
temperature resolution every ... [°C]	0,1
temperature variation at 25°C and 60%rH [±/°C]*	2,0
temperature protection	class 3.3 to DIN 12880
relative humidity range [%]	30...90 (see chart for details)
humidity resolution every ... [%]	1,0
humidity variation at 25°C and 60% rH [%rH]	5,0

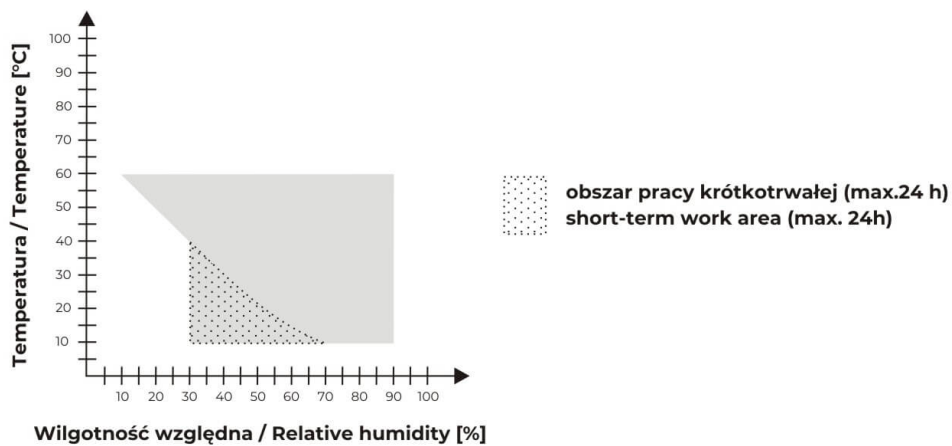

CHAMBER

door type	double (external solid, internal glass) / external glass (option)
interior	
Smart PRO	acid-proof stainless steel to DIN 1.4301
IG Smart PRO	acid-proof stainless steel to DIN 1.4301
housing	
Smart PRO	powder coated sheet
IG Smart PRO	stainless steel linen finish

overall dims [mm] /1/

width A	660
height B	1990
depth C	1080

internal dims [mm]

width D	470
width D'	510
height E	1510
depth F	600
height I	1360

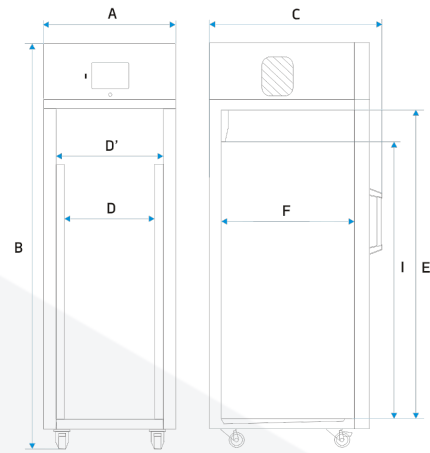

shelves (standard max)	3 11
max shelf workload [kg] /2/	20
- reinforced shelf version (PW) [kg] /3/	100
max unit workload [kg]	100
weight [kg]	130

ELECTRICAL PARAMETERS

voltage**	230V 50-60Hz
nominal power [W]	1850
refrigerant	R290 / GWP=3
warranty	24 months
manufacturer	POL-EKO

all the above technical data refer to standard units (without optional accessories)
 * - variation (K) calculated for chamber as: $K = \pm (T \text{ average max.} - T \text{ average min.}) / 2$
 ** - other power supplies on request
 1 - depth doesn't include 50 mm of power cable
 2 - on uniformly loaded surface
 3 - reinforced shelf

OPTIONS AND ACCESSORIES

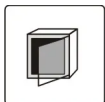

Order number: */A

External glass door



Order number: */P INOX

Stainless steel wire shelf INOX

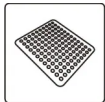

Order number: */PP

Perforated shelf

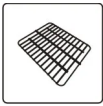

Order number: */PW

Reinforced shelf



Order number: KUW GN*/*

Stainless steel cuvettes



Order number: */FIT

Phytotron system



Order number: FIT/R3

FIT panels independent control

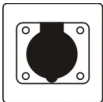

Order number: GNZ

Internal socket

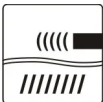

Order number: KK/CP

Low water level sensor



Order number: BRT*/L or IQ/OQ/PQ

Calibration and IQ, OQ, PQ qualification



Order number: BPP 12

Battery backup for display



Order number: PORT ALARM

Dry alarm contact

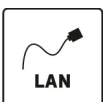

Order number: LANK

LAN cable

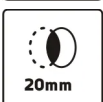

Order number: OCZ/20

Non-standard access port 20 mm

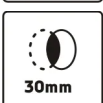

Order number: OCZ/30

Additional access port 30 mm

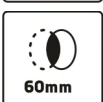

Order number: OCZ/60

Non-standard access port 60 mm

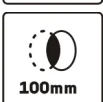

Order number: OCZ/100

Non-standard access port 100 mm



Order number: KK/Z

Container for deionised water

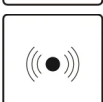

Order number: KD

Access control