



# Instruction Manual

## Shaker, Rocking, 1 Tier, SHRK07AL1

EN - English ..... 1

CZ - Czech ..... 100  
KR - Korean ..... 105  
JP - Japanese ..... 117



Revision 5  
2/14/2020

TABLE OF CONTENTS

Package contents . . . . .	1
Service information . . . . .	1
Installation . . . . .	2
Maintenance & servicing . . . . .	2
Intended use . . . . .	2
Environmental conditions . . . . .	2
Equipment disposal . . . . .	2
Safety instructions. . . . .	3
Standards & regulations. . . . .	3
Analog Rocking/Waving Shaker Specifications . . . . .	4
Analog Rocking/Waving Shaker Control Panel . . . . .	5
Analog Rocking/Waving Shaker Operating Instructions . . . . .	5
Digital Rocking Shaker Specifications . . . . .	6
Digital Waving Shaker Specifications . . . . .	7
Digital Rocking/Waving Shaker Control Panel . . . . .	8
Digital Rocking/Waving Shaker Operating Instructions . . . . .	9-10
Troubleshooting . . . . .	11

PACKAGE CONTENTS

- Rocking Shaker 1 Tier or
- Rocking Shaker 2 Tier or
- Waving Shaker Analog or
- Waving Shaker Digital
- Non-skid rubber mat
- Power Cord
- Tier kit (analog rocker 2 tier)
- Instruction manual
- Warranty card

If the troubleshooting section does not resolve or describe your problem, contact your authorized OHAUS service agent. For service assistance or technical support in the United States call toll-free 1-800-672-7722 ext. 7852 between 8:00 AM and 5:00 PM EST. An OHAUS product service specialist will be available to provide assistance. Outside the USA, please visit our web site, [www.ohaus.com](http://www.ohaus.com) to locate the Ohaus office nearest you.

Serial Number: \_\_\_\_\_

Date of Purchase: \_\_\_\_\_

Supplier: \_\_\_\_\_

## INSTALLATION

Upon receiving the Ohaus Rocking/Waving Shaker, check to ensure that no damage has occurred during shipment. It is important that any damage that occurred in transport is detected at the time of unpacking. If you do find such damage the carrier must be notified immediately.

After unpacking, place the Rocking/Waving Shaker on a level bench or table, away from explosive vapors. Ensure that the surface on which the unit is placed will withstand typical heat produced by the unit. Always place the unit on a sturdy work surface.

The Rocking/Waving Shaker is supplied with a power cord that is inserted into the IEC connector on the back of the unit first, then it can be plugged into a properly grounded outlet. The 120V unit plugs into a 120 volt, 50/60 Hz source. The 230V unit plugs into a 230 volt, 50/60 Hz source.

## MAINTENANCE & SERVICING

The Rocking/Waving Shaker is built for long, trouble-free, dependable service. No lubrication or other technical user maintenance is required. However at least every three (3) months you should:

- Unplug the unit.
- Remove any accumulated dirt from the base and tray.
- Check all accessible items to make sure they are properly tightened.

The unit should be given the care normally required for any electrical appliance. Avoid wetting or unnecessary exposure to fumes. Spills should be removed promptly. **DO NOT** use a cleaning agent or solvent on the front panel which is abrasive or harmful to plastics, nor one which is flammable. Always ensure the power is disconnected from the unit prior to any cleaning. If the unit ever requires service, contact your Ohaus representative.

## INTENDED USE

The Rocker/Waver is intended for general laboratory use.

## ENVIRONMENTAL CONDITIONS

**Operating Conditions:** Indoor use only.

\*For use in CO<sub>2</sub> environments, incubators or cold rooms.

\*Temperature: -10 to 60°C (14 to 140°F).

Humidity: maximum 80% relative humidity, non-condensing

Altitude: 0 to 6,562 ft (2000 M) above sea level

Mains supply voltage: Fluctuations are not to exceed 10 percent of the nominal supply voltage.

**Non-Operating Storage:**

\*Temperature: -20 to 65°C (-4 to 149°F)

Humidity: maximum 80% relative humidity, non-condensing

Installation Category II and Pollution Degree 2 in accordance with IEC 664.

**\*Avoid cold starts:** Unit is not designed to start after being in a cold room environment. Bring unit into cold room from a room temperature environment, operate and remove unit from cold room as soon as operation is complete.

## EQUIPMENT DISPOSAL



This equipment must not be disposed of with unsorted waste. It is your responsibility to correctly dispose of the equipment at life-cycle-end by handing it over to an authorized facility for separate collection and recycling. It is also your responsibility to decontaminate the equipment in case of biological, chemical and/or radiological contamination, so as to protect the persons involved in the disposal and recycling of the equipment from health hazards.

For more information about where you can drop off your waste of equipment, please contact your local dealer from whom you originally purchased this equipment. By doing so, you will help to conserve natural and environmental resources and you will ensure that your equipment is recycled in a manner that protects human health.

## SAFETY INSTRUCTIONS

Please read the entire instruction manual before operating the Rocking/Waving Shaker.



**WARNING! DO NOT** use the Rocking/Waving Shaker in a hazardous atmosphere or with hazardous materials for which the unit was not designed. Also, the user should be aware that the protection provided by the equipment may be impaired if used with accessories not provided or recommended by the manufacturer, or used in a manner not specified by the manufacturer.

Always operate unit on a level surface for best performance and maximum safety.

**DO NOT** lift unit by the tray.



**CAUTION!** To avoid electrical shock, completely cut off power to the unit by disconnecting the power cord from the unit or unplug from the wall outlet. Disconnect unit from the power supply prior to maintenance and servicing.

Spills should be removed promptly. Biohazard spills should be cleaned up using approved laboratory procedures. Solvent spills are a fire hazard. Stop the unit immediately, and **DO NOT** operate until clean up is complete and vapors have dissipated (motor brushes arc and may ignite flammable vapors). **DO NOT** immerse the unit for cleaning.

**DO NOT** operate the unit if it shows signs of electrical or mechanical damage.

The main supply cord provided with this product is rated to safely handle the products electrical load under the stated environmental conditions. **DO NOT** replace this cord with an inadequately rated main supply cord.







Earth Ground - Protective Conductor Terminal



Alternating Current

## STANDARDS & REGULATIONS

Compliance to the following standards and regulations is indicated by the corresponding mark on the product.

Mark	Standards and Regulations
	OHAUS Corporation declares that the SHRK, SHWV series shakers comply with directives 2011/65/EU, 2014/30/EU, 2014/35/EU and standards EN 50581, EN 61010-1, EN 61010-2-051, EN 61326-1. The full text of the EU declaration of conformity is available at the following internet address: <a href="http://www.ohaus.com/ce">www.ohaus.com/ce</a> .
	This product complies with directive 2012/19/EU. Please dispose of this product in accordance with local regulations at the collecting point specified for electrical and electronic equipment. For disposal instructions in Europe, refer to <a href="http://www.ohaus.com/weee">www.ohaus.com/weee</a> .
	EN 61326-1
	CAN/CSA C22.2 61010-1, CAN/CSA C22.2 61010-2-051 UL 61010-1, UL 61010-2-051

### Global Notice

Warning: This is a Class A product. In a domestic environment this product may cause radio interference in which case the user may be required to take adequate measures.

### Canada Notice

This Class A digital apparatus complies with Canadian ICES-003.

### FCC Notice

NOTE: This equipment has been tested and found to comply with the limits for a Class A digital device, pursuant to Part 15 of the FCC Rules. These limits are designed to provide reasonable protection against harmful interference when the equipment is operated in a commercial environment. This equipment generates, uses, and can radiate radio frequency energy and, if not installed and used in accordance with the instruction manual, may cause harmful interference to radio communications. Operation of this equipment in a residential area is likely to cause harmful interference in which case the user will be required to correct the interference at his own expense.

Changes or modifications not expressly approved by Ohaus Corporation could void the user's authority to operate the equipment.

## ANALOG ROCKING/WAVING SHAKER SPECIFICATIONS



### Overall dimensions (L x W x H):

Rocker: 16.8 x 11.0 x 5.5" (42.5 x 27.9 x 14.0cm)

Waver: 16.8 x 11.0 x 6.5" (42.5 x 27.9 x 16.5cm)

### Tray dimensions (L x W):

14 x 11" (35.5 x 27.9cm)

### Electrical (50/60 Hz):

Rocker: 120 volts, 15 watts  
230 volts, 15 watts

Waver: 120 volts, 25 watts  
230 volts, 25 watts

### Fuses:

5mm x 20mm, 5 amp quick acting

### Speed range:

1 to 75rpm\*

### Tilt angle:

Rocker: 0 to 15\*\*

Waver: 0 to 16\*\*

### Weight capacity:

Rocker: 16lbs (7.3kg)\*\*

Waver: 5lbs (2.3kg)\*\*

### Timer:

1 minute to 120 minutes

### Controls:

see page 5

### Ship weight:

15.5lbs (7kg)

\* Maximum speed/tilt angle may vary with heavy or unbalanced loads.

\*\* Centered on tray.

## ANALOG ROCKING/WAVING SHAKER CONTROL PANEL

The front panel of the Analog Rocker contains all the controls and displays needed to operate the unit.

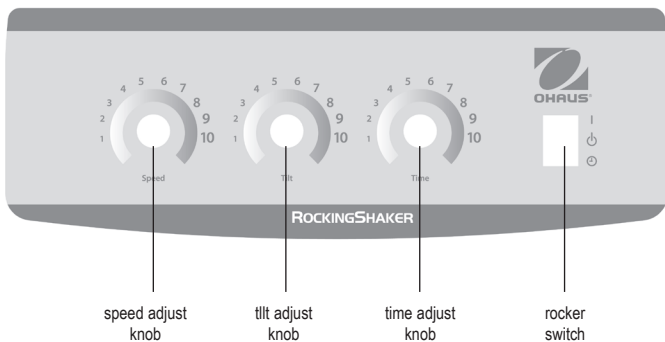

## ANALOG ROCKING/WAVING SHAKER OPERATING INSTRUCTIONS

### 1. Getting ready:

- Rocker switch should be in the center Standby position.
- Plug the power cord into a properly grounded outlet. Manually move the tray to a near horizontal "home" position before powering the unit.
- Position Speed and Tilt knobs between 2 and 3 on the dial.
- Push rocker switch to the "I" On position. The rocker will automatically level and begin running at a moderate speed and tilt.

### 2. Setting speed and tilt:

- Turn Speed and Tilt knobs to achieve the desired settings.

### 3. Setting time:

- To run in timed mode, set timer, speed, and  tilt knobs to the desired settings.
- Press the rocker switch down to the Time position and release.
- The unit will now run for the set time.
- To exit the Time mode, press the rocker switch up and return it to the center Standby position.

**NOTE:** After the timer is set, any time adjustments will not take affect. To reset time, exit Time mode (see step 3d above) and enter new time following the steps above.

### OPERATING TIPS:

Centering your sample and even weight distribution on the tray helps balance and stability.

## DIGITAL ROCKING SHAKER SPECIFICATIONS



<b>Overall dimensions (L x W x H):</b>	16.8 x 10.0 x 5.5" (42.5 x 25.4 x 140cm)
<b>Tray dimensions (L x W):</b>	12.75 x 10" (32.4 x 25.4cm)
<b>Electrical (50/60 Hz):</b>	120 volts: 25 watts 230 volts: 25 watts
<b>Fuses:</b>	5mm x 20mm, 5 amp quick acting
<b>Speed range:</b>	1 to 50rpm *
<b>Speed accuracy:</b>	±1rpm
<b>Tilt angle:</b>	0 to 15° *
<b>Timer:</b>	1 second to 9999 minutes (increased in 1 second increments)
<b>Maximum weight capacity:</b>	10lbs (4.5kg) **
<b>Controls:</b>	see page 8
<b>Tray material:</b>	aluminum
<b>Ship weight:</b>	15.5lbs (7kg)

\* Maximum speed/tilt angle may vary with heavy or unbalanced loads.

\*\* Centered on tray.

Digital Rocking Shaker with glassware and plasticware

## DIGITAL WAVING SHAKER SPECIFICATIONS



<b>Overall dimensions (L x W x H):</b>	17 x 11 x 6" (43.2 x 27.9 x 15.2cm)
<b>Tray dimensions (L x W):</b>	11.75 x 8.75" (29.9 x 22.2cm)
<b>Electrical (50/60 Hz):</b>	120 volts: 25 watts 230 volts: 25 watts
<b>Fuses:</b>	5mm x 20mm, 5 amp quick acting
<b>Speed range:</b>	1 to 30rpm *
<b>Speed accuracy:</b>	±1rpm
<b>Tilt angle:</b>	0 to 20° *
<b>Timer:</b>	1 second to 9999 minutes (increased in 1 second increments)
<b>Maximum weight capacity:</b>	5lbs (2.3kg) **
<b>Controls:</b>	see page 8
<b>Tray material:</b>	aluminum
<b>Ship weight:</b>	16lbs (7.3kg)

\* Maximum speed/tilt angle may vary with heavy or unbalanced loads.

\*\* Centered on tray.

Digital Waving Shaker



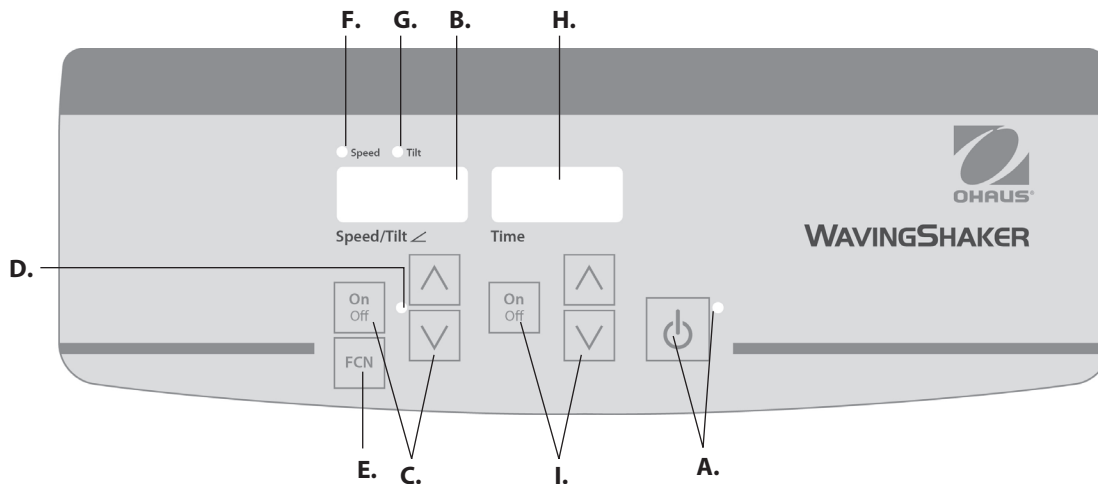

## DIGITAL ROCKING/WAVING SHAKER CONTROL PANEL

The front panel of the Rocking/Waving Shaker contains all the controls and displays needed to operate the unit.

**A. Standby button/standby indicator light:** The standby indicator light will illuminate when the unit is plugged in. The unit will be in standby mode. Press the standby button to activate the speed/tilt angle and time functions. The standby indicator light will shut off and the speed/tilt angle display and time display will illuminate. Press the standby button again and the unit will once again be in standby mode.

**B. Speed/tilt angle display:** Displays the speed and tilt angle of the unit. **C.** Up/down arrows for set-point control. **On/off** button starts/stops the rocking/waving function. **D.** The speed/tilt angle indicator light will be illuminated when the unit is rocking/waving.

**E. Function button:** Press to choose the function you are setting: speed or tilt.

**F. Speed indicator light:** Illuminates when the speed is displayed.

**G. Tilt indicator light:** Illuminates when the tilt angle is displayed.

**H. Time display:** Displays accumulated time (continuous mode) or how much time is remaining (timed mode). The display range is from 0 to 9,999 minutes in one (1) second increments. The display will indicate minutes and seconds until the timer reaches 99 minutes and 59 seconds (99:59), then the display will automatically display minutes up to 9,999.

**I.** Up/down arrows for set-point control. **On/off** button starts/stops the time function

## DIGITAL ROCKING/WAVING SHAKER OPERATING INSTRUCTIONS

The Rocking/Waving Shakers have been designed for the speed/tilt angle and time functions to work independently of one another. The speed/tilt angle can be reset without resetting the timer and the timer can be stopped and started without interrupting the rocking/waving function.

### 1. Getting ready:

- a. Plug the power cord into a properly grounded outlet. The standby indicator light will illuminate, verifying power to the unit. Manually move the tray to a near horizontal "home" position before powering unit.
- b. Press the standby button to move the unit from standby mode. The standby indicator light will turn off and the speed/tilt angle and time displays will illuminate, displaying the previously used settings.



### 2. Setting tilt angle:

Electronic tilt enables the user to adjust the angle of tray movement while the unit is rocking/waving or while the unit is stopped.

- a. Press the function button below the speed/tilt angle display until the tilt indicator light illuminates. You are now ready to set the tilt angle.
- b. Press the up/down arrows below the speed/tilt angle display until you reach the desired angle. When you release the button, the display will blink off and then on indicating the new set angle has been accepted. The unit will complete one rotation at the previously set angle, then smoothly change to the newly programmed angle. The tilt indicator light will flash until the transition to the new tilt angle is complete.

### 3. Setting speed:

- a. Press the function button below the speed/tilt angle display until the speed indicator light illuminates. You are now ready to set the speed.
- b. Press the up/down arrows below the speed/tilt angle display until you reach the desired speed. When you release the button, the display will blink off and then on indicating the new set speed has been accepted.

- c. Press the on/off button to start the rocking/waving function. The indicator light below the speed/tilt angle display will illuminate and blink until the set-point is reached. Once the set-point is reached the light will stop blinking and remain lit until rocking/waving has ceased.
- d. To stop the rocking/waving function, press the on/off button below the speed/tilt angle display. The unit will complete one full rotation then stop in the horizontal "home" position. The speed indicator light will flash until the rotation is complete. When the cycle is complete, the unit will automatically move to standby mode and the standby indicator light will illuminate.

### OPERATING TIPS

When the unit is running at slow speeds or high angles, making large changes to the tilt angle or speed may take several minutes to complete. The quickest way to make large changes is to stop the unit, change the speed or tilt angle, then restart by pressing the on/off button below the speed/tilt angle display.

4. **Setting time to zero (0:00) and continuous mode:** Accumulated time.
  - a. Press and hold the on/off button below the time display. After three (3) seconds the display will indicate the previous set time.
  - b. Simultaneously press both the up and down arrows, the display will indicate zero (0:00). The unit time is now set to zero (0:00) minutes. Alternately, you can use the up/down arrows to get to zero (0:00).
  - c. Press the on/off button below the time display. The display will indicate accumulated time. The up/down arrows will become inactive. To stop timer, press the on/off button again. **IMPORTANT:** This will **NOT** interrupt the rocking/waving function. Press the on/off button below the speed/tilt angle display to interrupt the rocking/waving function.
  - d. To reset, press and hold the on/off button below the time display. After three (3) seconds the display will indicate the previous set time, which was zero (0:00).

## DIGITAL ROCKING/WAVING SHAKER OPERATING INSTRUCTIONS CONT'D

### 5. **Setting timed mode:** Programmed time.

- a. Press the up/down arrows below the time display until you reach the desired time.
- b. Start this function by pressing the on/off button below the time display. The unit will run for the selected time, the up/down arrows will become inactive while the timer is running. The unit will stop rocking/waving when the time display reaches zero (0:00). Four (4) audible beeps will indicate the count down function is complete. The time display will default back to the set time. To repeat for the same time, simply press the on/off button again.
- c. To interrupt an automatic timing cycle before it is completed, press the on/off button below the time display. The time display will flash off and on to indicate the time function is on "hold". **IMPORTANT:** This will **NOT** interrupt the rocking/waving function. Press the on/off button below the speed/tilt angle display to interrupt the rocking/waving function. Restart the timer by pressing the on/off button below the time display. Unit will continue counting down to zero (0:00). When the display reaches zero (0:00), you will hear the four (4) audible beeps that indicate the count down function is complete and the rocking/waving function will cease.

### 6. **Turning unit off:**

- a. To turn the unit off, press the standby button. The speed/tilt angle and time displays will be blank, the standby indicator light will illuminate. The Rocking/Waving Shaker should be kept in standby mode when not in use. To completely cut off power to the unit, disconnect the power cord from the unit or unplug from the wall outlet.

### OPERATING TIPS

As a safety feature, a built-in program will shut power off to the motor if the tray is prevented from rocking/waving, or the unit is overloaded beyond its recommended weight capacity.

Built-in memory maintains the last used speed/tilt angle and time settings during a power interruption.

## TROUBLESHOOTING ANALOG ROCKER/WAVER

If the tray motion is obstructed or the unit is mechanically overloaded, the unit will beep and attempt to restore controlled rocking motion. If unit can not recover on its own, disconnect power cord, reduce load, speed or tilt setting and repeat run.

## TROUBLESHOOTING DIGITAL ROCKER/WAVER

Problem	Cause	Solution
E03	Mechanical obstruction Ceased motor Drive belt broken	<p>The E03 error can be addressed by the user. Press the standby button to clear this error. If the E03 error persists, along with grinding, knocking or rubbing noises, un-plug the unit and contact your Ohaus representative for repairs.</p> <p>In the event of an errant E03 error, such as someone inadvertently touching the platform tray while the unit is running, the unit will automatically go to the horizontal “home” position and restart. In the event of an obstruction left under the tray, which would cause the unit to continually restart, the unit will attempt to auto home and restart four (4) times and then stop running, displaying an E03 error. This error can be cleared by the user by pressing the standby button.</p>
E04	Maximum load exceeded	<p>The E04 error can be addressed by the user. Press the standby button to clear this error. Be sure the load is within the maximum load specification before restarting the unit. If the E04 code persists, un-plug the unit and contact your Ohaus representative for repairs.</p>