

QuantStudio™ 6 and 7 Flex Real-Time PCR Systems

USER GUIDE

Maintenance and Administration

for use with QuantStudio™ Real-Time PCR Software v1.3

Publication Number 4489821

Revision B



For Research Use Only. Not for use in diagnostic procedures.



The information in this guide is subject to change without notice.

DISCLAIMER: TO THE EXTENT ALLOWED BY LAW, THERMO FISHER SCIENTIFIC INC. AND/OR ITS AFFILIATE(S) WILL NOT BE LIABLE FOR SPECIAL, INCIDENTAL, INDIRECT, PUNITIVE, MULTIPLE, OR CONSEQUENTIAL DAMAGES IN CONNECTION WITH OR ARISING FROM THIS DOCUMENT, INCLUDING YOUR USE OF IT.

Revision history: Pub. No. 4489821

Revision	Date	Description
B	22 August 2022	<ul style="list-style-type: none"> The branding was updated. The statement covering limited use label licenses was updated. The name of the software was updated to the QuantStudio™ Real-Time PCR Software and the base software does not require a license. The firewall ports that must be open were added. The Twister™ Robot was removed. The volume of deionized water to create a background plate was updated (“Create a background plate” on page 153). The volume to determine the optimum dye concentration for a custom dye was updated (“Determine optimum dye concentration” on page 155). The volume of dye was updated when creating a custom dye plate for calibration (“Create a custom dye plate” on page 156). The consumables and storage temperatures were updated (“Kits, consumables, and accessories” on page 160). The instructions to order from the website were removed. The safety and electromagnetic compatibility standards were updated. The environmental design standards were updated.
A	November 2013	New document for the QuantStudio™ 6 and 7 Flex Real-Time PCR Systems.

Important Licensing Information: These products may be covered by one or more Limited Use Label Licenses. By use of these products, you accept the terms and conditions of all applicable Limited Use Label Licenses.

TRADEMARKS: All trademarks are the property of Thermo Fisher Scientific and its subsidiaries unless otherwise specified. Internet Explorer, Excel, Microsoft, and Windows are registered trademarks of Microsoft Corporation. Cy is a registered trademark of Global Life Sciences Solutions Germany GmbH. Safari, Apple, and Macintosh are registered trademarks of Apple, Inc. Mozilla and Firefox are registered trademarks of Mozilla Foundation. Adobe and Acrobat are registered trademarks of Adobe Systems, Inc. Twister is a registered trademark of Caliper Life Sciences, Inc. TaqMan is a trademark of Roche Molecular Systems, Inc., used under permission and license.

©2022 Thermo Fisher Scientific Inc. All rights reserved.

Contents

About this guide	10
Purpose	10
Audience	10
Assumptions	10
User attention words	11
Symbols on this instrument	11
Contents of this manual	11
■ CHAPTER 1 Getting started	13
Differences between the QuantStudio™ 6 and 7 Flex Real-Time PCR Systems	13
About the QuantStudio™ 6 and 7 Flex Real-Time PCR Systems	13
Data collection	14
Instrument filters and supported dyes	15
Instrument hardware	16
Front	17
Rear	18
Barcode scanner	19
Electrical protective devices	20
Instrument software	20
Computer requirements	21
Software installation	21
Third-party software	21
Third-party software	21
Instrument consumables	22
Interchangeable sample blocks, heated covers, and plate retainers	23
■ CHAPTER 2 Calibrate the instrument	24
Calibration overview	25
Calibration and maintenance schedule	25
Planned maintenance	26
About maintenance reminders	26

Calibration workflow	26
View the calibration status of an instrument	27
Enable or change the calibration reminders	29
Requirements to email calibration reminders	29
Define the mail server settings	29
Modify the notification settings for a monitored instrument	31
Guidelines for preparing calibration plates and array cards	32
Preparing array cards for instrument calibration	33
Required materials	33
Fill the calibration TaqMan™ Array Cards	34
ROI calibration	37
When to perform the calibration	37
About the calibration data	38
Preparing the calibration plate or array card	38
Prepare the ROI calibration plate	38
Perform the ROI calibration	39
Background calibration	42
When to perform the calibration	42
About the calibration data	42
Preparing the calibration plate or array card	42
Prepare the background calibration plate	42
Perform the background calibration	43
Uniformity calibration	46
When to perform the calibration	46
Preparing the calibration plate or array card	46
Prepare the ROI calibration plate	46
Perform the uniformity calibration	47
Dye calibration	49
When to perform the calibration	49
About the dye calibration data	50
Preparing the calibration plate or array card	50
Prepare the dye calibration plates	51
Perform the dye calibration	52
Normalization calibration	55
When to perform the calibration	55
About the calibration data	55
Preparing the calibration plate or array card	55
Prepare the normalization calibration plates	55
Perform the normalization calibration	56
Verify the instrument performance	59
When to perform the test	59
About the RNase P kits	59
Analytical performance	61
Installation specification	62
Prepare the RNase P plate	62

Preparing an array card for instrument verification	64
Run the RNase P plate or array card	66
Troubleshooting	71
How to identify contamination	80
Remove a plate stuck within the instrument	81
■ APPENDIX A Manual instrument operation	82
Overview of instrument touchscreen functions	82
Operate the instrument from the touchscreen	83
Create an experiment from a template	83
Run an experiment	84
Transfer experiments, templates, and results data	85
Maintain the instrument from the touchscreen	87
Back up and restore the instrument settings	87
Perform an instrument self test	89
Update the instrument firmware	89
Administrate the instrument from the touchscreen	90
Define the date and time	91
Define the instrument settings	91
Define the maintenance reminders	93
Define the network settings	93
Define the system shortcuts	94
Review the instrument statistics	95
Review the instrument version information	95
Enable or disable instrument security	95
View the instrument log	96
■ APPENDIX B Maintenance	97
Decontaminate the sample block	97
Materials required	98
How to handle the sample block	98
Clean the sample block	98
Replace the halogen lamp	100
Materials required	101
Halogen lamp warnings	101
View the lamp status	101
Replace the lamp	101
Replace the instrument fuses	104
Materials required	104
Replace the fuses	104
Install the QuantStudio™ Real-Time PCR Software	105
Computer requirements	105
Install the software	105

Software licenses	105
Activate a license	105
Install a license file	106
Update the QuantStudio™ Real-Time PCR Software	106
Update the software	107
Update the Microsoft™ Windows™ operating system	107
Change the sample block	107
When to change the sample block	107
Materials required	108
How to handle the sample block	108
Change the sample block	108
Change the heated cover	110
When to change the heated cover	110
Materials required	110
How to handle the heated cover	110
Change the heated cover	110
Change the plate adapter	112
When to change the plate adapter	112
Materials required	112
Change the plate adapter	113
■ APPENDIX C Networking	114
Networking overview	114
Controlling and monitoring networked QuantStudio™ 6 and 7 Flex Systems	114
About the ethernet port	115
Firewall ports that must be open	115
Example network layouts	116
Networking guidelines and best practices	117
Network setup workflow	118
Collect the required network information	118
Connect the QuantStudio™ 6 or 7 Flex System to the network	118
Materials required	118
Define the instrument internet protocol settings	119
Connect the computer to the network	120
Materials required	120
Computer requirement	120
Collect required information	120
Set up the computer	120
Install the QuantStudio™ Real-Time PCR Software	121
Monitor the QuantStudio™ 6 or 7 Flex Real-Time PCR System	121
About remote monitoring	122
Monitor the status of a run from the QuantStudio™ Real-Time PCR Software	122
Download experiment files	122
Enable or change the calibration reminders	123

■	APPENDIX D	Power on or off, store, and move	125
		Place the QuantStudio™ 6 or 7 Flex Real-Time PCR System on standby	125
		Power on the QuantStudio™ 6 or 7 Flex Real-Time PCR System	125
		Power off the QuantStudio™ 6 or 7 Flex Real-Time PCR System	126
		Store the QuantStudio™ 6 or 7 Flex System	127
		Materials required	127
		Prepare the QuantStudio™ 6 or 7 Flex Real-Time PCR System	127
		Move the QuantStudio™ 6 or 7 Flex System	128
		How to handle the sample block and heated cover	129
		Prepare the QuantStudio™ 6 or 7 Flex System components	129
		Move the QuantStudio™ 6 or 7 Flex System	130
		Reinstall the QuantStudio™ 6 or 7 Flex System	130
■	APPENDIX E	Security, audit, and electronic signature	132
		Administrator overview	132
		Example applications	133
		Configure the security system	133
		Access the Security screen and enable or disable security	133
		Set account setup and security policies	134
		Set up messaging notifications	135
		User account management	136
		Create or edit user accounts	136
		Determine the name of the logged-in user	137
		Create or edit a user role	137
		View or print a user report	139
		Audit trail management	140
		Access the audit screen and enable or disable auditing	140
		Modify the auditing settings	140
		Audit report generation	141
		Viewing audit histories from the security settings dialog box	141
		Viewing audit histories from an experiment, template, or study	144
		Manage electronic signature	145
		Access the e-signature settings screen, and enable or disable the e-signature	145
		Configure the meanings of the electronic signatures	146
		Configure the e-signature rights for user roles	146
		Select the actions that require signature	147
		How the software prompts electronic signature	148
		Generate e-signature reports	148

Export and import user, security, audit, and e-signature settings	149
User overview	150
User account permissions	150
Account suspension	150
Session time-out	150
User security tasks	151
■ APPENDIX F Calibration consumable preparation	152
Create a background plate or array card	152
Required materials	152
Create a background plate	153
Create a background array card (<i>QuantStudio™ 7 Flex System only</i>)	153
Create a custom dye plate for calibration	154
Before you use custom dyes	154
Required materials	154
Determine optimum dye concentration	155
Create a custom dye plate	156
Add the custom dye to the software	156
■ APPENDIX G Parts and materials	159
How to order	159
How to order from the system software	159
Kits, consumables, and accessories	160
96-well 0.2-mL consumables	161
96-well 0.1-mL consumables	161
384-well consumables	162
TaqMan™ Array Card consumables	162
QuantStudio™ 6 and 7 Flex Systems accessories	163
QuantStudio™ 6 and 7 Flex Systems empty plates and array cards	164
General-use materials and consumables	164
■ APPENDIX H Instrument specification and layout	165
QuantStudio™ 6 and 7 Flex Systems specifications	165
Required clearances	167
Electrical requirements	167
Environmental requirements	168
Network requirements	168
QuantStudio™ 6 and 7 Flex Systems layout and connections	169

■ APPENDIX I Safety	171
Symbols on this instrument	171
Standard safety symbols	172
Additional safety symbols	173
Location of safety labels	174
Control and connection symbols	175
Conformity symbols	175
Safety information for instruments not manufactured by Thermo Fisher Scientific	176
Instrument safety	176
General	176
Physical injury	176
Electrical safety	177
Cleaning and decontamination	178
Instrument component and accessory disposal	178
Laser safety—barcode scanner	178
Workstation safety	179
Safety and electromagnetic compatibility (EMC) standards	179
Safety standards	180
EMC standards	180
Environmental design standards	180
Chemical safety	181
Biological hazard safety	182
■ APPENDIX J Documentation and support	183
Related documentation	183
Customer and technical support	183
Limited product warranty	184
Glossary	185

About this guide

Purpose

This user guide provides reference information for the QuantStudio™ 6 and 7 Flex Real-Time PCR Systems and describes how to prepare, maintain, and troubleshoot the systems.



WARNING! The protection provided by the equipment may be impaired if the instrument is operated outside the environment and use specifications, the user provides inadequate maintenance, or the equipment is used in a manner not specified by the manufacturer (Thermo Fisher Scientific).

Note: For information and instructions on performing experiments on the QuantStudio™ 6 and 7 Flex Real-Time PCR Systems, see the following documents:

- *QuantStudio™ Real-Time PCR Software Getting Started Guide* (Pub. No. 4489822)
 - *High Resolution Melt Module for QuantStudio™ 6 and 7 Flex Real-Time PCR System Software Getting Started Guide* (Pub. No. 4489823)
 - *QuantStudio™ 6 and 7 Flex Real-Time PCR Systems Quick Reference* (Pub. No. 4489826)
-

Audience

This user guide is written for laboratory staff who operate and maintain the QuantStudio™ 6 and 7 Flex Real-Time PCR Systems.

Assumptions

This guide assumes that your QuantStudio™ 6 and/or 7 Flex System has been installed by a Thermo Fisher Scientific service representative.

This guide also assumes that you have:

- Familiarity with Microsoft™ Windows™ operating system.
- Knowledge of techniques for handling and preparing nucleic acid samples for PCR.
- A general understanding of data storage, file transfers, and copying and pasting.

User attention words

The following user attention words might appear in this document. Each word implies a particular level of observation or action as described below:

Note: Provides information that may be of interest or help but is not critical to the use of the product.

IMPORTANT! Provides information that is necessary for proper instrument operation or accurate chemistry kit use.

Safety alert words appear in this document with an open triangle figure that contains a hazard symbol. These hazard symbols are identical to the hazard symbols that are affixed to the instrument.

For descriptions of the safety symbols, see Appendix I, “Safety”.

Symbols on this instrument

Symbols may be found on the instrument to warn against potential hazards or convey important safety information. In this document, the symbol is used along with the user attention words to highlight important safety information. The following table gives the meaning of these symbols.

Symbol	English	Français
	Caution, risk of danger Consult the manual for further safety information.	Attention, risque de danger Consulter le manuel pour d'autres renseignements de sécurité.

Contents of this manual

This guide is divided into the following chapters and appendixes:

Chapter/appendix	Content
Chapter 1, “Getting started”	Introduces the QuantStudio™ 6 and 7 Flex Systems, including descriptions of all related hardware and software.
Chapter 2, “Calibrate the instrument”	Describes how to maintain a QuantStudio™ 6 or 7 Flex Real-Time PCR System, including calibration and performance verification.
Appendix A, “Manual instrument operation”	Describes how to operate the QuantStudio™ 6 and 7 Flex Systems manually using the touchscreen interface.
Appendix B, “Maintenance”	Describes how to replace the user-serviceable parts of the QuantStudio™ 6 and 7 Flex Systems and how to resolve infrequent problems that can occur during normal use.
Appendix C, “Networking”	Describes how to install the QuantStudio™ 6 and 7 Flex Systems to a local area network for remote monitoring and control.

(continued)

Chapter/appendix	Content
Appendix D, "Power on or off, store, and move"	Describes how to store, move, and reinstall the components of the QuantStudio™ 6 and 7 Flex Systems.
Appendix E, "Security, audit, and electronic signature"	Describes how to configure the security, audit, and electronic signature functions of the QuantStudio™ Real-Time PCR Software.
Appendix F, "Calibration consumable preparation"	Describes how to prepare consumables for custom dye calibration.
Appendix G, "Parts and materials"	Describes how to order parts, accessories, and consumables for the QuantStudio™ 6 and 7 Flex Systems.
Appendix H, "Instrument specification and layout"	Describes the QuantStudio™ 6 and 7 Flex System specifications, requirements, layout, and connections.



Getting started

- Differences between the QuantStudio™ 6 and 7 Flex Real-Time PCR Systems 13
- About the QuantStudio™ 6 and 7 Flex Real-Time PCR Systems 13
- Instrument hardware 16
- Instrument software 20
- Instrument consumables 22
- Interchangeable sample blocks, heated covers, and plate retainers 23

Differences between the QuantStudio™ 6 and 7 Flex Real-Time PCR Systems

The following table displays the differences between the QuantStudio™ 6 Flex System and the QuantStudio™ 7 Flex System.

QuantStudio™ 6 Flex System	QuantStudio™ 7 Flex System
Does not support the TaqMan™ Array Card block	Supports the TaqMan™ Array Card block
Features a coupled five-color filter set	Features a decoupled six-by-six-color filter set

About the QuantStudio™ 6 and 7 Flex Real-Time PCR Systems

The QuantStudio™ 6 and 7 Flex Real-Time PCR Systems use fluorescent-based polymerase chain reaction (PCR) reagents to provide:

- Quantitative research detection of target nucleic acid sequences (targets) using real-time analysis.
- Qualitative research detection of targets using post-PCR (endpoint) analysis.
- Qualitative analysis of the PCR product (achieved by melt curve analysis that occurs post-PCR).



Data collection

The QuantStudio™ 6 and 7 Flex Systems collect raw fluorescence data at different points during a PCR, depending on the type of run that the QuantStudio™ 6 and 7 Flex Systems perform:

Table 1

Run type		Data collection point
Real-time runs	Standard curve	The QuantStudio™ 6 and 7 Flex Systems collect data following each extension step of the PCR.
	Relative standard curve	
	Comparative C _t ($\Delta\Delta C_t$)	
	Melting curve	
Post-PCR (endpoint) runs	Genotyping	The QuantStudio™ 6 and 7 Flex Systems collect data: <ol style="list-style-type: none"> 1. Before the PCR. (For presence/absence experiments, data collection before the PCR is optional, but recommended.) 2. (Optional) During the PCR. The QuantStudio™ 6 and 7 Flex System can collect data during the run (real-time); collecting data during the run can be helpful for troubleshooting. 3. After the PCR.
	Presence/absence	

The instrument collects raw fluorescence data following each extension step of the PCR. A data collection point, or read, on the QuantStudio™ 6 and 7 Flex System consists of three phases:

- 1. Excitation:** The instrument illuminates all wells of the plate or array card, within the instrument, exciting the fluorophores in each reaction.
- 2. Emission:** The instrument optics collect the residual fluorescence emitted from the wells of the plate or array card. The resulting image collected by the device consists only of light that corresponds to the range of emission wavelengths.
- 3. Collection:** The instrument assembles a digital representation of the residual fluorescence collected over a fixed time interval. The software stores the raw fluorescent image for analysis.

After a run, the software uses calibration data (ROI, background, uniformity, dye, and normalization) to determine the location and intensity of the fluorescent signals in each read, the dye associated with each fluorescent signal, and the significance of the signal.

Instrument filters and supported dyes

System dyes

The QuantStudio™ 6 Flex System features a coupled five-color filter set while the QuantStudio™ 7 Flex System features a decoupled six-by-six-color filter set that supports the dyes shown in the following table. For more information about the spectral dye calibration kits available for the QuantStudio™ 6 and 7 Flex Systems, contact Thermo Fisher Scientific.

Filter set	Color	Filter wavelength ^[1]		Supported dye
		Excitation	Emission	
x1-m1	Blue	470 ± 15 nm	520 ± 15 nm	FAM™ dye and SYBR™ Green dye
x2-m2	Green	520 ± 10 nm	558 ± 12 nm	JOE™ dye, HEX™ dye, TET™ dye, and VIC™ dye ^[2]
x3-m3	Yellow	549.5 ± 10 nm	586.5 ± 10 nm	Cy™ 3 dye, NED™ dye, and TAMRA™ dye
x4-m4	Orange	580 ± 10 nm	623 ± 14 nm	ROX™ dye and Texas Red™ dye
x5-m5	Red	640 ± 10 nm	682 ± 14 nm	Cy™ 5 dye and LIZ™ dye ^[2]
x6-m6 ^[3]	Deep red	662 ± 10 nm	711 ± 12 nm	None ^[4]

^[1] The central wavelengths are the optimized wavelengths.

^[2] The HEX™ dye, TET™ dye, and LIZ™ dye from Thermo Fisher Scientific fall within the emission wavelength range of the system, therefore they can be added and adapted for use in experiments on the system. To add any of these dyes to the Dye Library, perform a custom dye calibration. For more information, see Appendix F, "Calibration consumable preparation".

^[3] QuantStudio™ 7 Flex System only.

^[4] This filter set currently does not support any dyes supplied by Thermo Fisher Scientific.

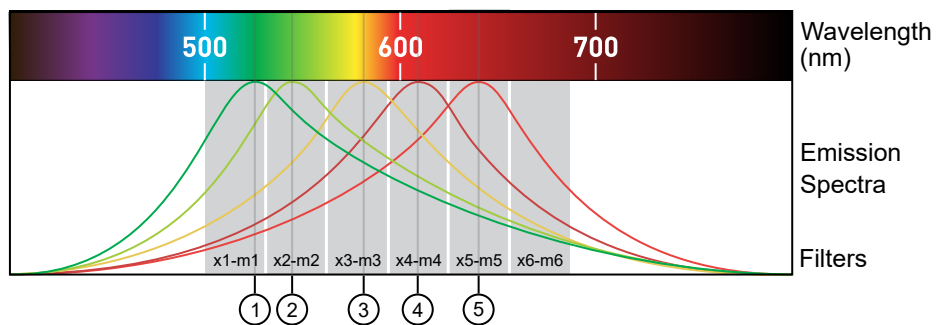

- ① FAM™ dye and SYBR™ Green
- ② VIC™ dye and JOE™ dye
- ③ Cy™ 3 dye, NED™ dye, and TAMRA™ dye
- ④ ROX™ dye and Texas Red™ dye
- ⑤ Cy™ 5 dye

Custom dyes

The QuantStudio™ 6 and 7 Flex Systems can run assays designed with custom dyes (dyes not supplied by Thermo Fisher Scientific) that are excited between 455 to 672 nm and read between 505 to 723 nm. To add a custom dye to the Dye Library, perform a custom dye calibration. For more information, see Appendix F, “Calibration consumable preparation”.

Instrument hardware

The QuantStudio™ 6 and 7 Flex Systems consist of the components shown in the following figure and described in the subsequent table.

Front

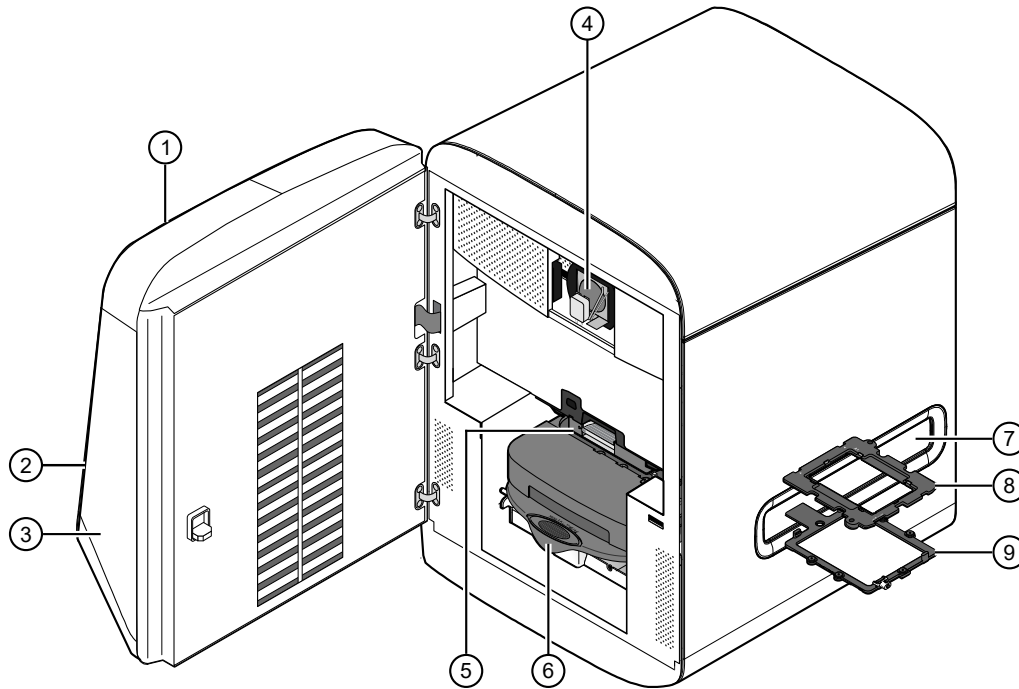

	Component	Description
1	Touchscreen	Provides access to the instrument functions. Can be used to run experiment, transfer data, and operate the instrument functions without the use of the computer.
2	USB ports	Provide USB communication with the instrument. Can be used to transfer data to and from the instrument. Note: If multiple USB drives are plugged into the instrument, the instrument mounts only the first drive that is installed, regardless of the USB port used.
3	Access door	Provides access to the instrument lamp, the heated cover, and the sample block.
4	Lamp	Illuminates the plate or array card during a run.
5	Heated cover	Covers the plate or array card during a run to prevent condensation and leakage through the cover.
6	Sample block	Heats the plate or array card during a run.
7	Side door	Opens to allow extension of the tray arm.
8	Plate adapter	Secures the plate or array card to the tray arm.
9	Tray arm	Conveys the plate or array card to and from the sample block in the interior of the instrument.

Rear

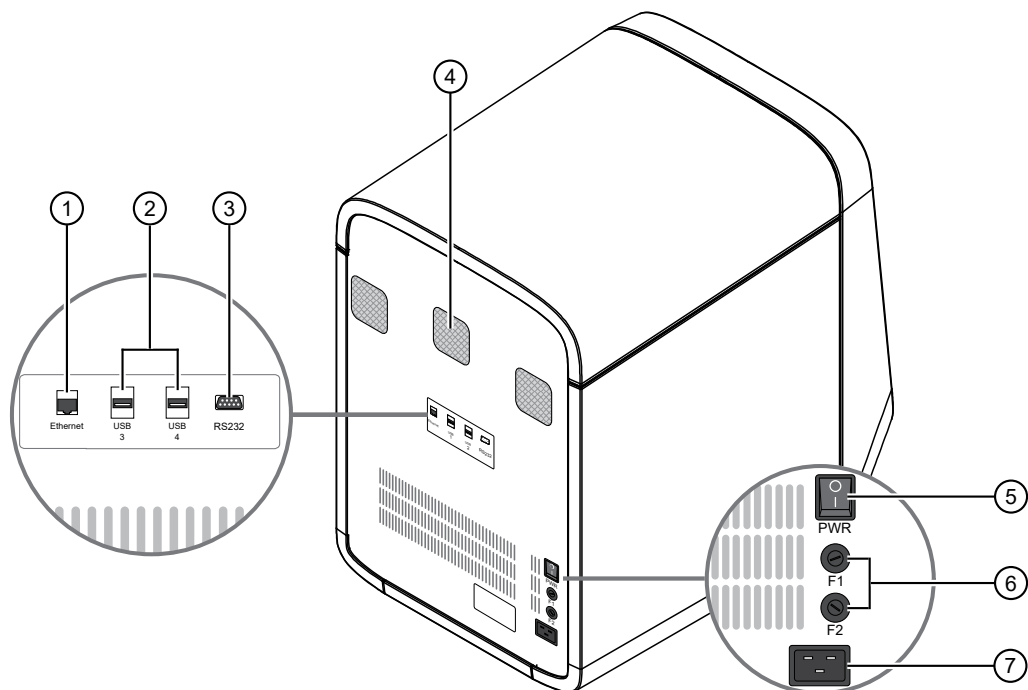

	Component	Description
1	Ethernet port	An RJ45 port that provides Ethernet (gigabit) communication with the instrument. ^[1]
2	USB ports	Provide USB communication with the instrument. USB ports can be used to transfer data from the instrument. Note: If multiple USB drives are plugged into the instrument, the instrument mounts only the first drive that is installed, regardless of the USB port used.
3	RS232 port	Provides serial communication between the instrument and the computer. IMPORTANT! The serial port is for Thermo Fisher Scientific use only.
4	Instrument fans	Cool the interior of the instrument. IMPORTANT! The fans must be unobstructed to ensure adequate cooling and proper function of the instrument.
5	On/Off switch	Power switch for the instrument, where the states are on () or off (O).

(continued)

	Component	Description
6	Fuse cover	Dual 12.5A, Time-Lag T, 250 VAC, 5 × 20-mm electrical fuses that protect the instrument from excessive electrical current. For AU/NZ only - 6.3A, Time-Lag, 250VAC, 5 × 20-mm.
7	Power port	The 100–240 VAC port that provides power to the instrument.

^[1] Use the Ethernet cable supplied with the instrument to connect the instrument (Ethernet port) to the network interface card in the computer.

Barcode scanner

The QuantStudio™ 6 and 7 Flex Systems include an optional Handheld Barcode Scanner (Cat. No. 4453271) that you can purchase to assist you with data entry. The barcode scanner uses a 670 nm Class II laser to scan plates or array cards (for only the QuantStudio™ 7 Flex System) and it is capable of reading Code 128 (alphanumeric), which supports 128 ASCII character barcodes.



WARNING! LASER. Exposure to direct or reflected laser light can burn the retina and leave permanent blind spots. Never look into the laser beam. Remove jewelry and anything else that can reflect the beam into your eyes. Protect others from exposure to the beam.

The optional hand-held barcode scanner functions as an extension of the keyboard. You can use the scanner to scan barcodes into the instrument software.

To scan a barcode using the hand-held barcode scanner:

1. Select the field in the instrument software where you want to enter the barcode.
2. Hold the hand-held barcode scanner 20–30 cm away from a plate or array card and aim at the center of the barcode, then press the trigger. Slowly move the scanning beam across the barcode until the scanner emits a high-pitched tone.

When the scanner scans a barcode, it automatically:

- Transmits the alphanumeric equivalent of the barcode to the instrument software. The software enters the barcode text wherever the cursor is active.
- Transmits a carriage-return character (the equivalent of pressing the Enter key).

For more information on the hand-held barcode scanner, see the user documentation shipped with the barcode scanner.

Electrical protective devices

We recommend several protective devices to protect the instrument in environments with large voltage and power fluctuations.

Power line regulator

We recommend the use of a 1.5-kVA power line regulator in areas where the supplied power fluctuates in excess of $\pm 10\%$ of the normal voltage. Power fluctuations can adversely affect the function of the instrument and the computer.

Note: A power line regulator monitors the input current and adjusts the power supplied to the instrument or computer. It does not protect against a power surge or failure.

Uninterruptible power supply (UPS)

We recommend the use of a 1.5-kVA uninterruptible power supply (UPS), especially in areas prone to power failure. Power failures and other events that abruptly terminate the function of the instrument and the computer can corrupt data and possibly damage the system.



WARNING! PHYSICAL INJURY HAZARD. Do not attempt to lift the UPS unit without assistance (minimum of two people). Improper lifting can cause painful and permanent back injury. Refer to the UPS manufacturer user guide for more information.

IMPORTANT! UPSs provide power for a limited time. They are meant to delay the effects of a power outage, not to serve as replacement power sources. In the event of a power loss, power off the instrument and the computer, unless you expect to regain power within the battery life of the UPS.

Surge protector

We recommend the use of a 10-kVA surge protector (line conditioner) in areas with frequent electrical storms or near devices that are electrically noisy, such as refrigerators, air conditioners, or centrifuges. Short-duration, high-voltage power fluctuations can abruptly terminate the function of, and thereby damage the components of, the computer and the instrument.

Note: A dedicated line and ground between the instrument/computer and the building's main electrical service can also prevent problems caused by power fluctuations.

Instrument software

The QuantStudio™ 6 and 7 Flex Systems include a suite of software applications that can be used to calibrate, run, automate, and integrate the instrument into a laboratory workflow. The installation of the software contains the components described in the following sections; however, additional software may be available for the QuantStudio™ 6 and 7 Flex Systems. Go to [thermofisher.com/qpcsoftware](https://www.thermofisher.com/qpcsoftware) for a complete list of compatible software, and for updates and patches for the system software and firmware.

Computer requirements

The requirements for the computer used to operate the QuantStudio™ 6 and 7 Flex Systems can vary depending on the version of the QuantStudio™ Real-Time PCR Software that you are running. To determine the computer requirements for your system, check the software release notes at thermofisher.com/qpcrsoftware. The release notes are on the same page as the link for the software download.

Software installation

The default installation of the instrument partitions the computer hard drive to create the logical drives as explained below.

Drive	Software	Description
C drive	Microsoft™ Windows™ OS ^[1]	Operating system files.
C or D drive	QuantStudio™ Real-Time PCR Software	Used to calibrate and perform experiments on the QuantStudio™ 6 and 7 Flex System. Stores the installation files, application data files, and user files (experiments, exports, and imports).
	QuantStudio™ 6 and 7 Flex System Command Line Utility	Used to automate the creation of new experiments and the export of existing experiments.

^[1] We recommend that you do not install programs to the C drive.

Third-party software

Before you install third-party software to the computer running the QuantStudio™ Real-Time PCR Software, confirm that the software will not restrict Ethernet communication or interfere with the software operation.

Third-party software

1. Install the third-party software to the computer that contains the QuantStudio™ Real-Time PCR Software.
2. Perform several test experiments using plates that do not contain reagents.

Note: The goal of the test experiments is to run plates under conditions that match normal instrument operation. Therefore, the characteristics of the test experiments (plate layout and run method) must closely resemble your actual experiments.

3. Confirm that the QuantStudio™ 6 and 7 Flex Systems perform each test experiment without producing errors.

If the systems perform the tests successfully, perform experiments normally. If the systems encounter errors during the test runs, the software may not be compatible with the QuantStudio™ Real-Time PCR Software.

Instrument consumables

The QuantStudio™ 6 and 7 Flex Systems support a series of specialized consumables through interchangeable sample blocks. Use the consumables appropriate for the sample block of your QuantStudio™ 6 or 7 Flex Systems.

Note: The QuantStudio™ 6 Flex System does not support the Array Card block.

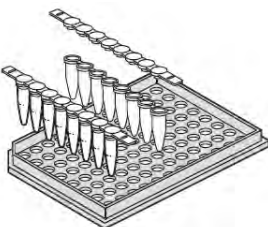
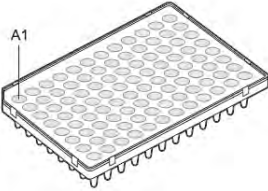
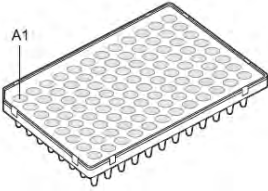
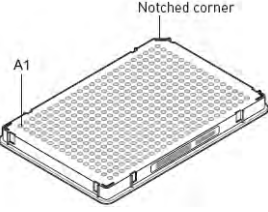
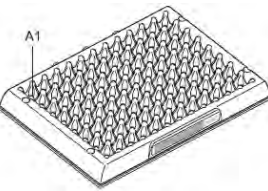

WARNING! Use the flat caps for 0.2 mL tubes and 0.1 mL tubes. Rounded caps can damage the heated cover.

Sample block		Consumable	Reaction volume
96-well plate, 0.2 mL		<ul style="list-style-type: none"> • MicroAmp™ Optical 8-Cap Strip • MicroAmp™ 8-Tube Strips (0.2-mL) • MicroAmp™ Reaction Tubes without Caps (0.2-mL) • MicroAmp™ 96-Well Tray/Retainer Set 	100 µL
		<ul style="list-style-type: none"> • MicroAmp™ Optical Adhesive Film • MicroAmp™ Optical 96-Well Reaction Plate with Bar Code 	100 µL
96-well plate, 0.1 mL		<ul style="list-style-type: none"> • MicroAmp™ Optical Adhesive Film • MicroAmp™ Optical 96-Well Fast Reaction Plate with Bar Code 	50 µL
384-well plate		<ul style="list-style-type: none"> • MicroAmp™ Optical Adhesive Film • MicroAmp™ Optical 384-Well Reaction Plate with Bar Code 	20 µL
TaqMan™ Array Card ^[1]		TaqMan™ Array Card	1 µL

^[1] QuantStudio™ 7 Flex System only.

Interchangeable sample blocks, heated covers, and plate retainers

The QuantStudio™ 6 and 7 Flex Systems feature a set of interchangeable sample blocks, heated covers, and plate retainers that allow the instruments to support multiple consumable formats. All of the hardware is user-installable. Replacement can be done without the need for recalibration of the instrument, provided that the calibrations for the new format have not expired. See Appendix B, “Maintenance” for more information about changing the sample block, heated cover, and plate retainer.



Calibrate the instrument

- Calibration overview 25
- Enable or change the calibration reminders 29
- Guidelines for preparing calibration plates and array cards 32
- Preparing array cards for instrument calibration 33
- ROI calibration 37
- Background calibration 42
- Uniformity calibration 46
- Dye calibration 49
- Normalization calibration 55
- Verify the instrument performance 59
- Troubleshooting 71

IMPORTANT! Perform the procedures for preparing array cards only if you are verifying the performance of a QuantStudio™ 7 Flex System with an array card sample block. The QuantStudio™ 6 Flex System does not support the array card sample block.

Calibration overview

Calibration and maintenance schedule

The QuantStudio™ 6 and 7 Flex Systems require regular calibration and maintenance for proper operation. To ensure proper operation of your instrument, perform weekly, monthly, and semiannual maintenance as indicated in the following table.

IMPORTANT! Perform calibrations and run experiments under the environmental conditions specified in Appendix H, “Instrument specification and layout”. Exposure to extreme temperatures can have adverse effects on the run results, as well as shortening the life span of the instrument components.

IMPORTANT! Do not use organic solvents to clean the QuantStudio™ 6 and 7 Flex Systems.

Frequency	User-performed maintenance task
Weekly	Check the computer disk space. If necessary, archive or back up your experiment files and instrument settings.
	Power off the computer that controls the instrument, then power on the computer after 30 seconds.
	Clean the surface of the instrument with a lint-free cloth.
Monthly	Perform a background calibration. ^[1]
	Run disk cleanup and disk defragmentation.
	Perform an instrument self test.
Semi-annually (every 6 months)	Perform an ROI calibration.
	Perform a background calibration. ^[1]
	Perform a uniformity calibration.
	Perform a dye calibration.
	Perform a normalization calibration.
As needed	Perform an RNase P instrument verification run.
	Replace the instrument lamp. ^[2]

^[1] You can perform a background calibration to check for contamination.

^[2] After replacing the instrument lamp, perform all calibrations and an RNase P instrument verification run.

Note: Normalization calibration is required for all block types with QuantStudio™ Real-Time PCR Software v1.3.

Planned maintenance

The instrument requires regular planned maintenance by Thermo Fisher Scientific service personnel to ensure that the instrument is operating within the installation specification. The planned maintenance service can help you maximize your productivity by minimizing downtime, lowering the cost of ownership by addressing potential problems before they manifest (lost data, samples, or reagents), and increasing the quality of your results by maintaining your instrument at optimal performance. For more information, contact your Thermo Fisher Scientific sales representative.

About maintenance reminders

The QuantStudio™ Real-Time PCR Software features an automated notification system that alerts you of required calibrations. The feature will also prevent you from operating an instrument that is out of calibration. For more information on setting the maintenance reminders, see “Enable or change the calibration reminders” on page 29.

Calibration workflow

Whether you are performing all calibrations or just a subset, perform calibrations for the QuantStudio™ 6 and 7 Flex Systems in the following sequence.

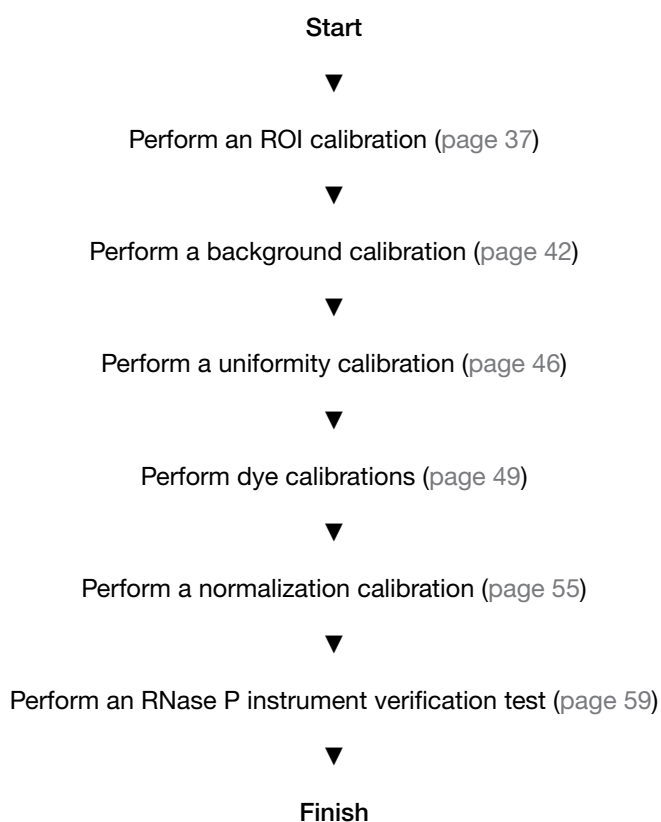

Note: Normalization calibration is required for all block types with QuantStudio™ Real-Time PCR Software v1.3.

View the calibration status of an instrument

You can use the Instrument Console of the QuantStudio™ Real-Time PCR Software to view the calibration status of an instrument.

1. In the QuantStudio™ Real-Time PCR Software **Home** tab, click  **Instrument Console**.
2. From the **Instrument Console** open the **Instrument Manager**.
 - a. Select your instrument icon from the **My Instruments** group.
 - b. Click **Manage Instrument**.

Note: If the **Manage Instrument** option is inactive, connect your instrument to the **My Instruments** group.

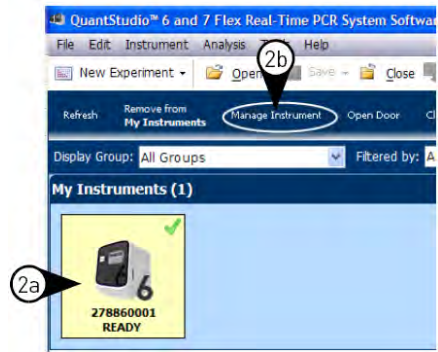

3. From the **Instrument Manager**, click **Monitor**, then click **Information** to open the instrument monitor.

The instrument monitor screen displays the following information:

- a. The Instrument type (the QuantStudio™ 6 Flex System or the QuantStudio™ 7 Flex System)
- b. The status of all calibrations, including the date and time of each calibration
- c. The maintenance status of the instrument
- d. The properties of the instrument

278860001 (384-Well Block)
QuantStudio™ 6 Flex System
READY

Export Instrument Details Print Calibration Log Print Maintenance Summary

Calibration Status

Type	Last Run	By	Status
ROI	06-20-2013 09:49:16 SGT	GUEST	Current
Background	06-20-2013 09:57:23 SGT	GUEST	Current
Uniformity	06-20-2013 10:04:14 SGT	GUEST	Current
Dye			
FAM	06-20-2013 10:11:09 SGT	GUEST	Current
VIC	06-20-2013 10:18:06 SGT	GUEST	Current
ROX	06-20-2013 10:27:22 SGT	GUEST	Current
SYBR	06-20-2013 10:37:27 SGT	GUEST	Current
NED	06-20-2013 10:53:57 SGT	GUEST	Current
TAMRA	06-20-2013 10:44:41 SGT	GUEST	Current
MELTDOCTOR	06-21-2013 14:40:54 SGT	GUEST	Current
Normalization			
FAM/ROX	06-20-2013 11:01:35 SGT	GUEST	Current
VIC/ROX	06-20-2013 11:08:56 SGT	GUEST	Current
HRM			
RNase P	06-21-2013 09:26:48 SGT	GUEST	Current

Maintenance Info

Property	Value
Lamp Life	46 hours
Total Cycles for Block	3,856
Total Degrees for Block	121,250

Instrument Properties

Property	Value
Instrument Label	ruo
Serial Number	278860001
Instrument Firmware Version	1.0.3
IP Address	172.28.1.105
Block Type	384-Well Block
Controller Firmware Version	1.0.2
Optics Firmware Version	24
Thermal Block Firmware Version	20
Heated Cover Firmware Version	10

Note: While viewing the **Monitor** screen, you can generate reports of the calibration history and status for the instrument. The following options are available from the **Instrument Manager**:

- **Print Calibration Log**—Prints the calibration history of the instrument.
- **Print Maintenance Summary**—Prints a summary of the current instrument calibrations.

Note: The details for an instrument in the **My Preferred** list can be exported even if the network connection has been interrupted. The exported details from the disconnected instrument would contain the data most recently downloaded from the instrument before the interruption.

Enable or change the calibration reminders

The calibration reminder settings allow you to configure the QuantStudio™ Real-Time PCR Software to alert you by email when the QuantStudio™ 6 or 7 Flex Real-Time PCR System requires calibration. The notifications settings feature is optional, and it does not affect instrument performance.

IMPORTANT! The calibration reminders feature requires a connection between the QuantStudio™ 6 or 7 Flex Real-Time PCR System computer and a computer network. If you choose to set up the feature as described below, ensure that your network has appropriate security measures in place to protect data from threats such as computer viruses.

IMPORTANT! The QuantStudio™ Real-Time PCR Software transmits emails only while the QuantStudio™ 6 or 7 Flex Real-Time PCR System is monitored. If the network connection is interrupted, the software will stop transmitting updates.

Requirements to email calibration reminders

The QuantStudio™ Real-Time PCR Software requires access to a Simple Mail Transfer Protocol (SMTP) server to email calibration reminders. Contact your systems administrator or information technology department for the following information:

- Network address of an SMTP server.
- A user name and password for the server, if required for access.
- The Secure Sockets Layer (SSL) setting of the server (on or off).

Define the mail server settings

1. In the QuantStudio™ Real-Time PCR Software, select **Tools ▶ Preferences**.
2. From the **Preferences** dialog box, select the **SMTP Settings** tab.
3. Define the settings for the SMTP server:
 - a. From the **Outgoing Mail Server (SMTP)** field, enter the network address of a Simple Mail Transfer Protocol (SMTP) server.

Optionally, you can specify the transmission control protocol (TCP) port for the server by appending the port number to the server name, separating the two using a colon (:).

For example: *smtp.mycompany.com:2023*

Note: If a TCP port is not specified, the software uses the default port number (25).

- b. Select **Encryption Required** if the mail server has SSL enabled.
- c. Select **Authentication Required** if the mail server requires a user name and password.

- d. If the mail server requires authentication, enter the user name and password provided by your systems administrator.

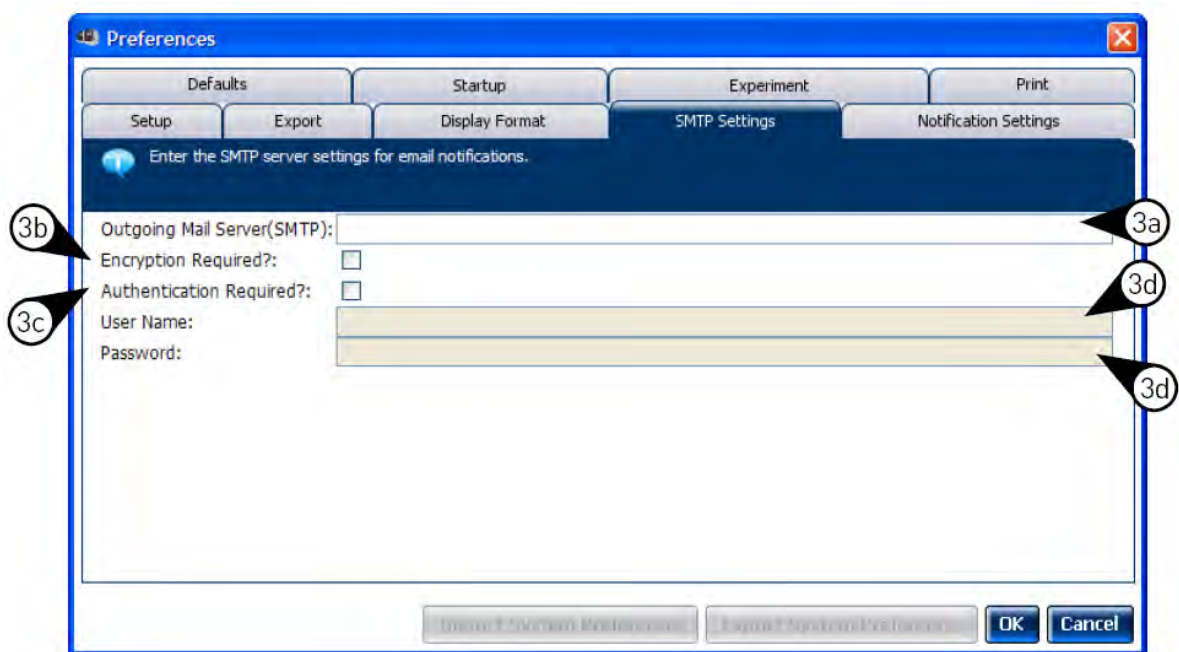

4. Click **OK**.
5. Test the mail server settings:
- In the Home tab of the QuantStudio™ Real-Time PCR Software, select any experiment in the **Set Up** panel, then click **Set Up** to create a new experiment.
 - In the experiment document, click  **Run** in the **Experiment Menu**, then click **Notification Setting** to view the notification settings for the experiment.
 - In the **Notification Settings** of the experiment document, select **Yes** to enable the Enable Notifications setting.
 - From the **Enter e-mail addresses for notifications** field, enter the email address that you want to receive the test emails.

- e. Click **Test Configuration** to test the mail server settings.

Confirm that the email account you specified in substep 5d received the test messages from the QuantStudio™ Real-Time PCR Software. If not, consult your network administrator to confirm that the mail server settings are defined correctly.

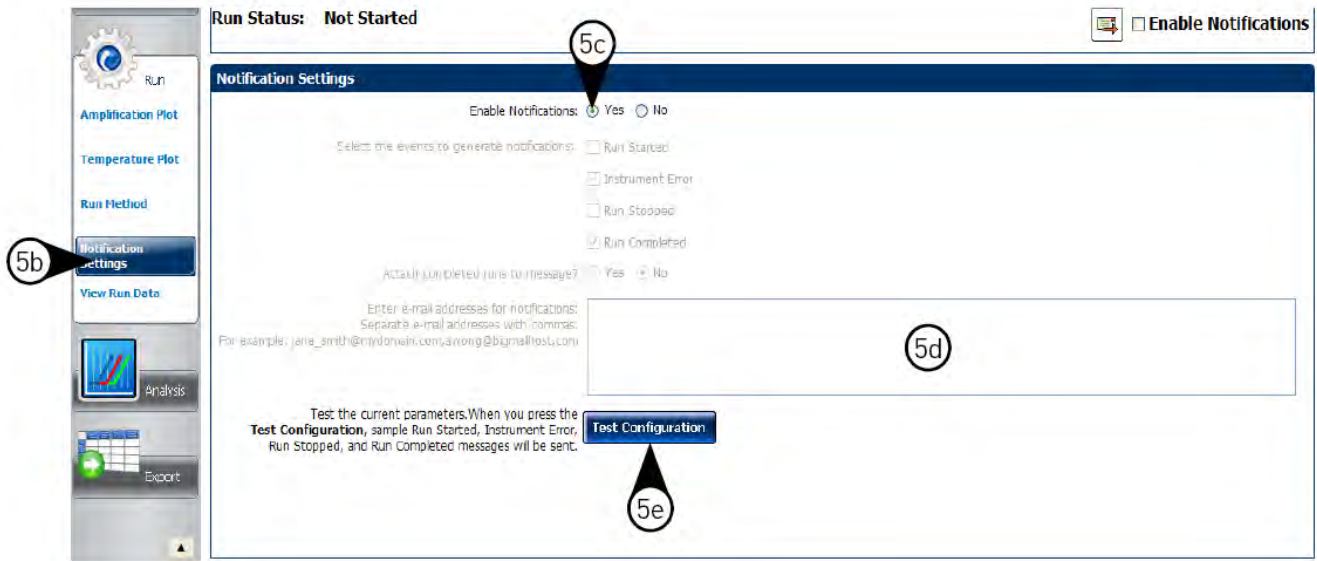

Modify the notification settings for a monitored instrument

1. Open the **Calibration Reminders** screen for the QuantStudio™ 6 or 7 Flex Real-Time PCR System:
 - a. In the QuantStudio™ Real-Time PCR Software **Home** tab, click **Instrument Console**.
 - b. In the **Instrument Console**, select the icon for your instrument, then click **Manage Instrument**.

Note: If the **Manage Instrument** button is inactive, add your instrument to the **My Instruments** group.

- c. In the **Instrument Manager**, click **Maintenance**, then click **Calibration Reminders**.
2. In the **Calibration Reminders Setting** table, configure the notification settings for the calibrations in interest. For each calibration that you want to monitor:
 - a. In the **Send a Reminder** column, select the check box to configure the QuantStudio™ Real-Time PCR Software to email a reminder to perform the calibration.
 - b. In the **Reminder Interval** column, enter the number of days before the calibration expires that the software should send a reminder email.
3. In the **Enter e-mail addresses for notifications** field, enter the email address(es) that you want to receive notifications. Separate multiple email addresses with commas (,).
4. Click **Apply** to change the notification settings.

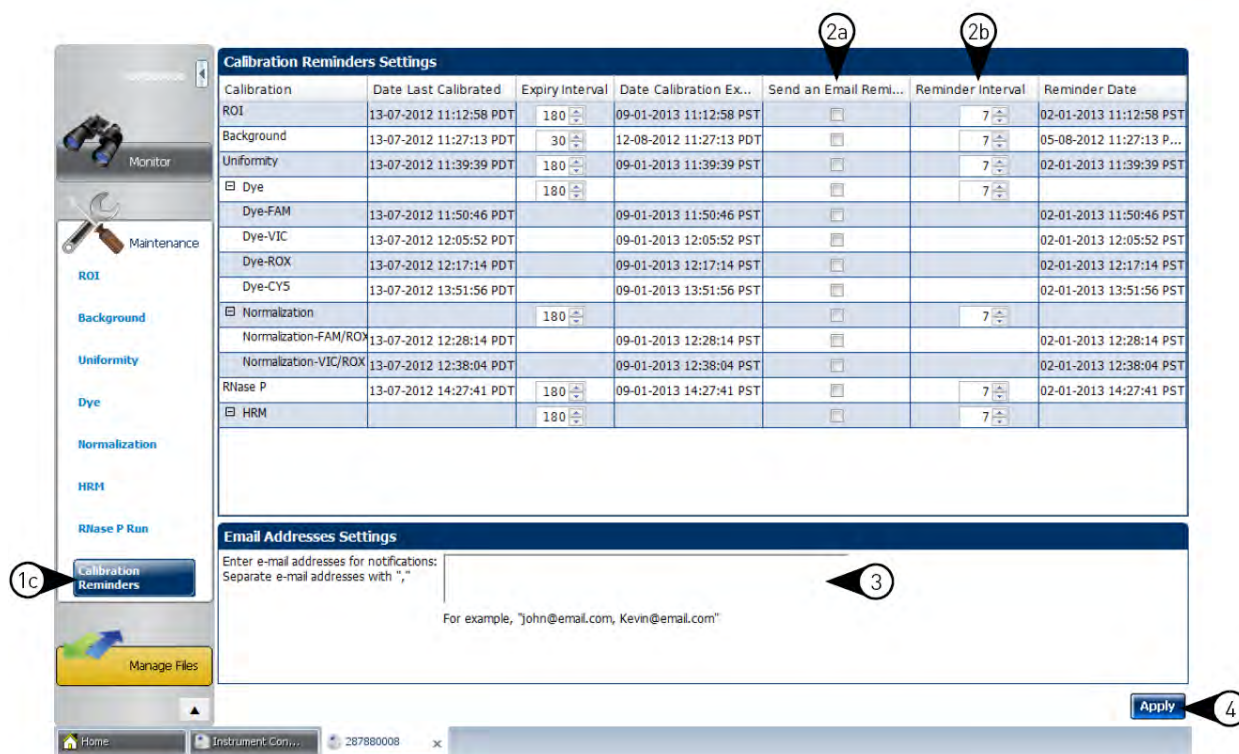

Guidelines for preparing calibration plates and array cards

Observe the following guidelines when preparing calibration plates and array cards:

- Wear appropriate protective eyewear, clothing, and gloves.
- Prepare and run calibration plates and array cards within the recommended time limits listed below.

Consumable	Time to thaw	After thawed, run within...
All 96-/384-well calibration consumables ^[1]	30 minutes	120 minutes
All array card calibration consumables ^[2]	30 minutes	120 minutes
RNase P plate (96-/384-well)	5 minutes	30 minutes
RNase P array card ^[3]	15 minutes	60 minutes

^[1] All 96-well plates and 384-well plates used in the calibration of the instrument (ROI, background, uniformity, dye, and normalization).

^[2] All array cards used in the calibration of the QuantStudio™ 7 Flex System only (ROI, background, uniformity, dye, and normalization).

^[3] For use with QuantStudio™ 7 Flex System only.

- *(Plates only)* Do not discard the packaging for the calibration plates. Each plate can be used to calibrate the QuantStudio™ 6 and 7 Flex Systems 3 times for up to 6 months if it is stored in its packing sleeve.
- Store calibration plates or array cards in a dark place until you are ready to use them. The fluorescent dyes in the wells of calibration consumables are photosensitive. Prolonged exposure to light can diminish the fluorescence of the dyes.

- Do not allow the bottoms of the plates or array cards to become dirty. Fluids and other contaminants that adhere to the bottoms of the consumables can contaminate the sample block and cause an abnormally high background signal.
- Confirm that your centrifuge is clean. Before centrifugation, wipe down the bucket(s) using a tissue.
- Vortex and centrifuge all calibration plates to ensure complete mixing and that all reagents are contained at the bottom of the wells. The calibration plates must be well mixed and centrifuged before use.

Preparing array cards for instrument calibration

IMPORTANT! Perform the following procedure only if you are verifying the performance of a QuantStudio™ 7 Flex System with an array card sample block. The QuantStudio™ 6 Flex System does not support the array card sample block.

Required materials

- ViiA™ 7 Array Card Spectral Calibration Kit
 - Empty TaqMan™ Array Cards
 - FAM™ dye
 - VIC™ dye
 - ROX™ dye
 - ROI dye mix
 - Background buffer
 - FAM™/ROX™ dye
 - VIC™/ROX™ dye
- TaqMan™ Array Card Sealer
- Centrifuge with array card buckets and array card carrier clips
- Permanent marker or pen
- Pipettor, 200- μ L (with pipette tips)
- Powder-free gloves
- Safety glasses

Fill the calibration TaqMan™ Array Cards

IMPORTANT! Wear powder-free gloves while creating the calibration array cards.

This procedure explains how to create *all* of the array cards required to calibrate the QuantStudio™ 7 Flex System, but not all of them are required for a monthly maintenance. Before preparing array cards for calibration, determine which calibrations are required (see “Calibration and maintenance schedule” on page 25).

Note: For more information on the array card loading procedure, contact Technical Support.

1. Remove the tubes of calibration solutions from the freezer, allow them to thaw, then vortex the tubes to mix the contents well.
2. Remove the array cards from their box and place them on a clean, dry surface.
3. Mark the side of the empty array cards with:
Background, FAM™, ROI, ROX™, VIC™, FAM™/ROX™,
and VIC™/ROX™.

4. For each array card, pipet 100 µL of the appropriate calibration solution into each of the eight reservoirs in the array card:

- a. Place the array card on a lab bench, with the foil side down.
- b. Load 100 µL of the calibration solution into a pipette.
- c. Hold the pipette in an angled position (approximately 45 degrees) and place the tip into the fill port. The fill port is the larger of the two holes on the left side of the fill reservoir.

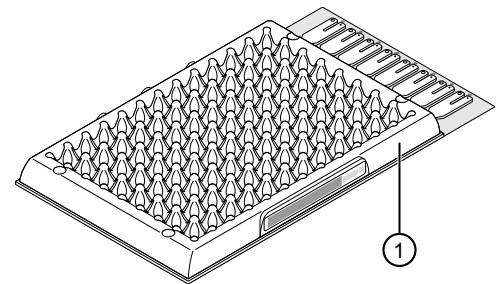

① Mark here

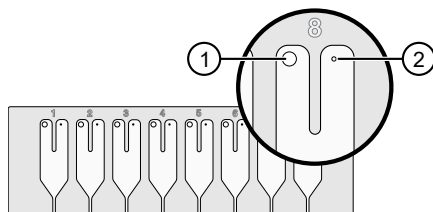

- ① Fill port
- ② Vent port

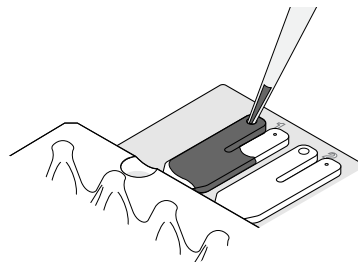

- d. Dispense the fluid so that it sweeps in and around the fill reservoir toward the vent port.

Pipet the entire 100 μ L into the fill reservoir, but *do not* go past the first stop of pipettor plunger or you may blow the solution out of the port.

IMPORTANT! Do not allow the tip to contact and possibly damage the coated foil beneath the fill port.

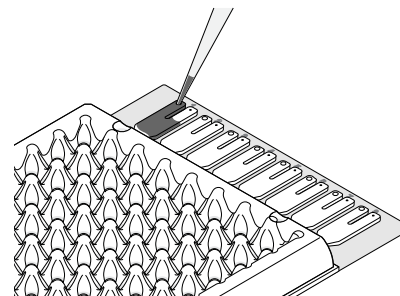

5. Repeat step 4 to fill the remaining array card with the appropriate calibration reagents.
6. Centrifuge the array card(s):
- Place the filled array card(s) into a centrifuge array card carrier clip and place empty array cards in the remaining slots. Confirm that the labels on the buckets and clips are oriented in the same direction.
 - Place the filled carrier clips into the centrifuge buckets. Make sure that the array card fill reservoirs and bucket and clip labels face outward when loaded into the centrifuge.

IMPORTANT! You must run the centrifuge with all four buckets in place and each of the two carriers filled with array cards. Place empty array cards into unfilled slots.

IMPORTANT! Balance the loads in opposite buckets in the centrifuge.

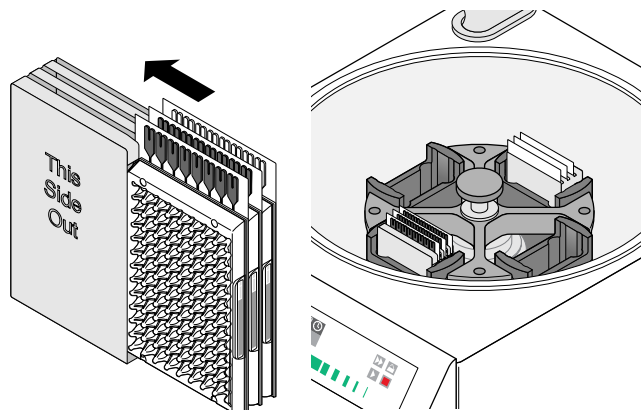

- Close the centrifuge cover, then spin the array card(s) for 1 minute at 1200 rpm.
- When the run is finished, stop the centrifuge, then spin the array card(s) again for 1 minute at 1200 rpm.

IMPORTANT! Do not try to save time by doing one spin for 2 minutes. The two sets of ramps are important for a good fill into the array card.

7. When the second run is finished, open the centrifuge and check that the fluid levels in the reservoirs of each array card have decreased by the same amount. Also, check all wells for bubbles and note the locations as possible problems.

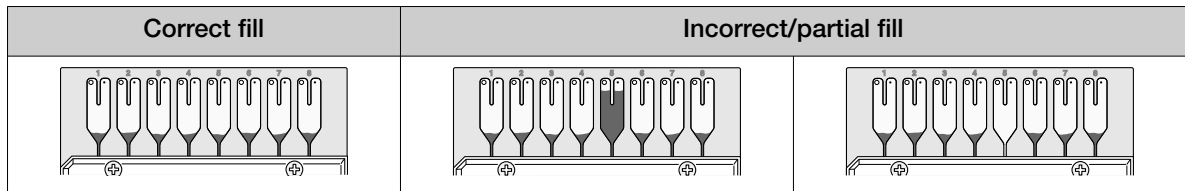

If necessary, centrifuge the array cards for an additional minute to fill any unfilled wells. Do not exceed three 1-minute runs or centrifuge the array card for longer than 1 minute at a time.

8. Seal the array card(s):

- a. With the carriage (roller assembly) of the TaqMan™ Array Card Sealer in the Start position, place a filled array card into the fixture with the foil side up so that the fill reservoirs are the farthest away from the carriage.

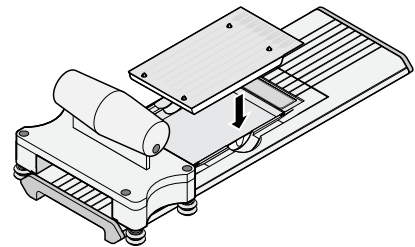

- b. Press down on all four corners of the array card to ensure that it is fully seated within the fixture.

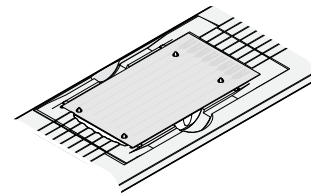

- c. Use the two alignment pins in the fixture to position the array card correctly.

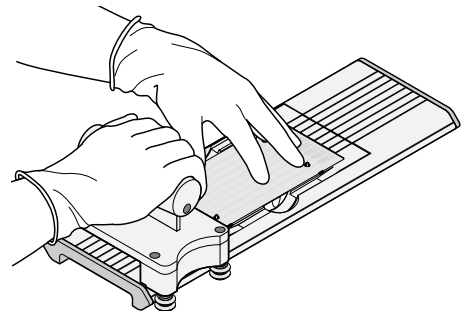

- d. Seal the array card by running the carriage slowly over it. Run the carriage over the array card in one direction only. Do not apply downward force on the carriage as you move it forward over the card.

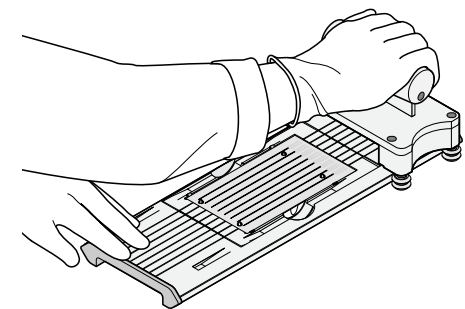

- e. Remove the sealed array card from the fixture and trim the fill reservoirs from the array card assembly using scissors. Trim the foil array card so that the edge is even with the plastic carrier.

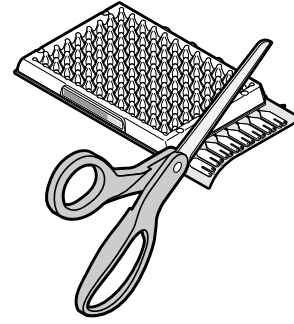

IMPORTANT! Completely remove the fill reservoirs from the array card so that the edge is free of residual plastic. The plastic from the fill reservoirs that extends beyond the edge of the card can prevent the array card from seating properly on the sample block and can affect amplification.

Correct trim	Incorrect trim
A diagram showing a cross-section of an array card edge. The foil is perfectly flush with the plastic carrier, and the wells are clearly defined.	A diagram showing a cross-section of an array card edge where the foil has been cut unevenly, leaving a jagged, protruding edge that would not seat properly.

9. Repeat step 8 to seal the remaining array cards.

IMPORTANT! If an array card is sealed improperly, it can leak and contaminate the sample block and/or it can cause the associated calibration or RNase P test to fail.

IMPORTANT! As you seal the remaining filled array cards, store them in a dark place. Do not expose the array cards to light until you are ready to use them. The dyes in the array cards are photosensitive. Prolonged exposure to light can diminish the fluorescence of the dye.

ROI calibration

A region of interest (ROI) calibration maps the positions of the wells on the sample block of the instrument. The software uses the ROI calibration data to associate increases in fluorescence during a run with the wells on the plate or array card. The instrument uses a set of optical filters to distinguish the fluorescence emissions gathered during runs. The software generates a calibration image for each filter to account for minor differences in the optical path.

When to perform the calibration

Perform the ROI calibration once every 6 months.

IMPORTANT! After every ROI calibration, you must perform (in order): a background calibration, uniformity calibration, dye calibration, and a normalization calibration.

About the calibration data

During the ROI calibration, the instrument software captures images of the ROI calibration plate or array card at each instrument filter. An ROI calibration passes if the collected image for each filter distinguishes all wells of the ROI plate or array card. Each well in the image must be distinct and visible at the same luminosity relative to the other wells in the image.

Note: You can review the ROI calibration image for each filter set by selecting the desired filter combination from the Filter Set menu of the ROI tab in the Instrument Manager.

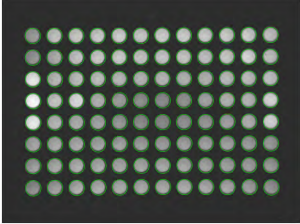
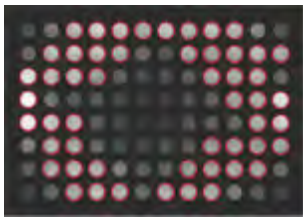
Passing image	Failing image
 <p data-bbox="224 848 805 972">Green circles around <i>all</i> wells indicate that the wells calibrated successfully. Each green circle indicates that the region of interest for the well position is sufficiently bright.</p>	 <p data-bbox="837 848 1403 972">Red circles around some of the wells indicate that the wells did not calibrate. The absence of a circle indicates that the region of interest for the well position is not sufficiently bright.</p>

Preparing the calibration plate or array card

IMPORTANT! Wear powder-free gloves and safety glasses when you prepare plates or array cards.

Prepare the calibration consumable appropriate for your QuantStudio™ 6 or 7 Flex System:

- “Prepare the ROI calibration plate” on page 38
- “Preparing array cards for instrument calibration” on page 33

Prepare the ROI calibration plate

Materials required

- Region of Interest (ROI) Plate
- Centrifuge with plate adapter
- Powder-free gloves
- Safety goggles

Prepare the plate

IMPORTANT! Wear powder-free gloves and safety glasses when you prepare the plate.

1. Remove the ROI calibration plate from the freezer, then thaw it at room temperature for approximately 30 minutes.

IMPORTANT! Use the calibration plate within 2 hours of defrosting it. Until you are ready to run the plate, store it in the dark and at ambient temperature (15–30°C). Do not remove the calibration plate from its packaging until you are ready to run it. The fluorescent dyes in the wells of the plate are photosensitive. Prolonged exposure to light can diminish the fluorescence of the dyes.

2. Remove the ROI plate from its packaging. Do not remove the optical film.
3. Vortex and centrifuge the plate:
 - a. Vortex the ROI calibration plate for 5 seconds.
 - b. Centrifuge the plate for 2 minutes at < 1500 rpm.

IMPORTANT! The ROI calibration plate must be well mixed and centrifuged.

- c. Confirm that the liquid in each well of the ROI calibration plate is at the bottom of the well. If not, centrifuge the plate again at a higher rpm and for a longer period of time.

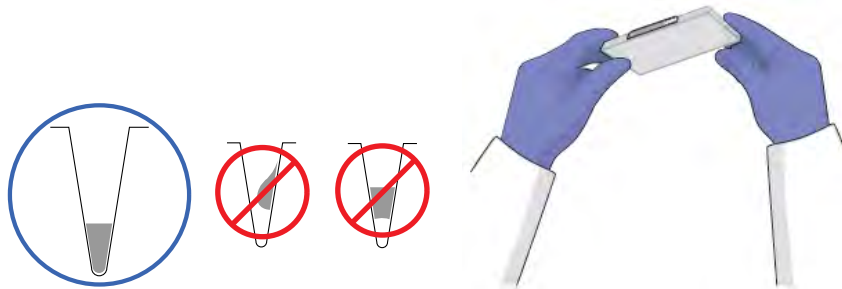

Perform the ROI calibration

1. In the QuantStudio™ Real-Time PCR Software **Home** tab, click **Instrument Console**.
2. In the **Instrument Console**, select the icon for your instrument, then click **Manage Instrument**.

Note: If the **Manage Instrument** button is inactive, add your system to the **My Instruments** group.

3. In the **Instrument Manager**, start the calibration:
 - a. Click  **Maintenance**, then click **ROI**.
 - b. In the **ROI Calibration** screen, click **Start Calibration**.
4. Click **Next**, then prepare for the calibration as instructed.

5. From the bottom of the **Setup** tab, enter the reagent information for the ROI plate or array card that you are using.

Reagent Information

Plate Barcode	Reagent Name	Reagent Part Number	Reagent Lot Number	Reagent Expiration Date

Check the box when the ROI calibration plate has been loaded, and when you have ensured you have entered all reagents information correctly

Cancel Previous Next Finish

Instrument Con... 287680008 x

6. Load the calibration plate or array card into the instrument:
- From the instrument touchscreen, tap  to eject the instrument tray.
 - Load the plate or array card into the plate holder so that:
 - Well A1 of the plate or array card is in the top-left corner of the plate adapter.
 - The barcode faces the front of the instrument.

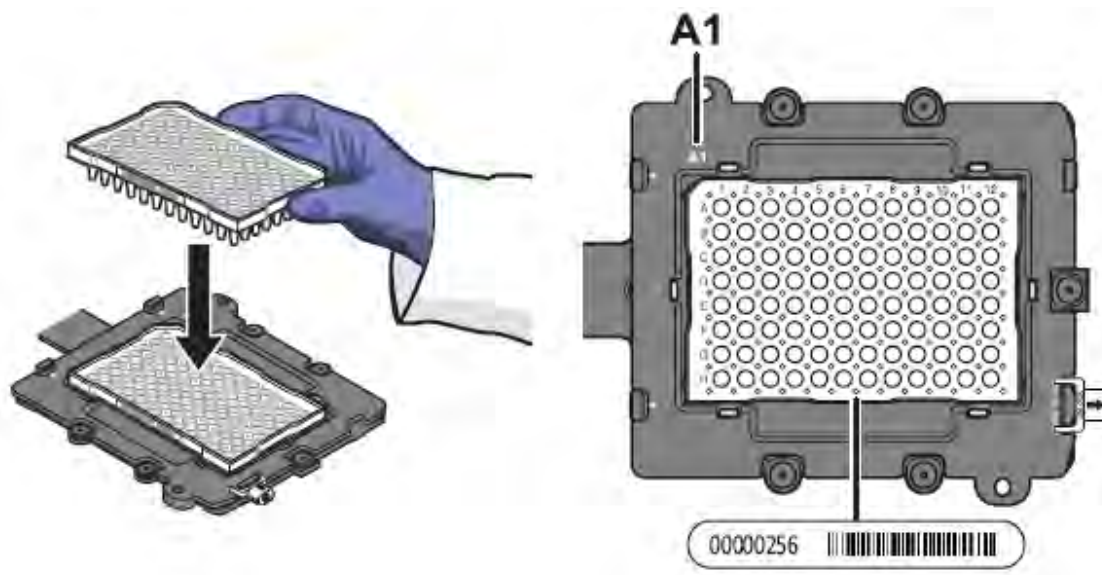

IMPORTANT! Plates and array cards should be loaded and unloaded by operators who have been warned of the moving parts hazard and have been adequately trained.

- From the instrument touchscreen, tap  to close the instrument tray.
7. After loading the plate or array card, start the calibration:
- At the bottom of the **Setup** tab, select **Check the box when the ROI calibration plate has been loaded**, then click **Next**.
 - In the **Run** screen, click **Start run**.

IMPORTANT! Do not attempt to open the access door during the run. The door is locked while the instrument is in operation.

Note: Before starting the calibration, the instrument may pause (up to 10 minutes) to allow the heated cover to reach the required temperature.

8. When the run is complete and the software displays the **Analysis** screen, select each filter from the **Filter Set** drop-down list, then confirm that the corresponding ROI Image displays a green circle around each well area.
9. After you inspect all ROI images, confirm the status of the calibration, where *passed* indicates that the run produced viable calibration data, and *failed* indicates that the run did not produce data or that the data it collected is unusable.

Analysis status	Action
Passed	Click Next .
Failed	Troubleshoot the failed calibration (see “Troubleshooting” on page 71).

10. Unload the calibration plate or array card:
 - a. After the calibration, tap  on the touchscreen to eject the plate or array card.

Note: If the instrument does not eject the plate or array card, remove it as explained in “Troubleshooting” on page 71.

 - b. Remove the ROI calibration plate or array card from the instrument tray and store it in the dark at room temperature until you are ready to perform the uniformity calibration.



WARNING! PHYSICAL INJURY HAZARD. During instrument operation, the plate or array card temperature can reach 100°C. Allow the consumable to cool to room temperature before removing.

- c. Tap  on the instrument touchscreen to close the instrument tray.
11. In the **ROI Calibration** screen, click **Finish** to complete the calibration, then click **Yes** when prompted to save the results.

Note: If the QuantStudio™ Real-Time PCR Software displays the warning **Saving ROI calibration will invalidate other existing calibrations except HRM Calibrations**, click **OK** to proceed.

Note: HRM (High Resolution Melt) is a separately licensed module. If your instrument requires this module, contact Thermo Fisher Scientific.

12. (Optional) Click **Print Report** in the upper right corner of the screen to print a summary of the calibration results for your records.

Background calibration

The software uses the background calibration data during subsequent experiments to remove background fluorescence from the experiment data.

When to perform the calibration

Perform the background calibration monthly.

About the calibration data

During the background calibration, the software captures a series of images of the background plate or array card using each instrument filter. The software compares the fluorescence from each well to the average for the plate or array card. A background calibration passes if the collected images for all filters are free of abnormal fluorescence.

Background fluorescence

Fluorescence data collected by the instrument includes a fluorescence signal inherent to the instrument, referred to as “background fluorescence.” Background fluorescence is a composite signal found in all spectral data that consists of fluorescence from several sources, including:

- Background electronic signal
- Contaminants in the sample block
- The plastic consumable (plate or array card)

Preparing the calibration plate or array card

IMPORTANT! Wear powder-free gloves and safety glasses when you prepare plates or array cards.

Prepare the calibration consumable appropriate for your QuantStudio™ 6 or 7 Flex System:

- “Prepare the background calibration plate” on page 42
- “Preparing array cards for instrument calibration” on page 33

Prepare the background calibration plate

Materials required

- Background Plate
- Centrifuge with plate adapter
- Powder-free gloves
- Safety goggles

Prepare the plate

IMPORTANT! Wear powder-free gloves and safety glasses when you prepare the plate.

1. Remove the background calibration plate from the freezer, then thaw it at room temperature for approximately 30 minutes.

IMPORTANT! Use the calibration plate within 2 hours of defrosting it. Until you are ready to run the plate, store it in the dark and at ambient temperature (15–30°C). Do not remove the plate from its packaging until you are ready to run it.

2. Remove the background calibration plate from its packaging. Do not remove the optical film.
3. Vortex and centrifuge the plate:
 - a. Vortex the background calibration plate for 5 seconds.
 - b. Centrifuge the plate for 2 minutes at <1500 rpm.

IMPORTANT! The background calibration plate must be well mixed and centrifuged.

- c. Confirm that the liquid in each well of the background calibration plate is at the bottom of the well. If not, centrifuge the plate again at a higher rpm and for a longer period of time.

IMPORTANT! Do not allow the bottom of the plate to become dirty. Fluids and other contaminants that adhere to the plate bottom can contaminate the sample block and cause an abnormally high background signal.

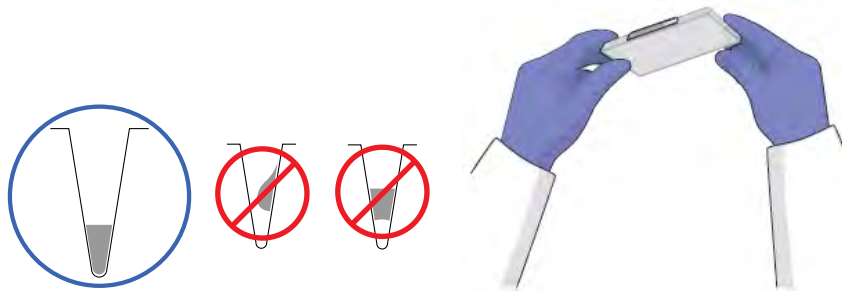

Perform the background calibration

1. In the QuantStudio™ Real-Time PCR Software **Home** tab, click **Instrument Console**.
2. In the **Instrument Console**, select the icon for your instrument, then click **Manage Instrument**.

Note: If the **Manage Instrument** button is inactive, add your instrument to the **My Instruments** group.

3. In the **Instrument Manager**, start the calibration:
 - a. Click  **Maintenance**, then click **Background**.

- b. In the **Background Calibration** screen, click **Start Calibration**.
4. Click **Next**, then prepare for the calibration as instructed.
5. At the bottom of the **Setup** tab, enter the reagent information for the background plate or array card that you are using.

Reagent Information

Plate Barcode	Reagent Name	Reagent Part Number	Reagent Lot Number	Reagent Expiration Date

Check the box when the background calibration plate has been loaded, and when you have ensured you have entered all reagents information correctly

Cancel Previous Next Finish

Instrument Con... 287880008 x

6. Load the calibration plate or array card into the instrument:
 - a. From the instrument touchscreen, tap  to eject the instrument tray.
 - b. Load the calibration plate or array card into the plate holder so that:
 - Well A1 of the plate or array card is in the top-left corner of the plate adapter.
 - The barcode faces the front of the instrument.

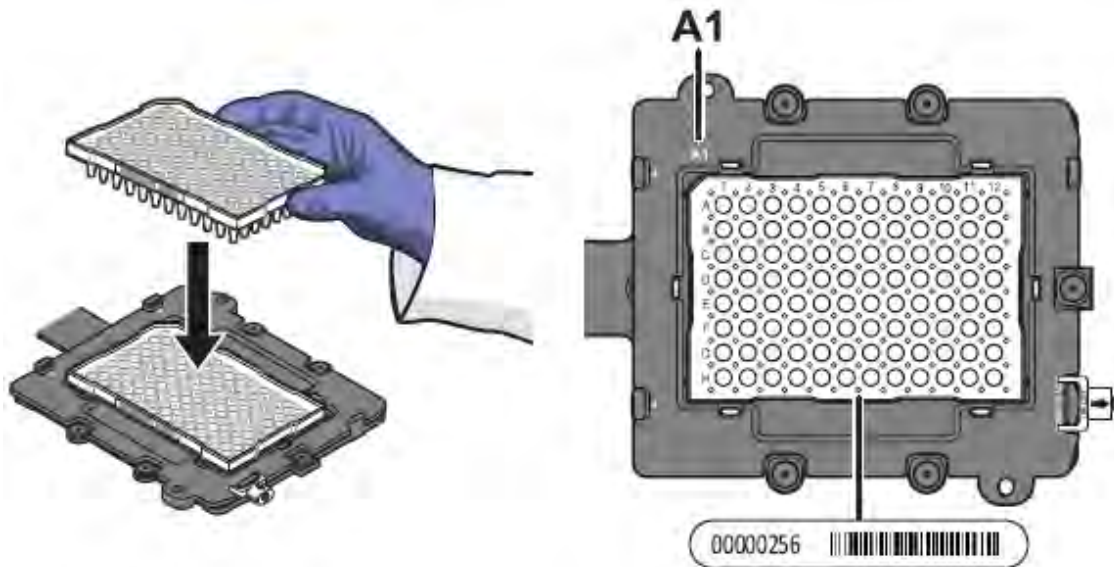

IMPORTANT! Plates or array cards should be loaded and unloaded by operators who have been warned of the moving parts hazard and have been adequately trained.

- c. From the instrument touchscreen, tap  to close the instrument tray.
7. After loading the plate or array card, start the calibration:
 - a. In the **Setup** tab, select **Check the box when the background calibration plate has been loaded**, then click **Next**.

- b. From the **Run** screen, click **Start Run**.

IMPORTANT! Do not attempt to open the access door during the run. The door is locked while the instrument is in operation.

Note: Before starting the calibration, the instrument may pause (up to 10 minutes) to allow the heated cover to reach the required temperature.

8. When the run is complete and the QuantStudio™ Real-Time PCR Software displays the **Analysis** screen, confirm the status of the calibration. The analysis status indicates the success of the calibration, where *passed* indicates that the run produced viable calibration data, and *failed* indicates that the run did not produce data or that the data it collected is unusable.

Analysis status	Action
Passed	Click Next .
Failed	Troubleshoot the failed calibration (see “Troubleshooting” on page 71).

Note: Abnormal spectra or abnormally high background fluorescence can indicate the presence of contamination on the plate or array card or sample block, which can cause the calibration to fail.

9. Select the **QC** tab to review the quality check summary. The QC status indicates the quality of the calibration data, where **Passed** indicates that all wells produced data that passed the quality check, and **Failed** indicates that one or more wells produced spectra that deviate significantly from the other wells on the plate or array card.

Note: If the calibration failed, the **QC** tab can provide information regarding the cause of the failure.

10. Unload the calibration plate or array card:
- a. After the calibration, tap  on the touchscreen to eject the plate or array card.

Note: If the instrument does not eject the plate or array card, remove it as explained in “Troubleshooting” on page 71.

- b. Remove the plate or array card from the instrument tray and discard it.



WARNING! PHYSICAL INJURY HAZARD. During instrument operation, the plate or array card temperature can reach 100°C. Allow the consumable to cool to room temperature before removing.

- c. Tap  on the instrument touchscreen to close the instrument tray.

11. From the **Background Calibration** screen, click **Finish** to complete the calibration, then click **Yes** when prompted to save the results.
12. (Optional) Click **Print Report** in the upper right corner of the screen to print a summary of the calibration results for your records.

Uniformity calibration

The uniformity calibration generates data that allows the software to compensate for the physical effects of the instrument filters.

When to perform the calibration

Perform a uniformity calibration once every 6 months.

Preparing the calibration plate or array card

IMPORTANT! Wear powder-free gloves and safety glasses when you prepare plates or array cards.

Prepare the calibration consumable appropriate for your QuantStudio™ 6 or 7 Flex System:

- “Prepare the ROI calibration plate” on page 46
- “Preparing array cards for instrument calibration” on page 33

Prepare the ROI calibration plate

Materials required

Note: The uniformity calibration requires the same materials used to perform the ROI calibration.

- Region of Interest (ROI) Plate
- Centrifuge with plate adapter
- Powder-free gloves
- Safety goggles

Prepare the plate

IMPORTANT! Wear powder-free gloves and safety glasses when you prepare the plate.

If you have a prepared ROI calibration plate from a recent ROI calibration, go to step 3b; otherwise, prepare the ROI calibration plate as follows:

1. Remove the ROI calibration plate from the freezer, then thaw it at room temperature for approximately 30 minutes.

IMPORTANT! Use the calibration plate within 2 hours of defrosting it. Until you are ready to run the plate, store it in the dark and at ambient temperature (15–30°C). Do not remove the plate from its packaging until you are ready to run it.

2. Remove the ROI plate from its packaging. Do not remove the optical film.
3. Vortex and centrifuge the plate:
 - a. Vortex the ROI calibration plate for 5 seconds.

- b. Centrifuge the plate for 2 minutes at < 1500 rpm.

IMPORTANT! The ROI calibration plate must be well mixed and centrifuged.

- c. Confirm that the liquid in each well of the ROI calibration plate is at the bottom of the well. If not, centrifuge the plate again at a higher rpm and for a longer period of time.

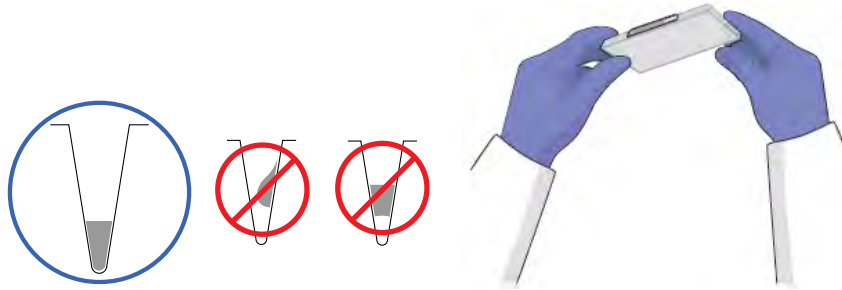

Perform the uniformity calibration

1. In the QuantStudio™ Real-Time PCR Software **Home** tab, click **Instrument Console**.
2. In the **Instrument Console**, select the icon for your instrument, then click **Manage Instrument**.

Note: If the **Manage Instrument** button is inactive, add your instrument to the **My Instruments** group.



3. From the **Instrument Manager**, start the calibration:
 - a. Click  **Maintenance**, then click **Uniformity**.
 - b. From the **Uniformity Calibration** screen, click **Start Calibration**.
4. Click **Next**, then prepare for the calibration as instructed.
5. At the bottom of the **Setup** tab, enter the reagent information for the ROI plate or array card that you are using.

Plate Barcode	Reagent Name	Reagent Part Number	Reagent Lot Number	Reagent Expiration Date

Check the box when the ROI calibration plate has been loaded, and when you have ensured you have entered all reagents information correctly

Cancel Previous Next Finish

6. Load the calibration plate or array card into the instrument:
 - a. From the instrument touchscreen, tap  to eject the instrument tray.

- b. Load the calibration plate or array card into the plate holder so that:
- Well A1 of the plate or array card is in the top-left corner of the plate adapter.
 - The barcode faces the front of the instrument.

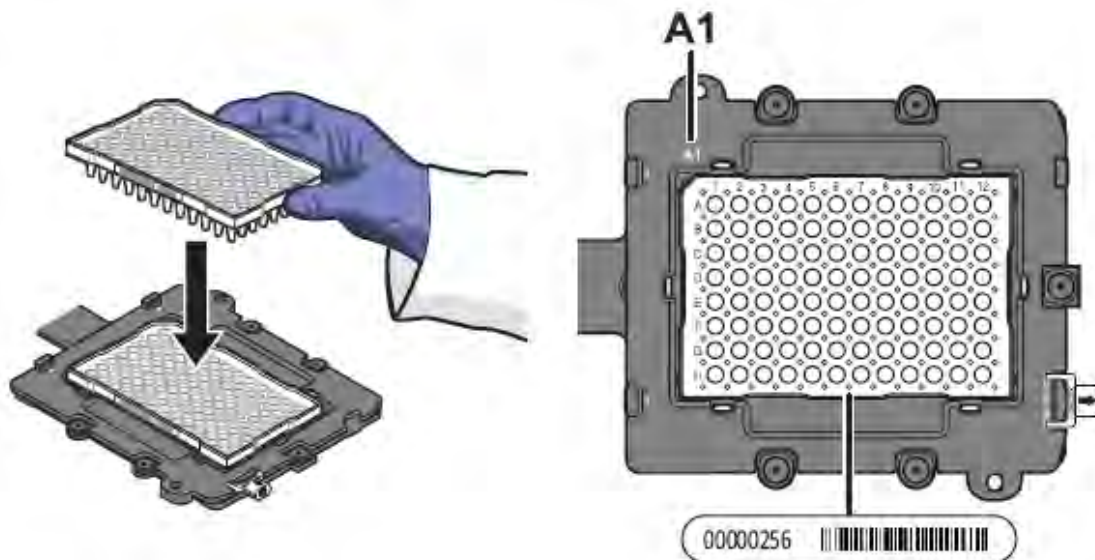

IMPORTANT! Plates or array cards should be loaded and unloaded by operators who have been warned of the moving parts hazard and have been adequately trained.

- c. From the instrument touchscreen, tap  to close the instrument tray.
7. After loading the plate or array card, start the calibration:
- In the **Setup** tab, select **Check the box when the ROI calibration plate has been loaded**, then click **Next**.
 - In the **Run** screen, click **Start Run**.

IMPORTANT! Do not attempt to open the access door during the run. The door is locked while the instrument is in operation.

Note: Before starting the calibration, the instrument may pause (up to 10 minutes) to allow the heated cover to reach the required temperature.

8. When the run is complete and the **Analysis** screen displays, confirm the status of the calibration. The analysis status indicates the success of the calibration, where *passed* indicates that the run produced viable calibration data, and *failed* indicates that the run did not produce data or that the data it collected is unusable.

Analysis status	Action
Passed	Click Next .
Failed	Troubleshoot the failed calibration (see “Troubleshooting” on page 71).

9. Select the **QC** tab to review the quality check summary.

Note: The **QC** tab can provide information on the cause of a failed calibration.

10. Unload the calibration plate or array card:
 - a. After the calibration, tap  on the touchscreen to eject the plate or array card.

Note: If the instrument does not eject the plate or array card, remove it as explained in “Troubleshooting” on page 71.

- b. Remove the calibration plate or array card from the instrument tray and discard it.



WARNING! PHYSICAL INJURY HAZARD. During instrument operation, the plate or array card temperature can reach 100°C. Allow the consumable to cool to room temperature before removing.

- c. Tap  on the instrument touchscreen to close the instrument tray.
11. From the **Uniformity Calibration** screen, click **Finish** to complete the calibration, then click **Yes** when prompted to save the results.
12. (Optional) Click **Print Report** in the upper right corner of the screen to print a summary of the calibration results for your records.

Dye calibration

The software uses the calibration data collected from the dye standards to characterize and distinguish the individual contribution of each dye in the total fluorescence collected by the instrument. After each run, the instrument software receives data in the form of a raw spectra signal for each reading. The software determines the contribution of the fluorescent dyes used in each reaction by comparing the raw spectra to the pure spectra calibration data. When you save an experiment after analysis, the instrument software stores the pure spectra with the collected fluorescence data for that experiment.

When to perform the calibration

Perform a dye calibration once every 6 months.

IMPORTANT! Perform a background calibration before every series of dye calibrations. Because the age and use of instrument components can affect spectra readings, you must perform a dye calibration at least every 6 months.

About the dye calibration data

The product of a dye calibration is a collection of spectral profiles that represent the fluorescence signature of each dye standard. Each profile consists of a set of spectra that correspond to the fluorescence collected from the wells of the calibration plate or array card. Following the calibration of each dye, the software “extracts” a spectral profile for each dye. The software plots the resulting data for each profile in a graph of fluorescence versus filter.

When the software extracts the dye calibration data, it evaluates the fluorescence signal generated by each well in terms of the collective spectra for the entire calibration plate or array card. Dye spectra are generally acceptable if they peak within the same filter as their group, but diverge slightly at other wavelengths (see below).

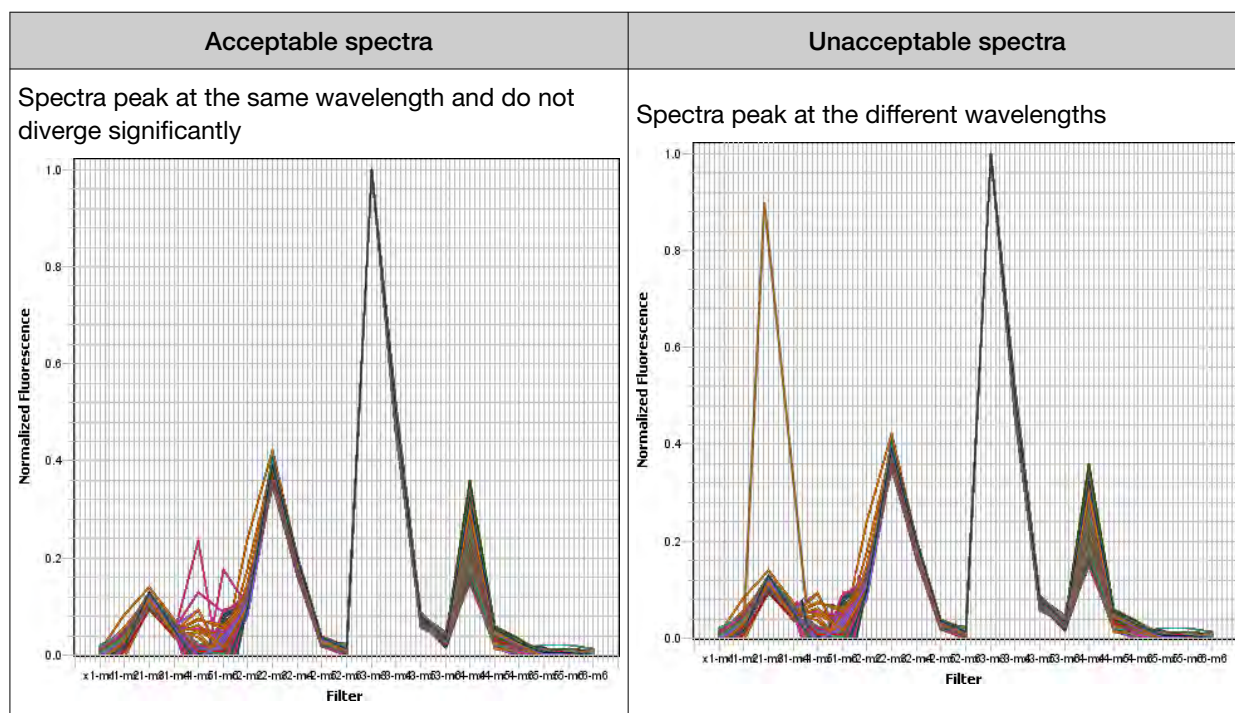

Note: Because the wells of a calibration plate or array card contain identical concentrations of a dye, the resulting signals for the wells should be similar. Variations in spectral position and peak position are caused by minor differences in the optical properties and excitation energy between the individual wells.

Preparing the calibration plate or array card

IMPORTANT! Wear powder-free gloves and safety glasses when you prepare plates or array cards.

Prepare the calibration consumable appropriate for your QuantStudio™ 6 or 7 Flex System:

- “Prepare the dye calibration plates” on page 51
- “Preparing array cards for instrument calibration” on page 33

Prepare the dye calibration plates

Materials required

- Spectral calibration plates
 - Spectral Calibration Plate with FAM™ Dye
 - Spectral Calibration Plate with VIC™ Dye
 - Spectral Calibration Plate with ROX™ Dye
 - Spectral Calibration Plate with NED™ Dye
 - Spectral Calibration Plate with TAMRA™ Dye
 - Spectral Calibration Plates as required by the experiment that you intend to run
- Centrifuge with plate adapter
- Powder-free gloves
- Safety goggles

Prepare the plate

IMPORTANT! Before performing a dye calibration, you must perform an ROI calibration, a background calibration, and a uniformity calibration.

IMPORTANT! Wear powder-free gloves and safety glasses when you prepare the plate.

1. Remove the dye calibration plate from the freezer, then thaw it at room temperature for approximately 30 minutes.

IMPORTANT! Use the calibration plates within 2 hours of defrosting them. Until you are ready to run the plates, store them in the dark and at ambient temperature (15–30°C). Do not remove the plates from their packaging until you are ready to run them.

2. Before using each dye plate, vortex the plate for 5 seconds, centrifuge it for 2 minutes at < 1500 rpm, then confirm that the liquid in each dye plate is at the bottom of the wells. If not, centrifuge the plate again at a higher rpm and for a longer period of time.

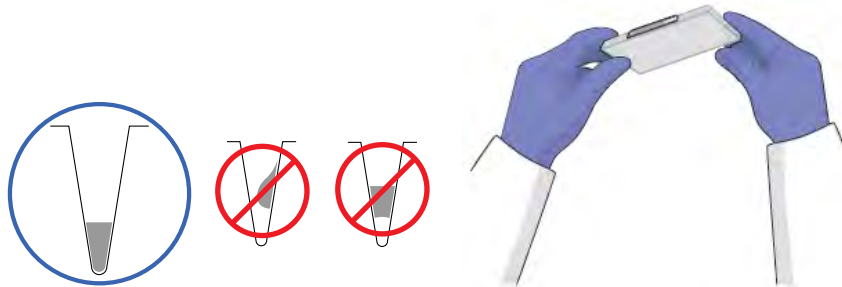

Perform the dye calibration

IMPORTANT! The software guides you through the calibration of each dye separately. You must set up, run, and analyze each dye independently.

1. In the QuantStudio™ Real-Time PCR Software **Home** tab, click **Instrument Console**.
2. In the **Instrument Console**, select the icon for your instrument, then click **Manage Instrument**.

Note: If the **Manage Instrument** button is inactive, add your system to the **My Instruments** group.

3. In the **Instrument Manager**, start the calibration:
 - a. Click  **Maintenance**, then click **Dye**.
 - b. In the **Dye Calibration** screen, select **System Dye Calibration**, then click **Start Calibration**.
4. In the **Dye Calibration** screen, select the dye to calibrate from the **Dye Name** drop-down list, then perform the calibration as instructed.
5. At the bottom of the **Setup** tab, enter the reagent information for the dye plate or array card that you are using.

Reagent Information

Plate Barcode	Reagent Name	Reagent Part Number	Reagent Lot Number	Reagent Expiration Date

Check the box when the dye calibration plate has been loaded, and when you have ensured you have entered all reagents information correctly

Instrument Coni...
287880008
x

6. Load the dye plate or array card into the instrument:
 - a. From the instrument touchscreen, tap  to eject the instrument tray.

- b. Confirm that the dye plate or array card matches the dye selected in the software, then load it into the plate holder.

Load the plate or array card so that:

- Well A1 of the plate or array card is in the top-left corner of the plate adapter.
- The barcode faces the front of the instrument.

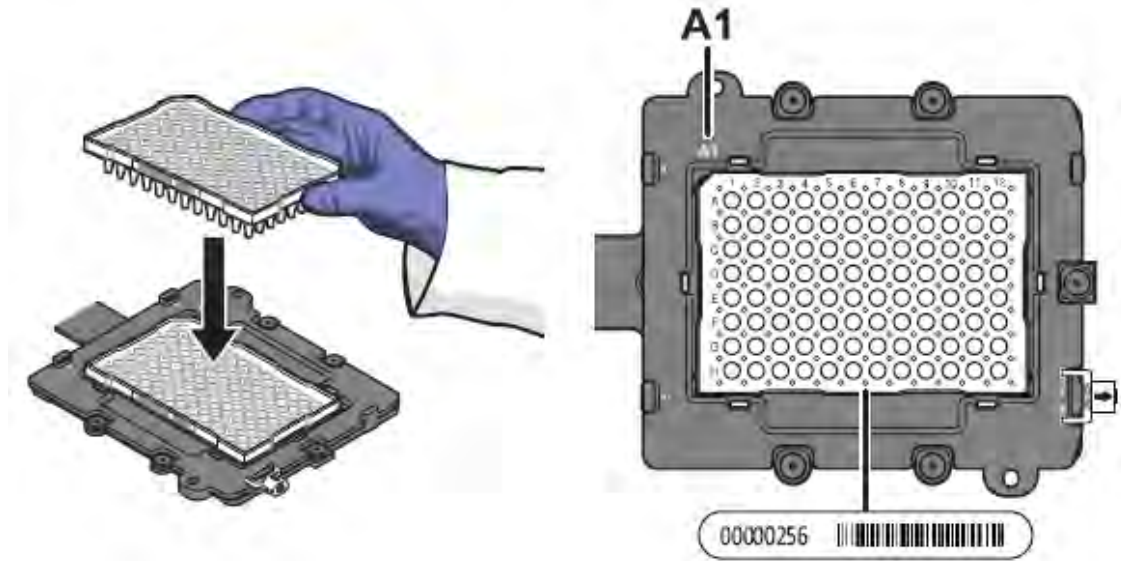

Note: The name of the dye contained by the plate or array card is next to the barcode on the front of it.

IMPORTANT! Plates or array cards should be loaded and unloaded by operators who have been warned of the moving parts hazard and have been adequately trained.

- c. From the instrument touchscreen, tap  to close the instrument tray.
7. After loading the plate or array card, start the calibration:
 - a. In the **Dye Calibration** screen, select **Check the box when the dye calibration plate has been loaded**, then click **Next**.
 - b. In the **Run** screen, click **Start Run**.

IMPORTANT! Do not attempt to open the access door during the run. The door is locked while the instrument is in operation.

Note: Before starting the calibration, the instrument may pause (up to 10 minutes) to allow the heated cover to reach the required temperature.

8. When the run is complete and the software displays the **Analysis** screen, confirm the grouping of the dye spectra:
- Select the **Plate Layout** tab, then review the raw data. For each spectrum, confirm that the peak is:
 - Within the detectable range for the QuantStudio™ 6 and 7 Flex Systems.
 - Free of irregular spectral peaks.
 - Present at the correct filter for the dye (see “Instrument filters and supported dyes” on page 15).

Note: Among wells containing the same dye, variations in spectral position and peak position are caused by minor differences in the optical properties and excitation energy between the individual wells.

- Select the **QC** tab, then review the summary of wells that failed the quality check (QC).
9. After you inspect the dye spectra, confirm the analysis status of the calibration. The analysis status indicates the success of the calibration, where *passed* indicates that the run produced viable calibration data, and *failed* indicates that the run did not produce data or that the data it collected is unusable.

Analysis status	Action
Passed	<ol style="list-style-type: none"> Click Next. Enter comments in the Comments field, click Finish, then click Yes when prompted to save the results.
Failed	Troubleshoot the failed calibration (see “Troubleshooting” on page 71).

10. Select the **QC** tab to review the quality check summary. The QC status indicates the quality of the calibration data, where *passed* indicates that all wells produced data that passed the quality check, and *failed* indicates that one or more wells produced dye spectra that differ significantly from the other wells on the plate or array card.

Note: If the calibration failed, the **QC** tab can provide information regarding the cause of the failure.

11. Unload the calibration plate or array card:
- After the calibration, tap  on the touchscreen to eject the plate or array card.

Note: If the instrument does not eject the plate or array card, remove it as explained in “Troubleshooting” on page 71.

- Remove the calibration plate or array card from the instrument tray and discard it.



WARNING! PHYSICAL INJURY HAZARD. During instrument operation, the plate or array card temperature can reach 100°C. Allow the consumable to cool to room temperature before removing.

- c. Touch  on the instrument touchscreen to close the instrument tray.
12. Repeat the calibration to calibrate the instrument for the remaining dyes that are present in the experiments that you will be running.
13. (Optional) Click **Print Report** in the upper right corner of the screen to print a summary of the calibration results for your records.

Normalization calibration

During the normalization calibration, the instrument collects and stores the data from the normalization standards.

When to perform the calibration

Perform a normalization calibration once every 6 months.

Note: Normalization calibration is required for all block types with QuantStudio™ Real-Time PCR Software v1.3.

About the calibration data

During the normalization calibration, the software captures a series of images of each normalization plate or array card using each instrument filter. The normalization calibration yields a “Pass” or “Fail” result for each normalization consumable used.

Preparing the calibration plate or array card

IMPORTANT! Wear powder-free gloves and safety glasses when you prepare plates or array cards.

Prepare the calibration consumable appropriate for your QuantStudio™ 6 or 7 Flex System:

- “Prepare the normalization calibration plates” on page 55
- “Preparing array cards for instrument calibration” on page 33

Prepare the normalization calibration plates

Materials required

- Normalization Plate with FAM™/ROX™ dyes
- Normalization Plate with VIC™/ROX™ dyes
- Centrifuge with plate adapter
- Powder-free gloves
- Safety goggles

Prepare the plate

IMPORTANT! Before performing a normalization calibration, you must perform an ROI calibration, a background calibration, a uniformity calibration, and a dye calibration.

IMPORTANT! Wear powder-free gloves and safety glasses when you prepare the plate.

1. Remove the normalization calibration plates from the freezer, then allow them to warm to room temperature (approximately 30 minutes).

IMPORTANT! Use the calibration plates within 2 hours of defrosting them. Until you are ready to run the plates, store them in the dark and at ambient temperature (15–30°C). Do not remove the plates from their packaging until you are ready to run them.

2. Go to “Perform the normalization calibration” on page 56.

Before using each normalization plate, vortex the plate for 5 seconds, centrifuge it for 2 minutes at < 1500 rpm, then confirm that the liquid in each dye plate is at the bottom of the wells. If not, centrifuge the plate again at a higher rpm and for a longer period of time.

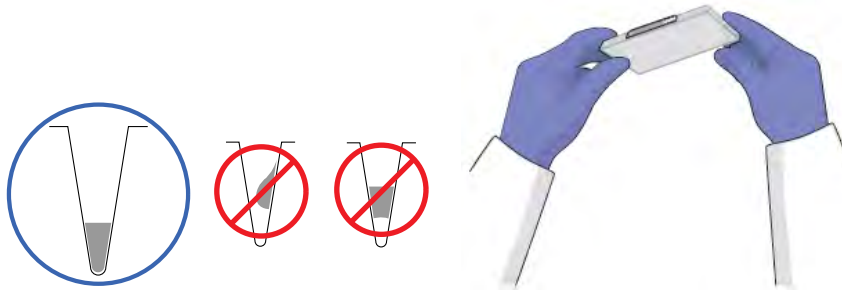

Perform the normalization calibration

1. In the QuantStudio™ Real-Time PCR Software **Home** tab, click **Instrument Console**.
2. In the **Instrument Console**, select the icon for your instrument, then click **Manage Instrument**.

Note: If the **Manage Instrument** button is inactive, add your system to the **My Instruments** group.

3. In the **Instrument Manager**, start the calibration:
 - a. Click  **Maintenance**, then click **Normalization**.
 - b. In the **Normalization Calibration** screen, click **Start Calibration**.
4. In the **Normalization Calibration** screen, select the reporter and passive dye combination that you want to calibrate, then perform the calibration as instructed.

5. From the bottom of the **Setup** tab, enter the reagent information for the normalization plate or array card that you are using.

Reagent Information

Plate Barcode	Reagent Name	Reagent Part Number	Reagent Lot Number	Reagent Expiration Date

Check the box when the normalization calibration plate has been loaded, and when you have ensured you have entered all reagents information correctly

Cancel Previous Next Finish

Instrument Con... 287880008 x

6. Load the calibration plate or array card into the instrument:
 - a. From the instrument touchscreen, tap  to eject the instrument tray.
 - b. Confirm that the normalization plate or array card matches the selection in the software, then load it into the plate holder so that:
 - Well A1 of the plate or array card is in the top-left corner of the plate adapter.
 - The barcode faces the front of the instrument.

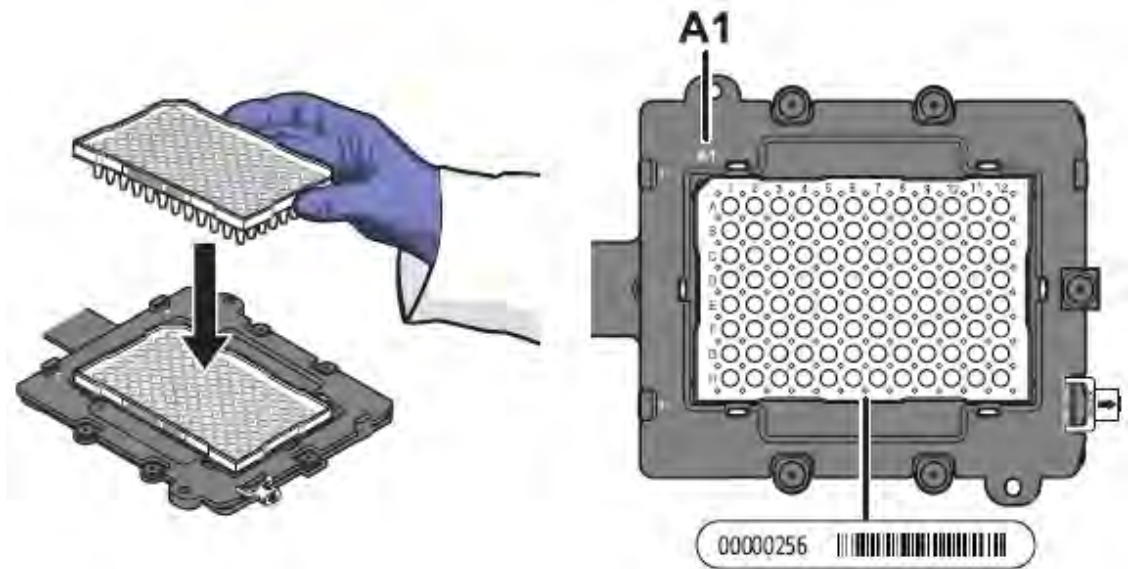

Note: The dyes contained in each plate or array card appear next to the barcode on the front of it.

IMPORTANT! Plates or array cards should be loaded and unloaded by operators who have been warned of the moving parts hazard and have been adequately trained.

- c. From the instrument touchscreen, touch  to close the instrument tray.
7. After loading the array card, start the calibration:
 - a. In the **Normalization Calibration** screen tab, select **Check the box when the normalization calibration plate has been loaded**, then click **Next**.

- b. In the **Run** screen, click **Start Run**.

IMPORTANT! Do not attempt to open the access door during the run. The door is locked while the instrument is in operation.

Note: Before starting the calibration, the instrument may pause (up to 10 minutes) to allow the heated cover to reach the required temperature.

8. When the run is complete and the QuantStudio™ Real-Time PCR Software displays the **Analysis** screen, confirm the status of the calibration. The analysis status indicates the success of the calibration, where *passed* indicates that the run produced viable calibration data, and *failed* indicates that the run did not produce data or that the data it collected is unusable.

Analysis status	Action
Passed	Enter comments in the Comments field, click Next .
Failed	Troubleshoot the failed calibration (see “Troubleshooting” on page 71).

9. Select the **QC** tab to review the quality check summary. The QC status indicates the quality of the calibration data, where *passed* indicates that all wells produced data that passed the quality check, and *failed* indicates that one or more wells produced unusable data.

Note: If the calibration failed, the **QC** tab can provide information regarding the cause of the failure.

10. Unload the calibration plate or array card:

- a. After the calibration, tap  on the touchscreen to eject the plate or array card.

Note: If the instrument does not eject the plate or array card, remove it as explained in “Troubleshooting” on page 71.

- b. Remove the calibration plate or array card from the instrument tray and discard it.



WARNING! PHYSICAL INJURY HAZARD. During instrument operation, the plate or array card temperature can reach 100°C. Allow the consumable to cool to room temperature before removing.

- c. Tap  on the instrument touchscreen to close the instrument tray.

11. In the **Normalization Calibration** screen, click **Finish** to complete the calibration, then click **Yes** when prompted to save the results.
12. Repeat the calibration procedure to perform the remaining normalization calibration.
13. (Optional) Click **Print Report** in the upper right corner of the screen to print a summary of the calibration results for your records.

Verify the instrument performance

When necessary, you can perform the RNase P instrument verification test to confirm the performance of the QuantStudio™ 6 and 7 Flex Systems.

When to perform the test

We recommend performing an RNase P instrument verification test:

- After moving the instrument to another location.
- As needed to confirm the function of the instrument.

About the RNase P kits

The RNase P instrument verification test uses instrument verification kits available from [thermofisher.com](https://www.thermofisher.com). The kits differ only in the consumable format for which they are designed: an RNase P Instrument Verification Plate for QuantStudio™ 6 and 7 Flex Systems with 96/384-well sample blocks and an Array Card RNase P Kit for the QuantStudio™ 7 Flex System with array card sample blocks.

RNase P instrument verification plates

The RNase P plate is preloaded with the reagents necessary for the detection and quantitation of genomic copies of the human RNase P gene (a single-copy gene encoding the RNase moiety of the RNase P enzyme). Each well contains: PCR master mix, RNase P primers, FAM™ dye-labeled probe, and a known concentration of human genomic DNA template.

Figure 1 illustrates the arrangement of the standard and unknown populations on a 96-well and Fast 96-well RNase P plate. The RNase P plate contains five replicate groups of standards (1250, 2500, 5000, 10000, and 20000 copies), two unknown populations (5,000 and 10,000 copies), and a no template control (NTC).

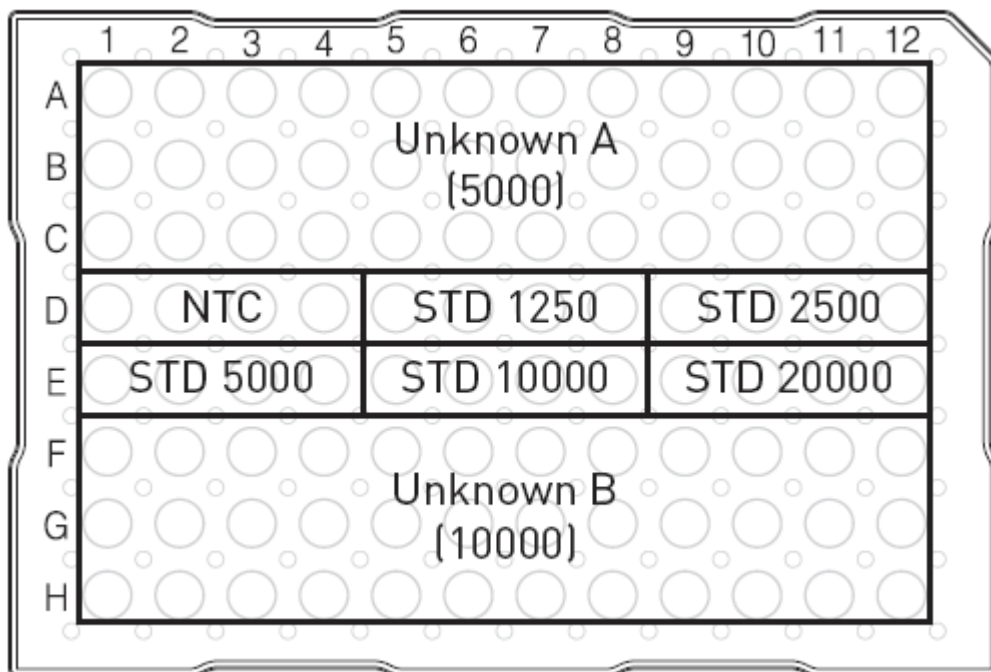

Figure 1 96-well and Fast 96-well RNase P plate layout

Figure 2 illustrates the arrangement of the standard and unknown populations on a 384-well RNase P plate. The RNase P plate contains five replicate groups of standards (1250, 2500, 5000, 10000, and 20000 copies), two unknown populations (5,000 and 10,000 copies), and a no template control (NTC).

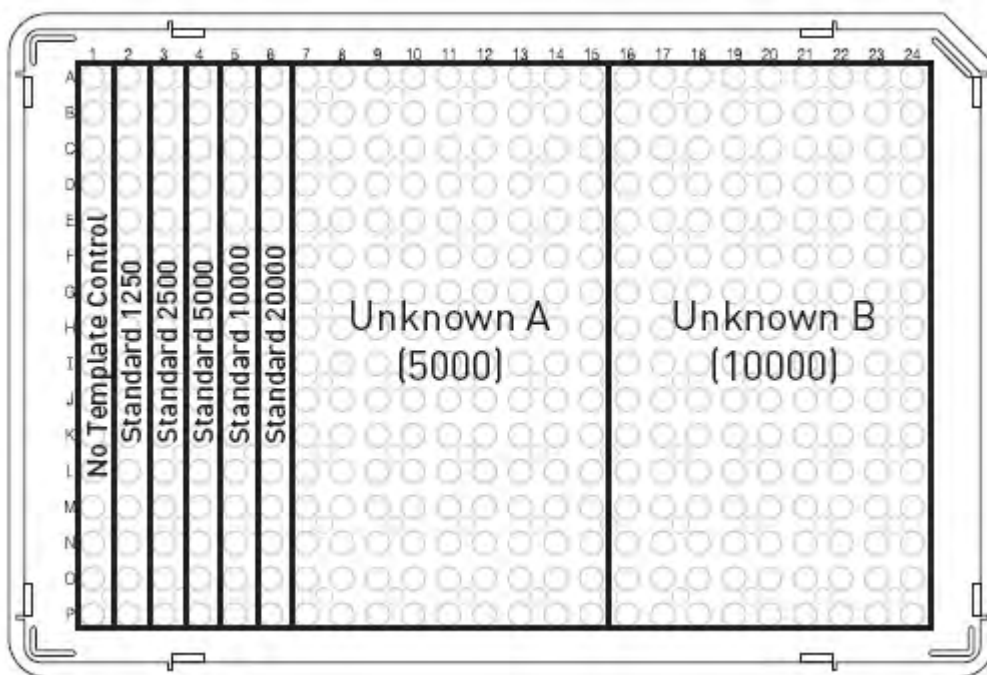

Figure 2 384-well RNase P plate layout

Array card RNase P kits

The RNase P Kits include one empty array card and eight tubes of solution. Each tube contains reaction mix (PCR master mix, RNase P primers, and FAM™-MGB dye-labeled probe) and a known concentration of human genomic DNA template.

To perform an instrument verification run, each solution is loaded into the empty array card in the arrangement shown in Figure 3. When complete, the array card contains five replicate groups of standards (200, 400, 800, 1600, and 3200 copies), two of unknown populations (800 and 1600 copies), and one that serves as a no template control (NTC).

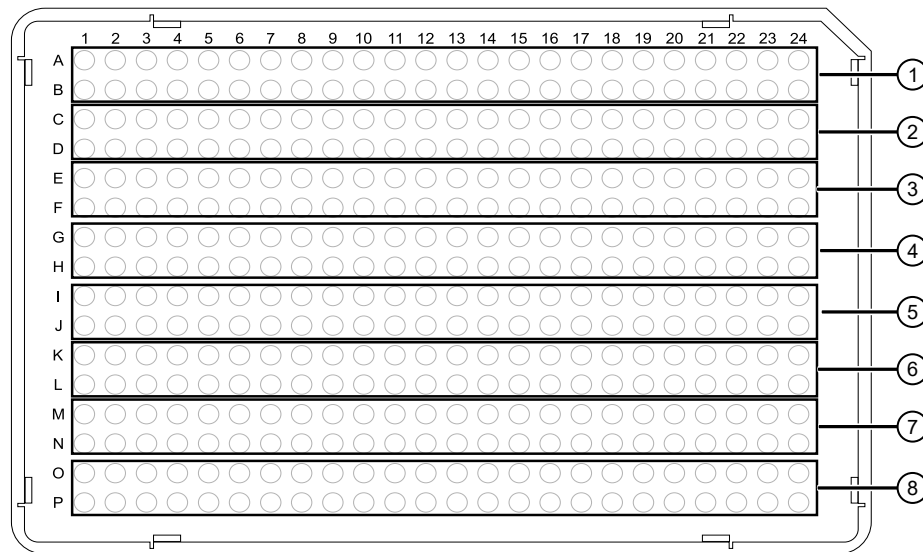

Figure 3 RNase P standards array card layout

- | | |
|-----------------------|-----------------|
| ① No Template Control | ⑤ Standard 400 |
| ② Unknown A (800) | ⑥ Standard 800 |
| ③ Unknown B (1600) | ⑦ Standard 1600 |
| ④ Standard 200 | ⑧ Standard 3200 |

Analytical performance

The software performs the same analysis of data from an instrument verification run regardless of the type of consumable used.

After the run, the software:

1. Generates a standard curve from the averaged threshold cycle (C_T) values of the replicate groups of standards.
2. Calculates the concentration of the two unknown populations using the standard curve.
3. Calculates the following to assess the QuantStudio™ 6 or 7 Flex System performance:

$$[(\text{CopyUnk}_2) - 3(\sigma_{\text{CopyUnk}_2})] > [(\text{CopyUnk}_1) + 3(\sigma_{\text{CopyUnk}_1})]$$

where:

- CopyUnk_1 = Average copy number of unknown population A
- $\sigma_{\text{CopyUnk}_1}$ = Standard deviation of unknown population A
- CopyUnk_2 = Average copy number of unknown population B
- $\sigma_{\text{CopyUnk}_2}$ = Standard deviation of unknown population B

Note: Unknown population A refers to the 5,000-copy population and unknown population B refers to the 10,000-copy population in the RNase P plate.

Installation specification

The QuantStudio™ 6 or 7 Flex System passes the installation specification if the inequality holds and the instrument successfully distinguishes between unknown populations A and B with a statistical confidence level of 99.7%.

As shown in the following table, you can omit a limited number of outlier wells from the unknown populations to meet the installation specification.

Sample block	Maximum number of outlier wells that can be removed			
	Unknown population A ^[1]	Unknown population B ^[2]	Standards (STD) ^[3]	No template controls (NTC)
96-well plate ^[4]	6	6	1	0
384-well plate	10	10	2	0
Array card ^[5]	4	4	4	0

^[1] 5,000-copy population for 384-well plates; 800-copy population for array cards.

^[2] 10,000-copy population for 384-well plates; 1,600-copy population for array cards.

^[3] Maximum number of wells that can be removed from *each* standard population.

^[4] Standard 96-well plates or Fast 96-well plates

^[5] QuantStudio™ 7 Flex System only.

Prepare the RNase P plate

Materials required

- RNase P Instrument Verification Plate
- Centrifuge with plate adapter
- Powder-free gloves
- Safety goggles

Prepare the plate

IMPORTANT! When performing the RNase P instrument verification test:

- Perform all calibrations beforehand.
- Run the RNase P plate soon after you allow the plate to thaw. Minimizing the time that the prepared plate or array card sits on the bench ensures optimal performance.
- Wear powder-free gloves and safety glasses when you prepare plates.

1. Obtain the RNase P Instrument Verification Plate from the freezer, then allow the plate to warm to room temperature (for approximately 5 minutes).

IMPORTANT! Use the RNase P plate within 30 minutes of defrosting it. Until you are ready to run the plate, store it in the dark and at ambient temperature (15–30°C). Do not remove the plate from its packaging until you are ready to run it.

2. Remove the RNase P plate from its packaging.
3. Briefly vortex and centrifuge the RNase P plate:
 - a. Vortex the plate for 5 seconds.
 - b. Centrifuge the reaction plate for 2 minutes at < 1500 rpm.

IMPORTANT! The reaction plate must be well mixed and centrifuged.

- c. Confirm that the liquid is at the bottom of each well of the reaction plate. If not, centrifuge the reaction plate again at a greater rpm and for a longer period of time.

IMPORTANT! Do not allow the bottom of the plate to become dirty. Fluids and other contaminants that adhere to the bottom of the reaction plate can contaminate the sample block and cause an abnormally high background.

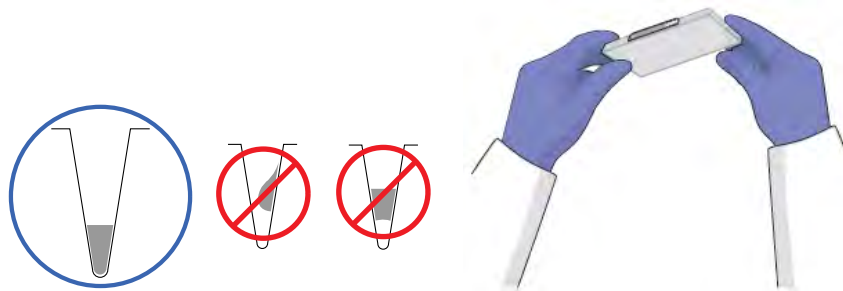

Preparing an array card for instrument verification

IMPORTANT! Perform the following procedure only if you are verifying the performance of a QuantStudio™ 7 Flex System with an array card sample block.

Required materials

- TaqMan™ Array Card Sealer
- Centrifuge with centrifuge array card carrier clips and buckets
- Powder-free gloves
- Safety goggles
- Pipettor, 200- μ L (with pipette tips)
- ViiA™ 7 Array Card RNaseP Verification Kit, includes the following components:
 - TaqMan™ Array Card
 - Eight (8) vials of RNase P detection reagents, one for each port in the TaqMan™ Array Card. Each vial contains the following reagents:
 - PCR master mix
 - RNase P primers
 - A FAM™ dye-labeled probe
 - A known concentration of human genomic DNA template

Preparing the RNase P array card

IMPORTANT! Wear powder-free gloves while preparing the array card.

1. Remove the Array Card RNase P Kit from the freezer, then allow it to warm to room temperature (for approximately 15 minutes).

IMPORTANT! You must fill and run the RNase P array card within 60 minutes of thawing the Array Card RNase P Kit.

2. Remove an array card from its box and place it on a clean, dry surface.
3. Using a permanent marker, mark the side of the empty array card with RNase P.

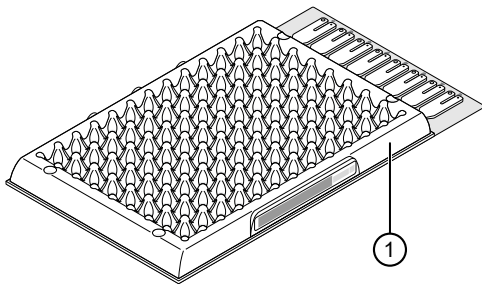

① Mark here

4. Transfer 100 μ L of each solution into the appropriate port of the array card:

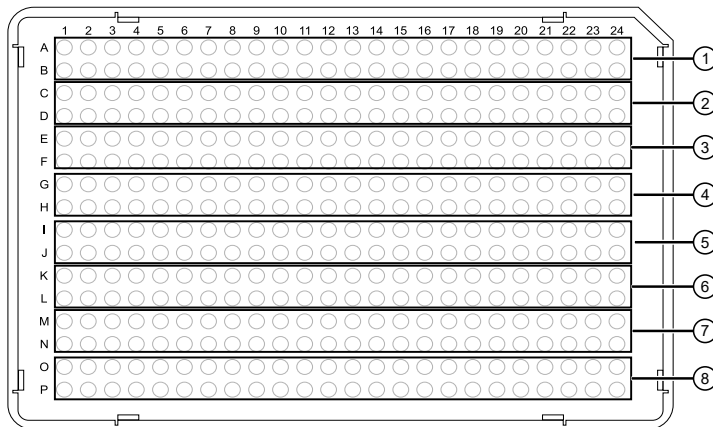

- | | |
|-----------------------|-----------------|
| ① No Template Control | ⑤ Standard 400 |
| ② Unknown A (800) | ⑥ Standard 800 |
| ③ Unknown B (1600) | ⑦ Standard 1600 |
| ④ Standard 200 | ⑧ Standard 3200 |

For each transfer:

- a. Place the array card on a lab bench, with the foil side down.
- b. Load 100 μ L of fluid into a pipette.
- c. Hold the pipette in an angled position (\sim 45 degrees) and place the tip into the fill port. The fill port is the larger of the two holes on the left side of the fill reservoir.

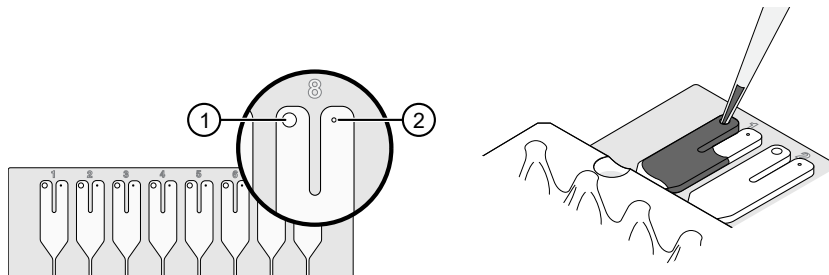

- ① Fill port
- ② Vent port

- d. Dispense the fluid so that it sweeps in and around the fill reservoir toward the vent port. Pipet the entire 100 μL into the reservoir, but *do not* go past the first stop of pipettor plunger or you may blow the solution out of the port.

IMPORTANT! Do not allow the tip to contact and possibly damage the coated foil beneath the fill port.

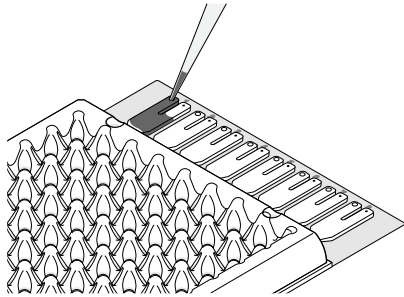

5. Centrifuge and seal the array card as explained in step 6 through step 8 in “Fill the calibration TaqMan™ Array Cards” on page 34.
6. Run the prepared array card as soon as possible after filling it.

IMPORTANT! Store the array card in a dark place until you are ready to run it. The fluorescent dyes in the array card are photosensitive. Prolonged exposure to light can diminish the fluorescence of the dye.

Run the RNase P plate or array card

1. In the QuantStudio™ Real-Time PCR Software **Home** tab, click **Instrument Console**.
2. In the **Instrument Console**, select the icon for your instrument, then click **Manage Instrument**.

Note: If the **Manage Instrument** button is inactive, add your system to the **My Instruments** group.

3. In the **Instrument Manager**, start the RNase P run:
 - a. Click  **Maintenance**, then click **RNase P Run**.
 - b. In the **RNase P Run** screen, click **Start RNase P Run**.
4. Click **Next**, then prepare for the instrument verification test as instructed.

5. At the bottom of the **Setup** tab, enter the reagent information for the RNase P plate or array card that you are using.

Reagent Information

Plate Barcode	Reagent Name	Reagent Part Number	Reagent Lot Number	Reagent Expiration Date

Check the box when the RNase P plate has been loaded, and when you have ensured you have entered all reagents information correctly

Instrument Con... 287880008 x

6. Load the RNase P plate or array card into the instrument:
 - a. From the instrument touchscreen, tap  to eject the instrument tray.
 - b. Load the plate or array card into the plate holder so that:
 - Well A1 of the plate or array card is in the top-left corner of the adapter.
 - The barcode faces the front of the instrument.

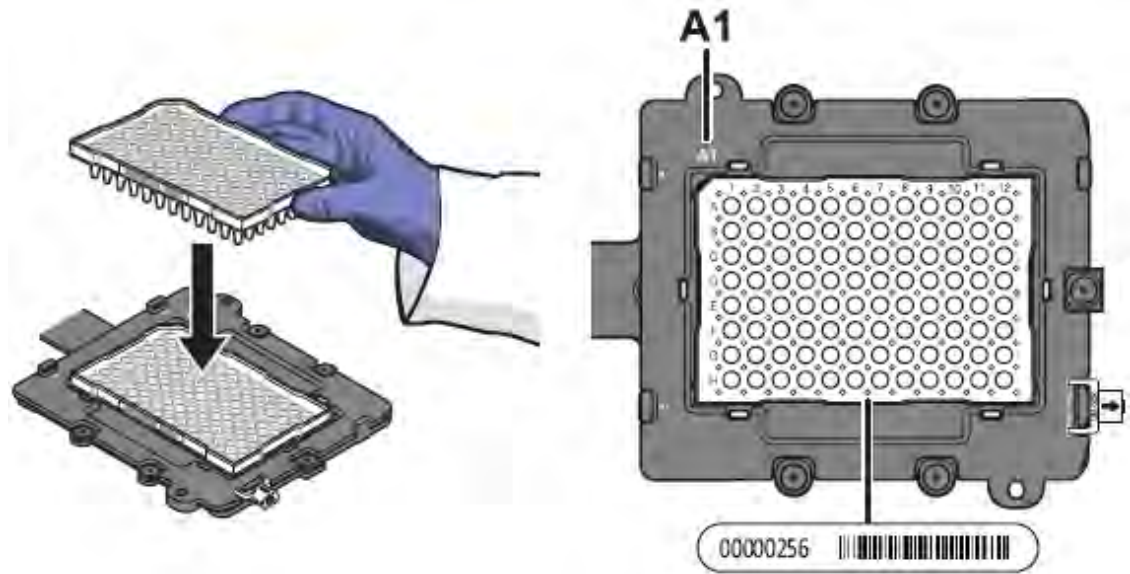

IMPORTANT! Plates and array cards should be loaded and unloaded by operators who have been warned of the moving parts hazard and have been adequately trained.

- c. From the instrument touchscreen, touch  to close the instrument tray.
7. After loading the plate or array card, start the instrument verification test:
 - a. In the **Overview** screen, select **Check the box when the RNase P plate has been loaded**, then click **Next**.
 - b. In the **Run** screen, click **Start Run** to start the test.

IMPORTANT! Do not attempt to open the access door during the run. The door is locked while the instrument is in operation.

Note: Before starting the instrument verification test, the instrument may pause (up to 10 minutes) to allow the heated cover to reach the required temperature.

8. When the run is complete and the software displays the **Analysis** screen, confirm the status of the run.

Analysis status	Action
Passed	The system passed the RNase P run.
Failed	The system failed the RNase P run. Review the data for outliers. If the run fails, the software may have included outliers that caused the initial analysis to fail. Error may cause some wells to be amplified insufficiently or not at all. These wells typically produce C_t values that differ significantly from the average for the associated replicate wells. If included in the calculations, these outlying data (outliers) can result in erroneous measurements.

9. In the **Amplification Plot**, select **Ct vs. Well** from the **Plot Type** menu.
10. Confirm the uniformity of each replicate population (controls, standards, and unknowns) on the plate or array card by comparing the groupings of C_t values:

- a. In the **Plate Layout**, select the wells containing Unknown Population A:
- b. From the plot, confirm that the C_t values of the replicate population are equivalent.

Note: The numbers on the X-axis of the plot correspond to the wells of the plate or array card. Beginning with well A1, the wells are numbered from left-to-right, and top-to-bottom.

- c. If an outlier is present in the selected population, select the corresponding well of the plate layout, then click **Omit** to remove the well from the analysis. If the total number of outliers for the replicate population exceeds the limit in the table below, repeat the test using another RNase P plate or array card.

Sample block	Maximum number of outlier wells that can be removed			
	Unknown population A ^[1]	Unknown population B ^[2]	Standards (STD) ^[3]	No template controls (NTC)
96-well plate ^[4]	6	6	1	0
384-well plate	10	10	2	0
TaqMan™ Array Card ^[5]	4	4	4	0

^[1] 5,000-copy population for 384-well plates; 800-copy population for array cards.

^[2] 10,000-copy population for 384-well plates; 1,600-copy population for array cards.

^[3] Maximum number of wells that can be removed from *each* standard population.

^[4] Standard 96-well plates or Fast 96-well plates

^[5] QuantStudio™ 7 Flex System only.

11. Repeat step 10 for each replicate population (unknowns, standards, and no template controls) on the plate or array card.
12. Review the **Results Table** for quality flags generated by the test:
 - a. Select the **Results Table** tab.
 - b. Review the **Flag** column for wells that generated quality flags.
 - c. Troubleshoot each well that generated a flag as explained in “Troubleshooting” on page 71.
 - **AMPNC**—Amplification in negative control
 - **BADROX**—Bad passive reference signal
 - **BLFAIL**—Baseline algorithm failed
 - **CTFAIL**— C_t algorithm failed
 - **EXPFAIL**—Exponential algorithm failed
 - **HIGHSD**—High standard deviation in replicate group
 - **NOAMP**—No amplification
 - **NOISE**—Noise higher than others on the consumable
 - **NOSIGNAL**—No signal in well
 - **OFFSCALE**—Fluorescence is offscale
 - **OUTLIERRG**—Outlier in replicate group
 - **SPIKE**—Noise spikes
 - **THOLDFAIL**—Thresholding algorithm failed
13. If you omitted outliers, click **Reanalyze** to analyze the run.
If the status of the RNase P Run is **Failed** after performing step 8–12, repeat the RNase P test using a different RNase P plate or array card. If the problem persists, contact Technical Support.
14. Review the standard curve:
 - a. Select the **Standard Curve** tab.
 - b. Click the upper-left corner of the **Plate Layout** to select all wells.
 - c. Confirm that the R^2 value is ≥ 0.990 .

If the R^2 value is < 0.990 , repeat the RNase P test using a different RNase P plate or array card. If the problem persists, contact Technical Support.
15. In the **Analysis** screen, click **Next**, remove the plate or array card when the instrument ejects the tray arm, then discard the consumable.



WARNING! PHYSICAL INJURY HAZARD. During instrument operation, the plate or array card can reach 100°C. Before removing the consumable, be sure to wait until it reaches room temperature.

Note: If the instrument does not eject the plate or array card, remove it as explained in “Troubleshooting” on page 71.

16. Click **Finish**, then click **Yes** when prompted to save the test.
17. *(Optional)* Click **Print Report** in the upper right corner of the screen to print a summary of the RNase P test results for your records.

Troubleshooting

The tables in this section describe how to troubleshoot failed calibrations and RNase P instrument verification tests.

Table 2 ROI calibration troubleshooting

Problem/symptom	Possible cause	Action
ROI calibration failed. <ul style="list-style-type: none"> • ROI image is blurry • ROI image is faint 	<ul style="list-style-type: none"> • Plate or array card was centrifuged insufficiently. • Plate or array card contains old or insufficient reagents. • The sample block or heated cover may not be seated correctly. 	<p>CAUTION! PHYSICAL INJURY HAZARD. During operation, the sample block can reach 100°C. Before removing the plate or array card, wait until the block reaches room temperature.</p> <ol style="list-style-type: none"> 1. Unload the instrument and confirm that you loaded the correct plate or array card. If not, perform the calibration again using the correct type of consumable. 2. View the wells of the plate or array card. If the liquid in the wells is not: <ul style="list-style-type: none"> • At the bottom of the wells, centrifuge the plate or array card for a longer time, then repeat the calibration. • Equivalent in volume, the plate or array card is not sealed properly and the reagents have evaporated. Discard the consumable and run another. 3. If the calibration plate or array card appears to be normal, discard it and run another. 4. If the calibration fails again, check the sample block and heated cover positions: <ol style="list-style-type: none"> a. Power off and unplug the instrument. Wait 15 minutes, then open the access door. b. Firmly push the sample block and the heated cover toward the back of the instrument to confirm that they are seated correctly. <p>IMPORTANT! Align the arrows on the front handle of the heated cover as shown. If the arrows are not aligned, push the heated cover into the instrument until the handle locks into place.</p> <p>IMPORTANT! Confirm that the indicator on the left side of the sample block is positioned behind the red line on the instrument rail. If not, push the sample block into the instrument until it is seated correctly.</p> c. Repeat the calibration. 5. If the calibration fails again, contact Technical Support. 

Table 2 ROI calibration troubleshooting (continued)

Problem/symptom	Possible cause	Action
Instrument does not eject the ROI plate or array card (it is stuck within the instrument).	The adhesive cover may have adhered the plate or array card to the heated cover.	Remove the plate or array card from the instrument as explained in “Remove a plate stuck within the instrument” on page 81.
Instrument malfunction.	Multiple possible causes.	Contact your local Thermo Fisher Scientific Field Service Office.

Table 3 Background calibration troubleshooting

Problem/symptom	Possible cause	Action
Background calibration failed.	<ul style="list-style-type: none"> • Plate or array card was centrifuged insufficiently. • Plate or array card contains old or insufficient reagents. • One or more wells of the background plate or array card produced spectra that exceed the maximum limit for the instrument. 	 CAUTION! PHYSICAL INJURY HAZARD. During operation, the sample block can reach 100°C. Before removing the plate or array card, wait until the block reaches room temperature. <ol style="list-style-type: none"> 1. Unload the QuantStudio™ 6 or 7 Flex System and confirm that you loaded the correct plate or array card into the instrument. If not, perform the calibration again using the correct type of consumable. 2. View the wells of the plate or array card. If the liquid in the wells of the consumable is not: <ul style="list-style-type: none"> • At the bottom of the wells, centrifuge the plate or array card for a longer time, then repeat the calibration. • Equivalent in volume, the plate or array card is not sealed and the reagents have evaporated. Discard the consumable and run another. 3. If the calibration plate or array card appears to be normal, discard it and run another. 4. If the calibration fails again, determine the source of the contamination, as explained in “How to identify contamination” on page 80.
Instrument does not eject the background plate or array card (it is stuck within the instrument).	The adhesive cover may have adhered the plate or array card to the heated cover within the instrument.	Remove the plate or array card from the instrument as explained in “Remove a plate stuck within the instrument” on page 81.
Instrument malfunction.	Multiple possible causes.	Contact your local Thermo Fisher Scientific Field Service Office.

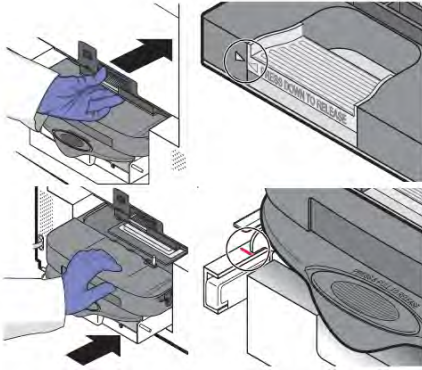
Table 4 Uniformity calibration troubleshooting

Problem/symptom	Possible cause	Action
Uniformity calibration failed.	<ul style="list-style-type: none"> • Plate or array card was centrifuged insufficiently. • Plate or array card contains old or insufficient reagents. • Abnormally low spectra across all wells of the plate or array card. 	<p> CAUTION! PHYSICAL INJURY HAZARD. During operation, the sample block can reach 100°C. Before removing the plate or array card, wait until the block reaches room temperature.</p> <ol style="list-style-type: none"> 1. Unload the QuantStudio™ 6 or 7 Flex System and confirm that you loaded the correct plate or array card into the instrument. If not, perform the calibration again using the correct type of consumable. 2. Unload the QuantStudio™ 6 or 7 Flex System and view the wells of the plate or array card. If the liquid in the wells of the consumable is not: <ul style="list-style-type: none"> • At the bottom of the wells, centrifuge the plate or array card for a longer time, then repeat the calibration. • Equivalent in volume, the plate or array card is not sealed and the reagents have evaporated. Discard the consumable and run another. 3. If the calibration plate or array card appears to be normal, discard it and run another. 4. If the calibration fails again, contact Technical Support.
	One or more wells produced spectra that deviate significantly from the rest of the plate or array card.	<ol style="list-style-type: none"> 1. While viewing the calibration data in the Analysis screen, locate the well(s) with abnormal signal in the Plate Layout tab. 2. Rotate the plate or array card 180°, then perform the calibration again. 3. Determine the location of the contaminated wells again. If the position(s) of the well(s) identified in the steps above are: <ul style="list-style-type: none"> • Identical – The sample block is contaminated. Decontaminate the sample block. • Reversed – The ROI plate or array card is contaminated. Discard the consumable, then perform the uniformity calibration using a new ROI plate or array card. 4. If the calibration fails again, contact Technical Support.

Table 4 Uniformity calibration troubleshooting (continued)

Problem/symptom	Possible cause	Action
Instrument does not eject the ROI plate or array card (the consumable is stuck within the instrument).	The adhesive cover may have adhered the plate or array card to the heated cover within the instrument.	Remove the plate or array card from the instrument as explained in “Remove a plate stuck within the instrument” on page 81.
Instrument malfunction.	Multiple possible causes.	Contact your local Thermo Fisher Scientific Field Service Office.

Table 5 Dye calibration troubleshooting

Problem/symptom	Possible cause	Action
Dye calibration failed. One or more raw spectra are at or below the detectable threshold for the calibration.	<ul style="list-style-type: none"> Dye plate or array card was centrifuged insufficiently. Dye plate or array card contains old or insufficient reagents. 	 CAUTION! PHYSICAL INJURY HAZARD. During operation, the sample block can reach 100°C. Before removing the plate or array card, wait until the block reaches room temperature. <ol style="list-style-type: none"> Unload the QuantStudio™ 6 or 7 Flex System and view the wells of the plate or array card. If the liquid in the wells of the consumable is not: <ul style="list-style-type: none"> At the bottom of the wells, centrifuge the plate or array card for a longer time, then repeat the calibration. Equivalent in volume, the plate or array card is not sealed and the reagents have evaporated. Discard the consumable and run another. If the dye calibration plate or array card appears to be normal, discard it and run another. If the problem persists, contact Technical Support.
<ul style="list-style-type: none"> Spectra contain peaks in more than one filters. One or more raw spectra exceed the maximum limit for the instrument. 	Fluorescent contaminants are present on the sample block or dye plate or array card.	Confirm that contaminants are not present by performing a background calibration. If the background calibration does not show sample block contamination, the dye plate or array card may be contaminated.
Instrument does not eject the dye plate or array card (the consumable is stuck within the instrument).	The adhesive cover may have adhered the plate or array card to the heated cover within the instrument.	Remove the plate or array card from the instrument as explained in “Remove a plate stuck within the instrument” on page 81.
Instrument malfunction.	Multiple possible causes.	Contact your local Thermo Fisher Scientific Field Service Office.

Table 6 Normalization calibration troubleshooting

Problem/symptom	Possible cause	Action
Normalization calibration failed.	Abnormally low spectra across all wells of the plate or array card.	 CAUTION! PHYSICAL INJURY HAZARD. During operation, the sample block can reach 100°C. Before removing the plate or array card, wait until the block reaches room temperature. <ol style="list-style-type: none"> 1. Unload the QuantStudio™ 6 or 7 Flex System and confirm that you loaded the correct plate or array card into the instrument. If not, perform the calibration again using the correct consumable. 2. If you are using the correct plate or array card, perform the calibration again using a different normalization consumable. 3. If the calibration fails again, contact Thermo Fisher Scientific Field Service Office.
	One or more wells produced spectra that deviate significantly from the rest of the plate or array card.	<ol style="list-style-type: none"> 1. While viewing the calibration data in the Analysis screen, locate the well(s) with abnormal signal in the Plate Layout tab. 2. Rotate the plate or array card 180°, then perform the calibration again. 3. Determine the location of the contaminated wells again. If the position(s) of the well(s) identified in the steps above are: <ul style="list-style-type: none"> • Identical: The sample block is contaminated. Decontaminate the sample block. • Reversed: The normalization plate or array card is contaminated. Discard the consumable, then perform the normalization calibration using a new normalization plate or array card. 4. If the calibration fails again, contact your local Thermo Fisher Scientific Field Service Office.
Instrument does not eject the normalization plate or array card (it is stuck within the instrument).	The adhesive cover may have adhered the plate or array card to the heated cover within the instrument.	Remove the plate or array card from the instrument as explained in “Remove a plate stuck within the instrument” on page 81.
Instrument malfunction.	Multiple possible causes.	Contact your local Thermo Fisher Scientific Field Service Office.

Table 7 RNase P test troubleshooting

Problem/symptom	Possible cause	Action
RNase P plate or array card verification run failed.	<ul style="list-style-type: none"> • Contamination • Defective seal • Inaccurate fluid transfer during plate or array card manufacturing • Insufficient centrifugation 	 <p>CAUTION! PHYSICAL INJURY HAZARD. During operation, the sample block can reach 100°C. Before removing the plate or array card, wait until the block reaches room temperature.</p> <ol style="list-style-type: none"> 1. Unload the RNase P plate or array card from the instrument. 2. Hold the plate or array card up to a light source, and confirm that all wells contain the same volume of fluid. If there are differences in fluid volumes, check the heat seal of the wells with lower volumes for signs of damage or evaporation. Compare the position of the wells that have lower volumes with the outliers that you have removed from the plate or array card. If the well positions coincide, the heat seal on the consumable may be defective, resulting in the evaporation of the associated samples. 3. Contact Thermo Fisher Scientific to order a replacement RNase P plate or array card. If the replacement consumable fails, contact Technical Support for assistance.
Instrument does not eject the RNase P plate or array card (the consumable is stuck within the instrument).	Adhesive cover may have adhered the plate or array card to the heated cover within the instrument.	Remove the plate or array card from the instrument as explained in “Remove a plate stuck within the instrument” on page 81.
Negative control well displays the AMPNC flag, indicating that the well amplified.	Contamination in one or more PCR reaction components contained in the negative control well.	Contact Thermo Fisher Scientific to order a replacement RNase P plate or array card kit. If the replacement RNase P consumable fails, contact Technical Support for assistance.

Table 7 RNase P test troubleshooting (continued)

Problem/symptom	Possible cause	Action
Well displays the BADROX™ flag, indicating that the passive reference signal is unacceptable for the normalization of the reporter dye signal.	<ul style="list-style-type: none"> • Droplets on the sides of the wells • Improper sealing or seal leaks • Condensation on the plate or array card 	<p>If a well is flagged, confirm the results:</p> <ol style="list-style-type: none"> 1. Select the flagged well(s) in the plate layout or well table. 2. View the amplification plot (R_n vs. Cycle), and review the data in the C_t region for abnormalities. 3. Examine the plate or array card to check for condensation and/or inconsistent reaction volumes. 4. Contact Thermo Fisher Scientific to order a replacement RNase P plate or array card. Repeat the test and make sure to properly centrifuge the RNase P consumable. If the replacement RNase P plate or array card fails, contact Technical Support for assistance.
Well displays the BLFAIL flag, indicating that the software cannot calculate the best fit baseline for the data.	<ul style="list-style-type: none"> • Amplification too late • No amplification 	<p>If a well is flagged, confirm the results:</p> <ol style="list-style-type: none"> 1. Select the flagged well(s) in the plate layout or well table. 2. View the amplification plot (R_n vs. Cycle and DR_n vs. Cycle) and check for early, late, low, or no amplification. 3. Contact Thermo Fisher Scientific to order a replacement RNase P plate or array card. Repeat the test, making sure to properly seal and centrifuge the RNase P plate or array card. If the replacement RNase P plate or array card fails, contact Technical Support for assistance.
<ul style="list-style-type: none"> • Well displays the CTFAIL flag, indicating that the software cannot calculate the threshold cycle (C_t). • Well displays the EXPFAIL flag, indicating that the software cannot identify the exponential region of the amplification plot. 	<ul style="list-style-type: none"> • Amplification too early • Amplification too late • Low amplification • No amplification 	
Well displays the HIGHSD flag, indicating that the C_t standard deviation for the replicate group exceeds the current flag setting.	<ul style="list-style-type: none"> • Droplets on the sides of the wells • Improper sealing or seal leaks • Condensation on the plate or array card • Inconsistent volumes across the plate or array card 	<p>If a well is flagged, confirm the results:</p> <ol style="list-style-type: none"> 1. Select the flagged well(s) and the associated replication group(s) in the plate layout or well table. 2. View the amplification plot (R_n vs. Cycle), and review the data for abnormalities. 3. Hold the plate or array card up to a light source, and check for condensation or evaporation. If there are differences in fluid volumes, check the heat seal of the wells with lower volumes for signs of damage or evaporation.

Table 7 RNase P test troubleshooting (continued)

Problem/symptom	Possible cause	Action
Well displays the NOAMP flag, indicating that the sample did not amplify.	<ul style="list-style-type: none"> • Missing template • Excitation source in the instrument stopped functioning 	<p>4. Contact Thermo Fisher Scientific to order a replacement RNase P plate or array card. Repeat the test, and make sure to properly centrifuge the RNase P consumable. If the replacement RNase P plate or array card fails, contact Technical Support for assistance.</p>
Well displays the NOISE flag, indicating that the well produced more noise in the amplification plot than other wells on the plate or array card.	<ul style="list-style-type: none"> • Droplets on the sides of the wells • Improper sealing or seal leaks • Condensation on the plate or array card. 	
Well displays the NOSIGNAL flag, indicating that the well produced very low or no fluorescence signal.	Missing reaction mix resulting from pipetting error.	<p>If a well is flagged, confirm the results:</p> <ol style="list-style-type: none"> 1. Consider omitting the well from the analysis. 2. Note the location for each flagged well, and check each corresponding well in the plate or array card for evaporation or low reaction volume. 3. Contact Thermo Fisher Scientific to order a replacement RNase P plate or array card. If the replacement RNase P consumable fails, contact Technical Support for assistance
Well displays the OFFSCALE flag, indicating that the fluorescence signal for one or more dyes in the well exceeds the instrument's maximum detectable range for one or more cycles.	<ul style="list-style-type: none"> • Fluorescent contaminant on the plate or array card or sample block • Fluorescent contaminant in the reaction 	<ol style="list-style-type: none"> 1. Perform a background calibration. If you detect fluorescent contamination, decontaminate the sample block. 2. Contact Thermo Fisher Scientific to order a replacement RNase P plate or array card. If the replacement consumable fails, contact Technical Support for assistance
Well displays the OUTLIERRG flag, indicating that the C_t of the well deviates significantly from C_t values in the associated replicate group (only the outlier is flagged).	<ul style="list-style-type: none"> • Contamination • Improper sealing or seal leaks 	<ol style="list-style-type: none"> 1. Decontaminate the work area and pipettors. 2. Contact Thermo Fisher Scientific to order a replacement RNase P plate or array card. Repeat the test and make sure that the RNase P consumable is properly sealed. If the replacement RNase P plate or array card fails, contact Technical Support for assistance.
Well displays the SPIKE flag, indicating that the amplification curve contains one or more data points inconsistent with the other points in the curve.	<ul style="list-style-type: none"> • Bubbles in the reaction • Evaporation during the denaturation step because of improper sealing or seal leaks 	Contact Thermo Fisher Scientific to order a replacement RNase P plate or array card. Repeat the test, and make sure to properly centrifuge the RNase P consumable. If the replacement RNase P plate or array card fails, contact Technical Support for assistance.

Table 7 RNase P test troubleshooting (continued)

Problem/symptom	Possible cause	Action
Well displays the THOLDFAIL flag, indicating that the software cannot calculate the threshold.	<ul style="list-style-type: none"> • Amplification too early • Amplification too late • Low amplification • No amplification 	<p>If a well is flagged, confirm the results:</p> <ol style="list-style-type: none"> 1. Select the flagged well(s) in the plate layout or well table. 2. View the amplification plot (R_n vs. Cycle and DR_n vs. Cycle), and check for early, late, low, or no amplification. 3. Contact Thermo Fisher Scientific to order a replacement RNase P plate or array card. If the replacement RNase P consumable fails, contact Technical Support for assistance.
Instrument malfunction.	Multiple possible causes	Contact your local Thermo Fisher Scientific Field Service Office.

How to identify contamination

Signals that exceed the limit of normal background fluorescence may indicate fluorescent contaminants on the calibration plate or array card or the sample block. Common contaminants include ink residue from permanent pens, powder from disposable gloves, and dust.

To identify and resolve a possible contamination problem:

1. While viewing the background calibration data in the Analysis screen, select the QC tab to review the list of wells that failed the quality check.
2. Eject the background plate or array card from the instrument, rotate the plate 180°, then perform the background calibration again.
3. Determine the location of the contaminated wells again as in step 1.
If the position(s) of the contaminated well(s) in the steps above are:
 - **Identical** – The sample block is contaminated. Decontaminate the sample block as explained in “Decontaminate the sample block” on page 97.
 - **Reversed** – The background plate or array card is contaminated. Discard it, then perform the background calibration using a new background consumable.
4. If the calibration fails after you replace the background plate or array card and decontaminate the sample block, contact Technical Support.

Remove a plate stuck within the instrument

If the QuantStudio™ 6 or 7 Flex System does not eject a plate after you touch  on the touchscreen, the adhesive cover of the plate may have adhered it to the heated cover within the instrument. If so, you can remove the plate from the instrument as follows.

1. Power off the instrument. Wait 15 minutes, then power on the instrument and eject the plate.
2. If the plate does not eject, power off and unplug the instrument, then open the access door.
3. While wearing powder-free gloves, reach into the instrument and remove the plate from the heated cover, then close the access door.
4. Perform a background calibration to confirm that the sample block has not been contaminated.



Manual instrument operation

- Overview of instrument touchscreen functions 82
- Operate the instrument from the touchscreen 83
- Maintain the instrument from the touchscreen 87
- Administrate the instrument from the touchscreen 90

Note: This appendix describes how to operate the QuantStudio™ 6 and 7 Flex Systems manually using the touchscreen interface. Although the QuantStudio™ 6 and 7 Flex Systems can be used without an Ethernet connection to a computer, the touchscreen allows you to perform only a subset of the total instrument functions.

Overview of instrument touchscreen functions

The QuantStudio™ 6 and 7 Flex Systems feature a touchscreen interface that you can use to transfer data, manage instrument settings, and configure the instrument for network use. The touchscreen does not provide access to all instrument functions. Features such as analyzing experiments, instrument calibration, and remote notification are available only through the QuantStudio™ Real-Time PCR Software.

The following table summarizes the functions that are available from the touchscreen.

Category	Function	Available in secure mode? ^[1]
Operational ^[2]	Create experiments from templates	No
	Run experiments	
	Transfer and delete experiments, templates, and results to/from a USB drive	
Maintenance ^[3]	Back up and restore the instrument settings	Yes
	Perform an instrument self test	
	Install and record a new lamp	
	Update the instrument firmware	
Administration ^[4]	Define the date and time	
	Define the instrument settings	

(continued)

Category	Function	Available in secure mode? ^[1]
Administration ^[4]	Define the network settings	Yes
	Define the maintenance reminders	
	Define the system shortcuts	
	Enable or disable instrument security	
	Review the instrument statistics	
	Review the instrument version information	
	View the system log	

^[1] See “Enable or disable instrument security” on page 95.

^[2] Tasks for users responsible for day-to-day use of the instrument.

^[3] Tasks for users who maintain the instrument.

^[4] Tasks for systems administrators or for information technology personnel.





Operate the instrument from the touchscreen

The touchscreen provides limited control of the instrument to run experiments and transfer data. You can perform the following functions from the touchscreen to operate the instrument without using the QuantStudio™ Real-Time PCR Software:



- Create an experiment from a template (see page 83)
- Run an experiment (see page 84)
- Transfer experiments, templates, and results data (see page 85)

Note: If the instrument is operating in secure mode, users can only open and close the side door (see “Enable or disable instrument security” on page 95).



Create an experiment from a template

1. If necessary, download the experiment template to the QuantStudio™ 6 or 7 Flex Real-Time PCR System (see “Transfer experiments from a USB drive” on page 86).
2. If the instrument is in standby, tap the instrument touchscreen to activate it, then tap .
3. In the main menu, tap  **View Templates**.
4. In the **View Templates** screen, tap a template, then tap **+ New**.
To view the parameters of a template, select the desired template, then tap  **View**. When finished, tap  to return to the **View Templates** screen.

Note: You cannot modify the experiment parameters of a template.

5. In the **Create New Experiment** screen, tap each field to set the following items:
 - Tap the **New Experiment Name** field and use the keypad to enter a name (up to 100 characters) for the experiment.
 - Tap the **Save to Folder** field to open the **Select Folder** screen.
 - Tap the **Reaction Volume** field to enter a reaction volume in μL .
 - (Optional) Tap the **Barcode Number** field to enter a barcode, and tap the **Notes** field to enter notes (up to 200 characters) about the experiment.
6. When finished, select one of the following options:
 - Tap  **Save & Exit**.
 - Tap  **Save & Start Run** to proceed to the **Start Run** screen.



Run an experiment

1. If the instrument is in standby, tap the QuantStudio™ 6 or 7 Flex Real-Time PCR System touchscreen to activate it, then tap .
2. In the main menu, tap .
3. When the side door opens, load the appropriate plate or array card.

Ensure that the consumable is properly aligned in the holder.

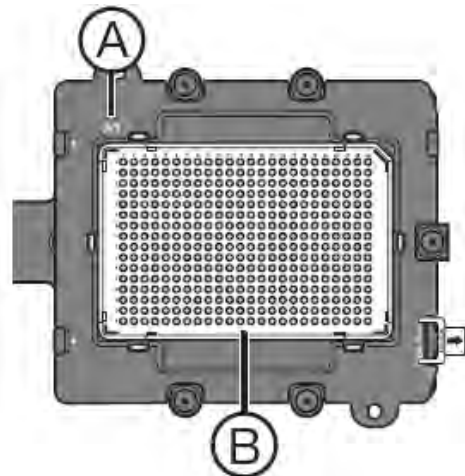
 - **(A)** Load 96/384-well plates with the A1 position at the top-left corner of the plate adapter.
 - **(B)** Load both plates and array cards with the barcode facing the front of the instrument.
4. In the main menu, tap **Browse Experiments**.
5. In the **Experiments** screen, touch the desired experiment, then tap one of the following options:



Option	Description
 Start Run	Start the run immediately, then go to step 10.
 View/Edit	View or edit the experiment before starting the run.

6. Modify the experiment parameters as needed.
 - Add a stage or step to the thermal profile, tap the stage or step to the left of where you want to add the stage or step, then tap **Add**.
 - Add a melt curve to the end of the thermal profile, tap **Add Melt Curve**.
 - Change the time or temperature of a stage or step, touch the time/temperature field of the stage or step, modify the settings as desired, then tap **Close**.
 - Change the cycle parameter of a stage, tap the cycle field, modify the setting as desired, then tap **Close**.
 - Delete a stage or step from the thermal profile, tap the stage or step you want to remove, then tap **Delete**.
7. When finished modifying the parameters, tap **Save**.
8. In the **Save Experiment** screen, tap each field to set the experiment, name, reaction volume, barcode, and any additional information to save to the experiment
9. When finished, tap **Save & Start Run** to start the experiment.
10. In the **Start Run** screen, tap each field as needed to modify the associated parameter, then tap **Start Run Now** to start the experiment.

Note: When the run is complete, tap **Unload** to unload the plate. You can download the experiment results to a computer if the QuantStudio™ 6 or 7 Flex Real-Time PCR System is connected to a network, or you can copy the data to a USB drive (see “Transfer experiments, templates, and results data” on page 85).

Transfer experiments, templates, and results data

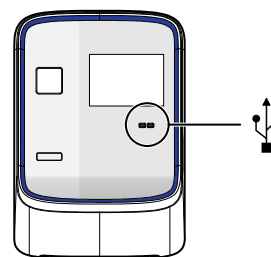

You can transfer experiments, templates, and results data to/from the QuantStudio™ 6 and 7 Flex Systems using a USB flash drive. Before transferring data, you must plug the drive into the USB port below the touchscreen.







IMPORTANT! Do not use the USB ports on the rear panel of the QuantStudio™ 6 and 7 Flex Systems. The rear USB ports are only for use by Thermo Fisher Scientific personnel to service the instrument.

Transfer templates from a USB drive





1. Plug a USB drive into the USB port below the touchscreen.
2. If the instrument is in standby, touch the QuantStudio™ 6 or 7 Flex System touchscreen to activate it, then press **Power**.
3. In the Main Menu, touch **View Templates**.

4. In the Browse Experiments screen, select the template:
 - a. Touch , then touch **USB**.
 - b. Touch the desired template, then touch  **Save**.
5. In the Save Experiment As screen, set the name for the file.
 - a. Touch the New Template Name field, then enter a name for the copied file.
 - b. Touch the Save to Folder field, then select the folder to receive the file.
 - c. Touch **Save**.
6. Touch  to return to the Main Menu.
7. Unplug the USB drive.

Transfer experiments from a USB drive

1. Plug a USB drive into the USB port below the touchscreen.
2. If the instrument is in standby, touch the QuantStudio™ 6 or 7 Flex System touchscreen to activate it, then press .
3. In the Main Menu, touch **Browse Experiments**.
4. In the Browse Experiments screen, select the experiment:
 - a. Touch , then touch **USB**.
 - b. Touch the desired experiment, then touch  **Save**.
5. In the Save Experiment As screen, touch the experiment that you want to transfer to the USB drive, then touch **Save**.
6. Touch  to return to the Main Menu.
7. Unplug the USB drive.

Copy experiment results to a USB drive



1. Plug a USB drive into the USB port below the touchscreen.
2. If the instrument is in standby, touch the QuantStudio™ 6 or 7 Flex System touchscreen to activate it, then press .
3. From the Main Menu of the instrument touchscreen, touch **Collect Results**.
4. From the list of experiments, touch the experiment(s) of interest or touch  **Select All**.
5. Touch  **Save to USB**.
6. From the Copy Results To USB screen, check that the name of the USB drive is correct to ensure that it is mounted, then touch  **Save to USB**.

7. Touch  to return to the Main Menu.
8. Unplug the USB drive.

Note: After the results from a completed run have been collected, the corresponding experiment displays “Collected” and it can be deleted.

Delete results

Once you have collected results from the QuantStudio™ 6 or 7 Flex System, you can use the touchscreen to delete the files from the instrument hard drive.

1. From the Main Menu of the instrument touchscreen, touch **Collect Results**.
2. From the list of experiments, touch the experiment(s) of interest, then touch  **Delete**.
3. When asked to confirm the deletion, touch **OK**.
4. Touch  to return to the Main Menu.

Maintain the instrument from the touchscreen

The touchscreen provides access to a few maintenance functions that cannot be accessed remotely from the QuantStudio™ Real-Time PCR Software. Unlike the maintenance performed using the QuantStudio™ Real-Time PCR Software, some of the touchscreen functions are not part of the recommended maintenance schedule. The frequency that you perform them depends on your laboratory policies.

- Back up and restore the instrument settings (see page 87)
- Perform an instrument self-test (see page 89)
- Update the instrument firmware (see page 89)

Note: The touchscreen does not provide access to all instrument functions. Features such as instrument calibration and remote notification are available only through the QuantStudio™ Real-Time PCR Software.

Back up and restore the instrument settings

You can use the QuantStudio™ 6 or 7 Flex System touchscreen to back up the instrument settings (icon, standby time-out, and cover idle temperature), and some network settings (the Autodiscovery and Smart Monitoring options). If the QuantStudio™ 6 or 7 Flex Instrument settings are reset, you can restore the settings using the backup.

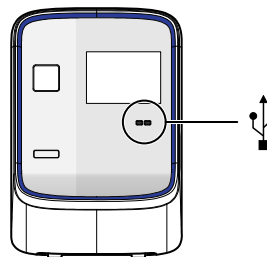

Note: The backup feature can be used as an administrative tool to manage QuantStudio™ 6 and 7 Flex Systems. You can use the feature to create a standard “image” for a QuantStudio™ 6 or 7 Flex Instrument that can then be restored on other instruments to bypass the manual setup process.

The QuantStudio™ 6 and 7 Flex Systems back up to and restores instrument settings from a USB flash drive. Before backing up or restoring settings, you must plug the drive into one of the USB ports below the touchscreen.



IMPORTANT! Do not use the USB ports on the rear panel of the QuantStudio™ 6 and 7 Flex Systems. The rear USB ports are for use by Thermo Fisher Scientific personnel to service the instrument.

Back up the instrument settings

1. Plug a USB drive into the USB port below the touchscreen.
2. From the Main Menu of the instrument touchscreen, touch **Tools**, then touch **Backup Settings**.
3. From the Backup Settings screen, touch  **Backup**.
4. Wait for the backup to complete, then touch  to return to the Main Menu.
5. Unplug the USB drive.

Note: For administrative purposes, you can reuse the instrument settings saved to the USB drive to configure more than one QuantStudio™ 6 or 7 Flex System. Note that you must configure the network settings for each instrument individually.

Restore the instrument settings

1. Plug the USB drive that contains the instrument settings into the USB port below the touchscreen.
2. From the Main Menu of the instrument touchscreen, touch **Tools**, then touch **Restore Settings**.
3. From the Restore Settings screen, select the settings to restore:
 - a. Touch the settings that you want to restore from the list.
 - b. Touch  **Restore** to upload the instrument settings from the USB drive.

IMPORTANT! Do not remove the USB drive from the QuantStudio™ 6 or 7 Flex System until instructed.

Note: Alternatively, touch **Restore Default Settings** to restore the QuantStudio™ 6 or 7 Flex System to the factory settings.

4. After the QuantStudio™ 6 or 7 Flex System restarts, unplug the USB drive.

Perform an instrument self test

You can use the QuantStudio™ 6 or 7 Flex System touchscreen to perform a comprehensive self test of the QuantStudio™ 6 or 7 Flex System subsystems. After the self test is complete, the QuantStudio™ 6 or 7 Flex System generates two files that provide a detailed summary of the instrument condition and function. In the event of a problem, you can save the results files to a USB drive and email them to Technical Support for a diagnosis.

Note: We recommend running the self test as part of regular maintenance to ensure optimal performance of the QuantStudio™ 6 or 7 Flex System.

1. From the Main Menu of the instrument touchscreen, touch **Tools**, then touch **Run Self Test**.
2. From the Self Test screen, touch **Start Self Test**, then wait for the test to complete.
3. (Optional) When the QuantStudio™ 6 or 7 Flex System completes the self test, save the results to a USB drive:
 - a. Plug a USB drive into the USB port below the touchscreen.

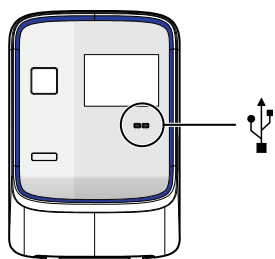

IMPORTANT! Do not use the USB ports on the rear panel of the QuantStudio™ 6 and 7 Flex Systems. The rear USB ports are for use by Thermo Fisher Scientific personnel to service the instrument.

- b. Touch  **Save**.

IMPORTANT! Do not remove the USB drive from the QuantStudio™ 6 or 7 Flex System until instructed.

- c. When the QuantStudio™ 6 or 7 Flex System finishes writing the results to the USB drive, touch **OK**, then remove the USB drive.
4. Touch  to return to the Main Menu.

Update the instrument firmware



You can download the QuantStudio™ 6 and 7 Flex Systems firmware updates at [thermofisher.com/qpcrsoftware](https://www.thermofisher.com/qpcrsoftware). After obtaining a firmware update, transfer the update to the system using a USB drive.

1. Download the firmware update:
 - a. Go to [thermofisher.com/qpcrsoftware](https://www.thermofisher.com/qpcrsoftware).

- b. In the **Real-Time PCR** section, select **Applied Biosystems™ QuantStudio™ 6 and 7 Flex Real-Time PCR Systems**.
 - c. In the **Software Downloads** page, click **Updates - Patches**.
 - d. Download the firmware to a USB drive.
2. Plug a USB drive into the USB port below the touchscreen.

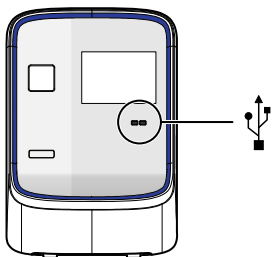
IMPORTANT! Do not use the USB ports on the rear panel of the QuantStudio™ 6 and 7 Flex Systems. The rear USB ports are for use by Thermo Fisher Scientific personnel to service the instrument.



3. If the instrument is in standby, tap the touchscreen to activate it, then tap .
4. In the main menu, tap **Tools**, then tap  **Upgrade Firmware**.
5. In the **Upgrade Firmware** screen, select the update package, then tap  **Upgrade Firmware**. Allow the system to complete the upgrade.

IMPORTANT! Do not remove the USB drive from the system until you are instructed to do so.

6. After the upgrade is complete and the system reboots, confirm the upgrade success:
 - a. Unplug the USB drive.
 - b. Tap **Settings**, then tap **About this instrument** to view the software version number to confirm that the firmware has been upgraded.

Administrate the instrument from the touchscreen

The touchscreen provides access to several administrative functions that you can use to integrate the QuantStudio™ 6 and 7 Flex Systems into a laboratory workflow. The following functions are available from the touchscreen and can be used after installation to customize the instrument settings and configure it for network use.

- Define the date and the time (page 91)
- Define the instrument settings (page 91)
- Define the maintenance reminders (page 93)
- Define the network settings (page 93)
- Define the system shortcuts (page 94)

- Review the instrument statistics (page 95)
- Review the instrument version information (page 95)
- Enable or disable the instrument security (page 95)
- View the instrument log (page 96)

Note: The touchscreen does not provide access to all instrument functions. Features such as instrument calibration and remote notification are available only through the QuantStudio™ Real-Time PCR Software.

Define the date and time

IMPORTANT! If your laboratory is subject to daylight savings time changes, you must manually adjust the time settings during daylight savings to ensure that the internal clocks of your computer and instrument are synchronized.

1. From the Main Menu of the instrument touchscreen, touch **Settings**, then touch **Set Date & Time**.
2. From the Set Date & Time screen:
 - a. Touch the **Time zone** field, then touch the correct time zone from the list.
 - b. Touch the **Date** field, enter the current date, then touch **Done**.
 - c. Touch the **Date Format** drop-down list, then select the format for your region.
 - d. Touch each Time field, enter the appropriate time units, then touch **Done**.
 - e. Touch **12 Hour** or **24 Hour** to select the appropriate time format.
 - f. Touch **Save** to save the settings, then touch **OK** when prompted.
3. Touch  to return to the Main Menu.

Define the instrument settings

1. In the main menu of the instrument touchscreen, tap **Settings**, then tap **Configure the Instrument**.
2. Tap the **Instrument Name** field, enter up to a 25-character name for the system, then tap **Done**. The instrument name is the alphanumeric string used to identify the instrument on the network.

IMPORTANT! To connect the instrument to a network, the name must be unique.

IMPORTANT! The instrument name cannot include spaces or special characters (such as ; : " < > * + = \ | ? ,).

3. Upload the instrument icon:

The instrument icon is the graphic used to represent the instrument in the QuantStudio™ Real-Time PCR Software **Instrument Console**:

- a. Save the replacement graphic to a USB drive, then plug the drive into the USB port below the touchscreen.

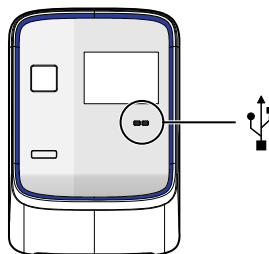

IMPORTANT! Do not use the USB ports on the rear panel of the instrument. The rear USB ports are for use by Thermo Fisher Scientific personnel to service the instrument.

- b. Tap **Upload Icon**, select the desired graphic file, then tap **Done**.

Note: The replacement graphic must be a maximum of 48 × 48 pixels and be stored in the portable net graphic (PNG) format.

4. Define the standby time-out setting:

- a. Select **Standby Time-out** to activate the feature.
- b. Tap the **Standby Time-out** field.
- c. Enter the number of minutes (1–300) that the instrument should remain idle until it enters standby mode, then tap **Done**.

Note: When in standby mode, the instrument powers off the LCD screen backlight and enters low-power mode.

5. Define the heated cover temperature setting:

- a. Select **Cover Idle Temperature** to activate the feature.
- b. Tap the **Cover Idle Temperature** field.
- c. Enter the temperature (50.0–110.0°C) that the heated cover should maintain when the instrument is idle, then tap **Done**.

Note: The recommended cover idle temperature is 60.0°C for reaction plate formats and 85.0°C for the array card format.

6. Tap **Save** to save the settings, tap touch **OK** when prompted.

7. Unplug the USB drive.
8. Tap  to return to the main menu.

Define the maintenance reminders

You can use the QuantStudio™ 6 or 7 Flex System touchscreen screen to:

- Set the expiration period for instrument calibrations and lamp replacement.
- Activate, deactivate, or change the frequency of the maintenance reminders displayed by the QuantStudio™ 6 or 7 Flex System.

To set the reminder:

1. From the Main Menu of the instrument touchscreen, touch **Settings**, then touch **Set Maintenance Reminders**.
2. For each reminder:
 - a. Touch the **Calibration expires after** field.
 - b. Use the keypad to enter the number of days (or, for the lamp, the number of hours) that should elapse before expiration, then touch **Done**.
 - c. (Optional) Touch the checkbox to activate or deactivate an expiration reminder, then go to step 3.
3. (Optional) Configure the reminder:
 - a. Touch the **Display reminders before** field.
 - b. Enter the number of days (or, for the lamp, the number of hours from 1-2000) before which the instrument should display warnings of the impending expiration, then touch **Done**.
4. Touch **Save** to save the settings, then touch **OK** when prompted.
5. Touch  to return to the Main Menu.

Define the network settings

1. In the main menu of the instrument touchscreen, tap **Settings**, then tap **Set Network Information**.

Note: The **Set Network Information** screen displays the Media Access Control (MAC) address of the QuantStudio™ 6 or 7 Flex Real-Time PCR System below the **Autodiscovery** and **Smart Monitoring** check boxes. The MAC address can be used to uniquely identify the system on the network.



2. Tap **Autodiscovery** to make the system discoverable by computers that are running the QuantStudio™ Real-Time PCR Software.

3. Tap **Smart Monitoring** to enable the feature on the QuantStudio™ 6 or 7 Flex Real-Time PCR System.

The Smart Monitoring feature allows Thermo Fisher Scientific service personnel to monitor the status of the QuantStudio™ Real-Time PCR Software remotely through an internet connection. Smart Monitoring employs multiple layers of security, including a Secure Sockets Layer (SSL) and Lightweight Directory Access Protocol (LDAP) authentication, to provide real-time troubleshooting and problem resolution for the system. For a detailed description of the Smart Monitoring Service, see the *Smart Monitoring Service Product Bulletin: Leveraging the power of the Internet while maintaining system security* (Pub. No. 121PB07-03).





4. Set the Internet Protocol (TCP/IP) Properties for either DHCP or Static IP communication.

Network service	Action
DHCP	Tap Obtain an IP address automatically .
Static IP	<ol style="list-style-type: none"> 1. Tap Use the following IP address. 2. Tap the IP Address field, enter the IP address using the keypad, then tap Done. 3. Assign the: <ul style="list-style-type: none"> • IP addresses for the DNS Servers (primary and secondary) • Subnet Mask setting • Default Gateway setting

5. Tap  **Save** to save the settings, then tap **OK** when prompted.
6. Tap  to return to the main menu.

Define the system shortcuts

You can use the QuantStudio™ 6 or 7 Flex System touchscreen to map the shortcut buttons that appear in the Main Menu. You can configure shortcuts to automatically open specific files and folders so that you can access data quickly and easily without having to navigate to it.

1. If the instrument is in standby, touch the QuantStudio™ 6 or 7 Flex System touchscreen to activate it, then press .
2. In the Main Menu, configure the shortcuts as desired: To *add* a shortcut:
 - a. Touch the shortcut of interest, then touch  **Set Shortcut**.
 - b. Touch  **From Templates** to link to a specific template file or touch  **From Folders** to link to a folder.
 - c. Touch the desired template file or folder to configure the shortcut.

To *delete* a shortcut, touch the shortcut of interest, then touch  **Remove Shortcut**, or touch **Remove All** to delete all shortcuts.

3. When you are finished configuring the shortcuts, touch  to return to the Main Menu.

Review the instrument statistics

You can use the QuantStudio™ 6 or 7 Flex System touchscreen to view usage statistics on the heated cover, lamp, and other instrument components.

1. From the Main Menu of the instrument touchscreen, touch **Tools**, then touch **Show Statistics**.
2. When you are finished, touch  to return to the Main Menu.

Review the instrument version information

You can use the QuantStudio™ 6 or 7 Flex System touchscreen to view instrument version data, such as instrument serial number and version numbers for most instrument components and firmware.

1. From the Main Menu of the instrument touchscreen, touch **Tools**, then touch **About the Instrument**.
2. When you are finished, touch  to return to the Main Menu.

Enable or disable instrument security

The QuantStudio™ 6 and 7 Flex Systems feature a secure mode that can be enabled to restrict local instrument functionality. When security is enabled, use of the touchscreen is restricted to administrative functions that change the instrument settings. After the system is secured, you must enter an administrator password to modify the instrument settings, use the firmware tools, or deactivate the secure mode.



IMPORTANT! If you enable or disable the QuantStudio™ 6 and 7 Flex Systems security, auditing, and electronic signature feature, you must similarly enable or disable the QuantStudio™ Real-Time PCR Software security (see “Access the Security screen and enable or disable security” on page 133). The QuantStudio™ Real-Time PCR Software cannot connect to the QuantStudio™ 6 and 7 Flex Systems that do not match security settings.

Note: Secure mode limits the number of features that are available from the system touchscreen. It does not provide user authentication functionality through the instrument touchscreen.

1. If the instrument is in standby, tap the touchscreen to activate it, then tap .
2. In the main menu, tap **Settings**, then tap **Set Administrator Options**.
3. In the **Set Administrator Options** screen, tap **Secure Environment** to enable (checked) or disable (unchecked) system security.
4. (Optional) To change the administrator password:
 - a. Tap **Change Password**.
 - b. Enter the current password, then tap **Done**.
 - c. Enter the new password, then tap **Done**.

- d. Reenter the password when prompted.
- e. Tap **OK** when prompted.

Note: The default password for the instrument touchscreen is *password*; however, the password can be changed during installation.

5. Tap  **Save**.
6. Tap the **Administrator Password** field, enter the administrator password, then tap **Done**.
7. Tap  to return to the main menu.

View the instrument log

You can use the QuantStudio™ 6 or 7 Flex System touchscreen to view a log that summarizes instrument activity from the last 6 months. For each recorded activity, the activity log provides a description of the activity and the date/time when it occurred.

1. From the Main Menu of the instrument touchscreen, touch **Tools**, then touch **View Log**.
2. From the View Log screen, configure the settings to display the records of interest:
 - Select an option from the drop-down menu to filter the log.
 - Select **Earliest First** or **Latest First** to determine the order to sort the records.
3. (Optional) Plug the USB drive into the port below the touchscreen, then touch **Export to USB** to save the log to the drive.

IMPORTANT! Do not use the USB ports on the rear panel of the QuantStudio™ 6 and 7 Flex Systems. The rear USB ports are for use by Thermo Fisher Scientific personnel to service the instrument.

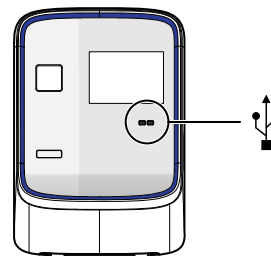

4. Touch  to return to the Main Menu.



Maintenance

■ Decontaminate the sample block	97
■ Replace the halogen lamp	100
■ Replace the instrument fuses	104
■ Install the QuantStudio™ Real-Time PCR Software	105
■ Software licenses	105
■ Update the QuantStudio™ Real-Time PCR Software	106
■ Update the Microsoft™ Windows™ operating system	107
■ Change the sample block	107
■ Change the heated cover	110
■ Change the plate adapter	112

IMPORTANT! This chapter contains all user service procedures for the QuantStudio™ 6 and 7 Flex Systems. Procedures other than those described in this document must be performed by a qualified Thermo Fisher Scientific Service Engineer.

Decontaminate the sample block

Perform this procedure to eliminate fluorescent contaminants from the sample block. Contamination is generally evident in failed background calibrations where one or more wells consistently exhibit abnormally high signals.



CAUTION! PHYSICAL INJURY HAZARD. Do not remove the QuantStudio™ 6 or 7 Flex Real-Time PCR System cover. There are no components inside the instrument that you can safely service yourself. If you suspect a problem, contact a Thermo Fisher Scientific Service Representative.



CAUTION! PHYSICAL INJURY HAZARD. During instrument operation, the sample block can reach 100°C. Allow the sample block to cool to room temperature before performing the procedure.



CAUTION! Before using a cleaning or decontamination method other than those recommended by Thermo Fisher Scientific, confirm with Thermo Fisher Scientific that the proposed method will not damage the equipment.

Materials required

- Bleach, 10% solution
- Tissue, lint-free
- Cotton or nylon swabs and lint-free cloths
- Ethanol, 95% solution
- Safety glasses
- Pipette (100- μ L) with pipette tips
- Powder-free gloves
- Screwdriver
- Deionized water

How to handle the sample block

To prevent damaging or contaminating the sample block, handle the assembly as shown. After the assembly has been removed from the QuantStudio™ 6 or 7 Flex System, place the sample block on a clean, dry surface or in its shipping container.



Clean the sample block



WARNING! PHYSICAL INJURY HAZARD. During instrument operation, the sample block can reach 100°C. Allow the sample block to cool to room temperature before performing the procedure.

IMPORTANT! Wear powder-free gloves when you perform this procedure.

1. Identify the contaminated wells of the sample block (see “How to identify contamination” on page 80).
2. Power off and unplug the QuantStudio™ 6 or 7 Flex Real-Time PCR System, then allow it to cool for 15 minutes.
3. Open the access door.

4. Firmly press down on the handle of the sample block, then remove it from the system. Place the sample block on a clean, dry surface.
5. Clean the contaminated wells of the sample block using deionized water:
 - a. Pipet a small volume of deionized water into each contaminated well.
 - b. In each well, pipet the water up and down several times to rinse the well.
 - c. Pipet the water to a waste beaker.
 - d. Use a cotton swab to scrub inside of each contaminated well.
 - e. Use a lint-free cloth to absorb the excess deionized water.

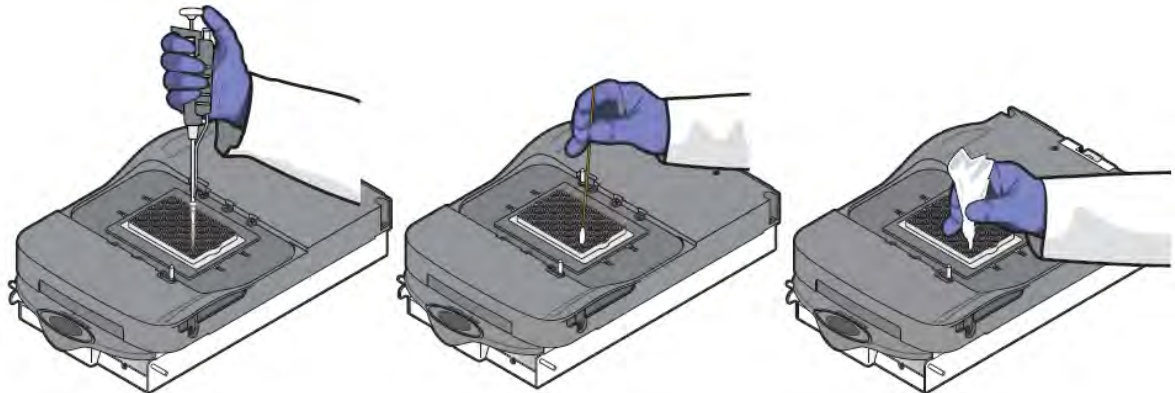
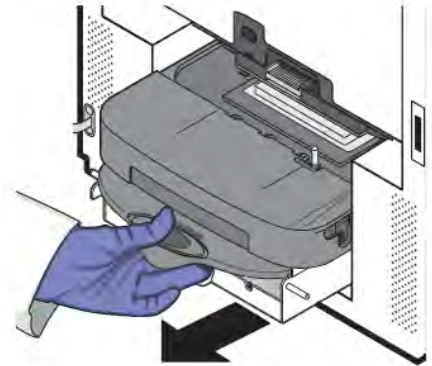

6. Load the sample block into the system, then close the access door.

IMPORTANT! After installing the sample block, confirm that the indicator on the left side of the sample block is positioned behind the red line on the instrument rail. If the indicator is forward of the red line, push the sample block into the system until it is seated correctly.

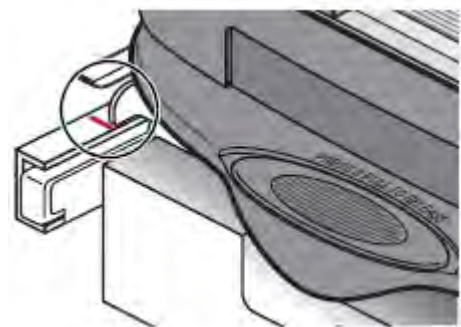

7. Close the access door.

IMPORTANT! Confirm that the access door is completely closed. The QuantStudio™ Real-Time PCR Software displays an error message if the door is not completely closed and latched, or if the sample block is not seated correctly.

8. Plug in, then power on the QuantStudio™ 6 or 7 Flex Real-Time PCR System.
9. Perform a background calibration to confirm that you have eliminated the contamination.

10. If the contamination remains, repeat steps 2–5, then clean the contaminated wells of the sample block using a 95% ethanol solution:
 - a. Pipet a small volume of 95% ethanol solution into each contaminated well.
 - b. In each contaminated well, pipet the solution up and down several times to rinse the well.
 - c. Pipet the ethanol solution to a waste beaker.
11. Repeat steps 5–9 to rinse the wells of the sample block and to ensure that you have eliminated the contamination.

IMPORTANT! Always use deionized water to rinse wells after cleaning with bleach or ethanol solution.

12. If the contamination remains, repeat steps 2–5, then clean the contaminated wells of the sample block using 10% bleach solution:
 - a. Pipet a small volume of 10% bleach solution into each contaminated well.
 - b. In each contaminated well, pipet the solution up and down several times to rinse the well.
 - c. Pipet the bleach solution to a waste beaker.
13. Repeat steps 5–9 to rinse the wells of the sample block and to confirm that you have eliminated the contamination.

IMPORTANT! Always use deionized water to rinse wells after cleaning with bleach or ethanol solution.

14. If the contamination remains, contact Thermo Fisher Scientific.

Replace the halogen lamp

Replace the halogen lamp at or before 2000 hours of life.



WARNING! PHYSICAL INJURY HAZARD. The QuantStudio™ 6 or 7 Flex System and lamp are hot! The lamp can become very hot while in use. Before handling the lamp, allow it to cool for 15 minutes and put on protective, powder-free gloves.



CAUTION! PHYSICAL INJURY HAZARD. Wear disposable, powder-free gloves when handling the lamp to prevent burns and to prevent shortening the life of the replacement lamp.



WARNING! This QuantStudio™ 6 or 7 Flex System is designed for 12 V, 75 W halogen lamps only. Replace with halogen bulbs supplied by Thermo Fisher Scientific.

Materials required

- Safety glasses
- Powder-free gloves
- Halogen bulb (12 V, 75 W)

Halogen lamp warnings

The QuantStudio™ Real-Time PCR Software can display the following warnings before or during an experiment:

- The lamp current is below the acceptable level at the start of the run.
Replace the halogen bulb (see “Replace the lamp” on page 101).
- The QuantStudio™ Real-Time PCR Software stopped the run because the lamp current decreased below the acceptable level during the run.
Replace the halogen bulb (see “Replace the lamp” on page 101). Click **OK** in the message box, then replace the lamp bulb.
- The lamp usage exceeds 2000 hours at the start of a run.
Click **Cancel Run**, then replace the lamp before you perform another experiment.

View the lamp status

1. In the QuantStudio™ Real-Time PCR Software **Home** tab, click **Instrument Console**.
2. From the **Instrument Console**, select your system from the list of instruments, then review the **Lamp Life** and **Last Serviced** readings in the **Maintenance Info** pane.
If the lamp usage has reached 2000 hours, replace the lamp (see “Replace the lamp” on page 101).

Note: The **Lamp Life** report displays the total number of hours that the halogen lamp has been illuminated. The **Last Serviced** report displays the date that the lamp was installed.

Replace the lamp

IMPORTANT! Always wear powder-free gloves when you handle the lamp. Finger prints shorten the lamp life.

1. Record the lamp installation:
 - a. In the main menu of the touchscreen, tap **Tools**, then tap **Record Lamp Installation**.
 - b. Tap the **Name** field, enter any relevant information (such as the make, model, or serial number of the lamp), then tap **Done**.
 - c. Tap the **Comments** field, enter any additional information that you want to record, then touch **Done**.
 - d. Tap **Save**, then tap **OK**.

- e. When asked to confirm lamp replacement, tap **OK**

Note: The data that you enter for the new lamp appear in the instrument log.

2. Power off and unplug the QuantStudio™ 6 or 7 Flex Real-Time PCR System, then allow it to cool for 15 minutes.
3. Open the access door.
4. Remove the lamp from the system:
 - a. Slide the lamp release lever downward.
 - b. Firmly grasp the lamp and lift it up and out of the slotted mount.

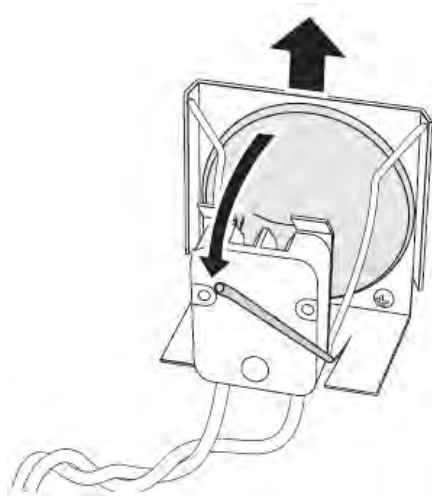

5. Inspect the lamp for damage (carbon usually coats the inside of a failed lamp). If necessary, dispose of the lamp and obtain a replacement.

IMPORTANT! Dispose of the lamp in accordance with your local municipal waste ordinances. Do not dispose of the lamp as unsorted municipal waste.

6. Install the new lamp into the QuantStudio™ 6 or 7 Flex Real-Time PCR System:
 - a. Slide the lamp release lever upward.

- b. Firmly grasp the lamp, place it into the slotted mount, then carefully slide the lamp downward into place.

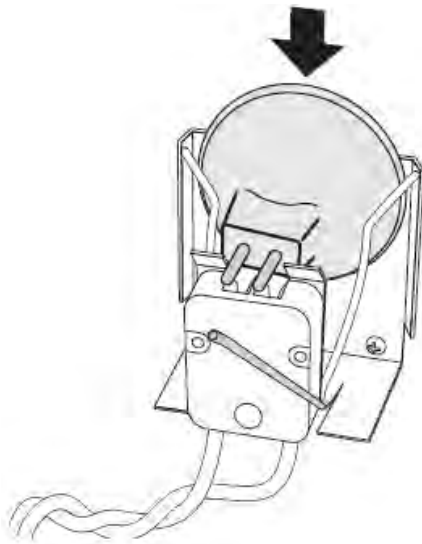

7. Close the access door.
8. Plug in and power on the QuantStudio™ 6 or 7 Flex Real-Time PCR System.

IMPORTANT! Confirm that the access door is completely closed. The QuantStudio™ Real-Time PCR Software displays an error message if the door is not completely closed and latched, or if the lamp is not seated correctly.

9. Start the QuantStudio™ Real-Time PCR Software, then perform an ROI calibration.
While the system is running, look through grating of the access door and confirm that the lamp is illuminated.
 - If the lamp is illuminated, the lamp has been installed successfully.
 - If the lamp is not illuminated, the replacement halogen lamp may be defective. Replace the lamp again. If the second lamp does not illuminate, check the system fuses for failure (see “Replace the instrument fuses” on page 104).
10. After replacing the lamp, perform the following calibrations in the specified order:
 - a. ROI calibration
 - b. Background calibration
 - c. Uniformity calibration
 - d. Dye calibration
 - e. Normalization calibration
 - f. RNase P test

Replace the instrument fuses

Replace the QuantStudio™ 6 or 7 Flex System fuses when the fuses fail.



CAUTION! FIRE HAZARD. For continued protection against the risk of fire, replace fuses only with listed and certified fuses of the same type and rating as those currently in the QuantStudio™ 6 or 7 Flex System.

Materials required

- Fuses, 12.5A, Time-Lag T, 250VAC, 5 × 20-mm (2)
- Fuses for AU/NZ only, 6.3A, Time-Lag T, 250VAC, 5 × 20-mm (2)
- Safety glasses
- Powder-free gloves
- Screwdriver, flathead

Replace the fuses

1. Power off, then unplug the QuantStudio™ 6 or 7 Flex System. Allow it to cool for 15 minutes.
2. Using a flat-head screwdriver, unscrew and remove the fuse holder.

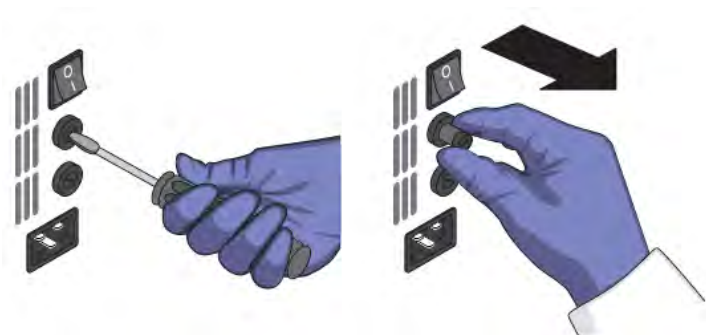

3. Remove each fuse from its fuse holder and inspect it for damage. Carbon typically coats the inside of failed fuses.
4. Replace each failed fuse with a 12.5A, Time-Lag T, 250VAC, 5 × 20-mm Fuse.

Note: The voltage and amperage ratings are on the fuse holder.

Note: For AU/NZ only, replace each failed fuse with a 6.3A, Time-Lag T, 250VAC, 5 × 20-mm Fuse.



5. Install the fuse holder.
6. Plug in, then power on the QuantStudio™ 6 or 7 Flex System. The installation is successful if the instrument powers on.

Note: Fuse failure can result from fluctuations in the supplied power to the QuantStudio™ 6 or 7 Flex System. To prevent further failures, consider installing an electrical protective device, such as a UPS or a surge protector.

Install the QuantStudio™ Real-Time PCR Software

Computer requirements

See “Computer requirements” on page 21 for a list of hardware and operating system requirements for the QuantStudio™ 6 and 7 Flex Real-Time PCR System Software.

Install the software

1. Go to thermofisher.com/qpcrsoftware.
2. In the **Real-Time PCR** section, click **Applied Biosystems QuantStudio 6 & 7 Flex Real-Time PCR Systems**.
3. Click **Download**, then follow the instructions.

Software licenses

The base QuantStudio™ Real-Time PCR Software does not require a license.

The High Resolution Melting (HRM) Software and the SAE module require licenses.

Activate a license

A valid license key is required for the High Resolution Melting (HRM) Software or the SAE module.

IMPORTANT! An internet connection, a web browser, and a valid email account are required to activate a license for the modules. If the computer that contains the QuantStudio™ Real-Time PCR Software is not connected to the internet or it lacks a web browser application, contact Technical Support to request the license file.

1. In the QuantStudio™ Real-Time PCR Software **Home** tab, select **Tools ▶ License Central**.
2. In the **License Central** dialog box, select the license of interest from the table, click **Activate License**, then wait for the default web browser application to connect to thermofisher.com.
3. From the **Software License Activation** page, select the module, then activate the license as instructed.

After you successfully activate the license, you will receive an email containing the activated license file (LIC) to install on your computer.

Install a license file

Activate a license and receive a license file (LIC) (see “Activate a license” on page 105).

The following steps describe how to install the license file to in order to unlock the High Resolution Melting (HRM) Software or the SAE module.

Note: Each license file is generated specifically for the computer that was used to activate the license key.

1. Save the license file (LIC) to the computer that contains the QuantStudio™ Real-Time PCR Software.
2. In the QuantStudio™ Real-Time PCR Software **Home** tab, select **Tools ▶ License Central**.
3. From the **License Central** dialog box, click **Install License**.
4. From the **Open** dialog box, navigate to the license file, then click **Open**.
5. Click **OK** to close the **License Central** dialog box.

Note: Contact Technical Support if the software fails to install the license.

Update the QuantStudio™ Real-Time PCR Software

Thermo Fisher Scientific may release updates to the QuantStudio™ Real-Time PCR Software that you can install without the aid of Thermo Fisher Scientific service personnel. You can obtain updates directly from the service section of [thermofisher.com](https://www.thermofisher.com).

For the latest services and support information for the QuantStudio™ 6 or 7 Flex Real-Time PCR System:

1. Go to [thermofisher.com/qpcrsoftware](https://www.thermofisher.com/qpcrsoftware).
2. On the **Software Downloads** page, select **Applied Biosystems™ QuantStudio™ 6 and 7 Flex Systems** from the menu.
3. On the **Software Downloads** page, click **Updates - Patches**.

The website opens the page describing the latest software updates for the system.

Update the software

Prepare for the upgrade

To prepare for the software update, back up all data files and experiments by creating a copy of the directory that you are using to store files. The default directories are:

- **Installation directory** – <drive>:\Program Files\Applied Biosystems\QuantStudio 6 and 7 Flex Software
- **Data directory** – <drive>:\Applied Biosystems\AppData\QuantStudio 6 and 7 Flex Software
- **User files directory** – <drive>:\Applied Biosystems\QuantStudio 6 and 7 Flex Software\User Files\experiments

Note: <drive> is the location where the software is installed.

Install the software

Install the software update according to the instructions that download with the software. A license is not needed for the base version of the QuantStudio™ Real-Time PCR Software.

Update the Microsoft™ Windows™ operating system

Do not upgrade or update the Microsoft™ Windows™ operating system of the computer running the QuantStudio™ Real-Time PCR Software without first consulting the software release notes or thermofisher.com. Future versions and updates to the Windows™ operating system may conflict with the software.

1. Go to thermofisher.com/qpcrsoftware.
2. In the **Real-Time PCR** section, click **Applied Biosystems QuantStudio 6 & 7 Flex Real-Time PCR Systems**.
3. Click **Read Me**.
4. If the release notes do not contain the information of interest, contact Technical Support.

Change the sample block



WARNING! PHYSICAL INJURY HAZARD. During instrument operation, the sample block and heated cover can reach 100°C. Allow the sample block to cool to room temperature before removing.

When to change the sample block

You can change the sample block:

- To change the consumable format of the QuantStudio™ 6 or 7 Flex System.
- In the event of a hardware failure.

Materials required

- Safety glasses
- Powder-free gloves
- Sample block

How to handle the sample block

To prevent damaging or contaminating the sample block, handle the assembly as shown. After the assembly has been removed from the QuantStudio™ 6 or 7 Flex System, place the sample block on a clean, dry surface or in its shipping container.



Change the sample block

1. Power off and unplug the QuantStudio™ 6 or 7 Flex Real-Time PCR System, then allow it to cool for 15 minutes.
2. Open the access door.
3. Firmly press down on the handle of the sample block, then remove it from the system. Place the sample block on a clean, dry surface.

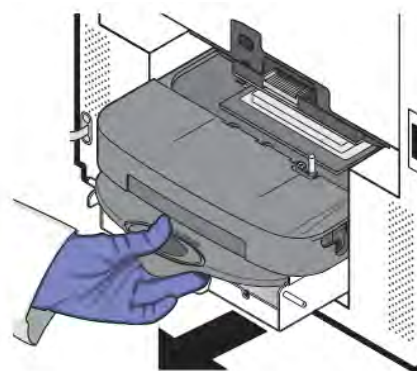

4. Install the new sample block into the QuantStudio™ 6 or 7 Flex Real-Time PCR System.

IMPORTANT! After installing the sample block, confirm that the indicator on the left side of the sample block is positioned behind the red line on the instrument rail. If not, push the sample block into the system until it is seated correctly.

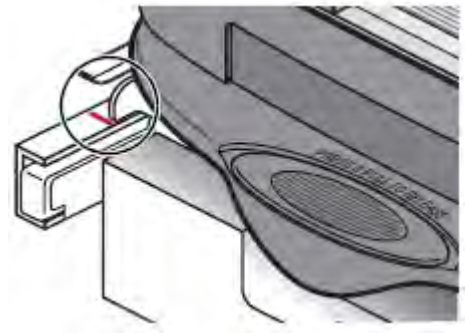

5. If you are installing a sample block of a different consumable format, replace the heated cover and plate adapter if necessary.
6. Close the access door.

IMPORTANT! Confirm that the access door is completely closed. The QuantStudio™ Real-Time PCR Software displays an error message if the door is not completely closed and latched, or if the sample block is not seated correctly.

7. Plug in and power on the QuantStudio™ 6 or 7 Flex Real-Time PCR System.
8. In the QuantStudio™ Real-Time PCR Software **Home** tab, click **Instrument Console**.
9. In the **Instrument Console**, select your instrument from the list of instruments, then review the **Block Type** field in the **Instrument Properties** pane.
The installation is successful if the system powers on and if the **Block Type** field displays the correct type of sample block.

Note: The **Block Type** field displays the type of sample block installed in the system.

10. Check the calibration status of the system (see “View the calibration status of an instrument” on page 27).

If the calibrations for the new sample block/heated cover have expired, perform the following calibrations in the specified order:

- a. ROI calibration
- b. Background calibration
- c. Uniformity calibration
- d. Dye calibration
- e. Normalization calibration

IMPORTANT! If the calibrations for the new sample block/heated cover are valid, you do not need to recalibrate the QuantStudio™ 6 or 7 Flex Real-Time PCR System.

Change the heated cover



WARNING! PHYSICAL INJURY HAZARD. During instrument operation, the sample block and heated cover can reach 100°C. Allow the heated cover to cool to room temperature before removing.

When to change the heated cover

You can change the heated cover:

- To change the consumable format of the QuantStudio™ 6 or 7 Flex System.
- In the event of a hardware failure

Materials required

- Safety glasses
- Powder-free gloves
- Heated cover

How to handle the heated cover

To prevent damaging or contaminating the heated cover, handle the assembly as shown below. After the assembly has been removed from the QuantStudio™ 6 or 7 Flex System, place the heated cover on a clean, dry surface or in its shipping container.



Change the heated cover

Note: Confirm that the replacement heated cover supports the plate or array card format that you want to use. Some heated covers support more than one consumable type.

1. Power off and unplug the QuantStudio™ 6 or 7 Flex Real-Time PCR System, then allow it to cool for 15 minutes.
2. Open the access door.

3. Unlock the heated cover by pinching the handle together, then pull the assembly from the system and place it on a clean, dry surface.

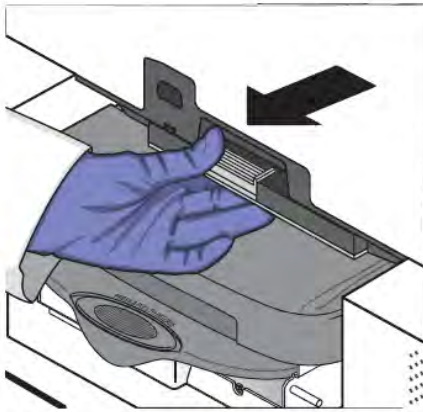

4. Install the new heated cover into the QuantStudio™ 6 or 7 Flex Real-Time PCR System.

IMPORTANT! Align the arrows on the front handle as shown below. If the arrows are not aligned, push the heated cover into the system until the handle locks into place.

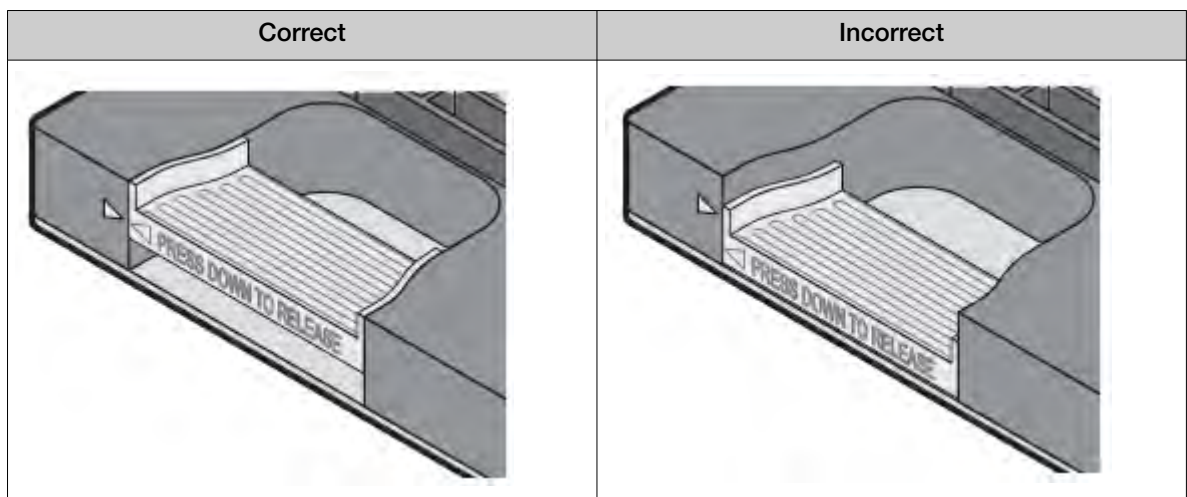

5. If you are installing a heated cover of a different consumable format, replace the sample block and plate adapter if necessary.
6. Close the access door and ensure it is completely closed.

Note: The QuantStudio™ Real-Time PCR Software displays an error message if the door is not completely closed and latched, or if the sample block is not seated correctly.

7. Plug in and power on the QuantStudio™ 6 or 7 Flex Real-Time PCR System.
8. In the QuantStudio™ Real-Time PCR Software **Home** tab, click **Instrument Console**.

9. In the **Instrument Console**, select your instrument from the list of instruments, then review the **Heated Cover Firmware Version** field in the **Instrument Properties** pane.

The installation is successful if the system powers on and if the **Heated Cover Firmware Version** field displays a version number.

10. Check the calibration status of the system (see “View the calibration status of an instrument” on page 27).

If the calibrations for the new sample block/heated cover have expired, perform the following calibrations in the specified order:

- a. ROI calibration
- b. Background calibration
- c. Uniformity calibration
- d. Dye calibration
- e. Normalization calibration

IMPORTANT! If the calibrations for the new sample block/heated cover are valid, you do not need to recalibrate the QuantStudio™ 6 or 7 Flex Real-Time PCR System.

Change the plate adapter

Change the plate adapter in the event of a hardware failure or if you want to change the consumable format of the QuantStudio™ 6 or 7 Flex System.



WARNING! PHYSICAL INJURY HAZARD. During instrument operation, the plate adapter can reach 100°C. Allow the plate adapter to cool to room temperature before removing.

When to change the plate adapter



You can change the plate adapter:

- To change the consumable format of the QuantStudio™ 6 or 7 Flex System.
- In the event of a hardware failure

Materials required

- Safety glasses
- Powder-free gloves
- Plate adapter

Change the plate adapter

1. Touch the instrument touchscreen to activate it, then press .
2. From the Main Menu, touch .
3. When the tray arm opens, pull the latch, then lift and remove the plate adapter.

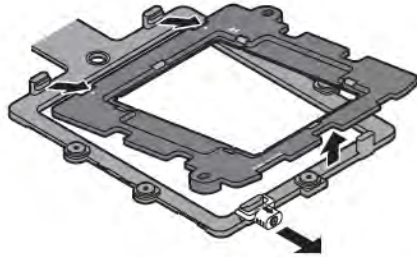

4. Attach the new adapter to the tray arm, then pull the latch to allow the adapter to lower into place. If necessary, apply pressure as indicated until the adapter snaps into place.

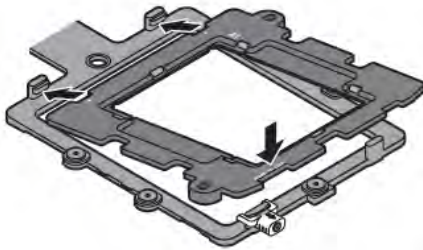

5. From the Main Menu, touch .
6. If you are installing a tray adapter of a different consumable format, replace the sample block and heated cover if necessary.



Networking

■ Networking overview	114
■ Network setup workflow	118
■ Collect the required network information	118
■ Connect the QuantStudio™ 6 or 7 Flex System to the network	118
■ Connect the computer to the network	120
■ Monitor the QuantStudio™ 6 or 7 Flex Real-Time PCR System	121

IMPORTANT! This chapter *does not* provide adequate detail to integrate the QuantStudio™ 6 or 7 Flex Systems into all possible network architectures. Because your network may contain advanced features (such as a firewall or network domains), consult a network administrator before connecting the QuantStudio™ 6 or 7 Flex Systems to your laboratory network.

Networking overview

After installing the QuantStudio™ 6 or 7 Flex System, you can connect the QuantStudio™ 6 or 7 Flex System to a local area network to enhance its functionality.

This appendix describes how to:

- Set up the QuantStudio™ 6 or 7 Flex System for use on a network.
- Set up a computer for remote monitoring.
- Test the network connection by engaging the remote monitoring feature.

Controlling and monitoring networked QuantStudio™ 6 and 7 Flex Systems

When the QuantStudio™ 6 or 7 Flex Real-Time PCR System is connected to a network, computers on the network that are running the QuantStudio™ Real-Time PCR Software can control or monitor it. The software can control up to 4 instruments and monitor up to 10 instruments simultaneously. A networked system can be controlled by only one computer at a time. A networked computer running the QuantStudio™ Real-Time PCR Software can transfer experiments to and from an instrument, begin or stop a run, and perform some maintenance functions. During a run, the Remote Monitoring feature of the software can be used to view the run status, temperature, and amplification data in real-time.

Note: Remote monitoring does not allow you to control the system.



About the ethernet port

The QuantStudio™ 6 or 7 Flex Real-Time PCR System features a Gigabit Ethernet port for direct communication with the system computer and for network communication. When the system is connected to a network, computers on the network that run the QuantStudio™ Real-Time PCR Software can:

- Send and download experiments to and from the QuantStudio™ 6 or 7 Flex Real-Time PCR System.
- Run experiments on the QuantStudio™ 6 or 7 Flex Real-Time PCR System.
- Remotely monitor the QuantStudio™ 6 or 7 Flex Real-Time PCR System as it performs runs.

The Ethernet port of the system supports:

- Static IP network service with subnet mask, primary and secondary data network service (DNS), and default gateway settings, or dynamic host configuration protocol (DHCP) network service
- mDNS/DNS for local domains

Note: Because mDNS is limited to direct network connections, a system set for mDNS may not be visible to other nodes that are separated by a router, hub, or another network device.

- IPv4 link-local (IPv4LL) in the RFC (also known as Automatic Private IP Addressing [APIPA] or Internet Protocol Automatic Configuration [IPAC])

Note: When the QuantStudio™ 6 or 7 Flex Real-Time PCR System is set for DHCP, APIPA is automatically enabled, and the system provides an IP address when no address is supplied by the DHCP server.

Firewall ports that must be open

Table 8 v1.3

Ports	Condition
mDNS, 7000	Instrument-to-computer connection
mDNS, 5353	Instrument discovery

Example network layouts

Example 1

In the following example, one or more of the QuantStudio™ 6 and 7 Flex Systems, which have been configured for dynamic host configuration protocol (DHCP) operation, are connected to a network by their Ethernet ports. In this layout, any computer on the network can monitor and control the systems.

Note: A networked computer running the QuantStudio™ Real-Time PCR Software can simultaneously control up to 4 instruments and monitor up to 10 instruments that have been connected to the network.

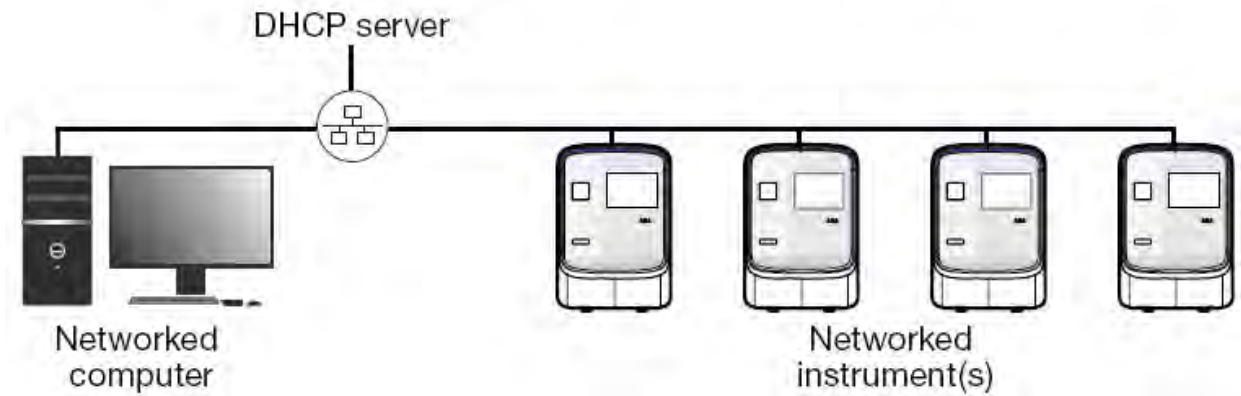

Example 2

In the example shown below, the QuantStudio™ 6 or 7 Flex Real-Time PCR System is connected directly to the computer, which is also connected to the local area network. In this configuration, the computers on the network can exchange experiments with the system computer. The QuantStudio™ 6 or 7 Flex Real-Time PCR System can be neither monitored nor controlled remotely because it is physically isolated from the network.

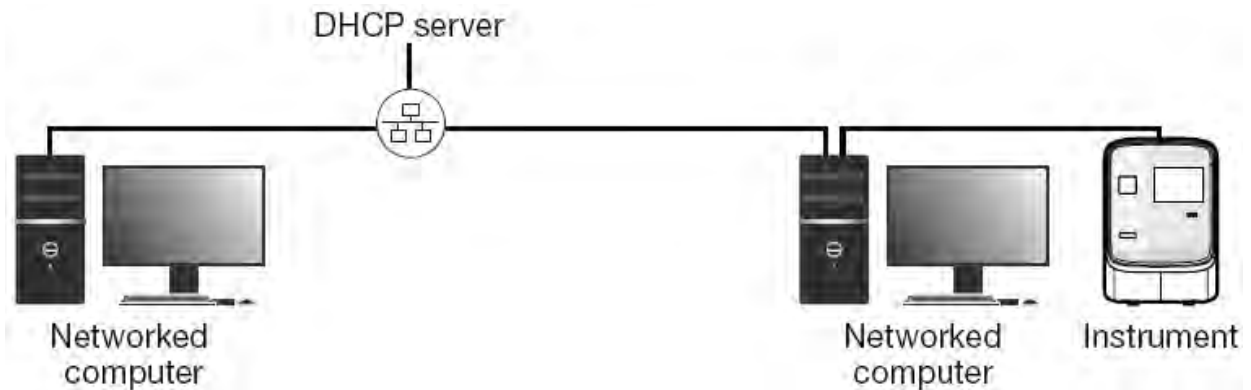



Networking guidelines and best practices

- Consult a network administrator.
 - We recommend that you consult a network administrator before connecting the QuantStudio™ 6 or 7 Flex Real-Time PCR System to your laboratory network.
 - To enable the full functionality of the QuantStudio™ Real-Time PCR Software, the computer requires a network connection.

- Limit remote monitoring to 10 computers.

Avoid using more than 10 computers to simultaneously monitor the system remotely. Although the system supports remote monitoring from multiple computers, each connection taxes the instrument microprocessor. Too many connections can overburden the system and result in instrument errors.

Note: The effects of an overburdened system are evident in the Temperature Plot during a run. Symptoms can include extended hold times or brief, unexpected plateaus in the instrument Temperature Plot.

- Observe the restrictions to mDNS and Autodiscovery.

The QuantStudio™ 6 or 7 Flex Real-Time PCR System supports mDNS but only when the system and the computer share a direct network connection and are within the same subnet. Consequently, network computers that are separated from the system by a router, hub, or another network device may not be able to access the system by its host name.

- Confirm the uniqueness of the instrument name.

The QuantStudio™ 6 or 7 Flex Real-Time PCR System does support name resolution but the instrument name must be unique within the subnet. The QuantStudio™ Real-Time PCR Software can automatically discover systems on the link-local network that are configured for Autodiscovery.

Note: The system does not test the uniqueness of the instrument name when it is set.

- Name systems using lowercase letters.

When you define the system settings, enter the instrument name using lowercase letters only.



Network setup workflow

The following figure illustrates the workflow for installing the QuantStudio™ 6 or 7 Flex System to a local area network.

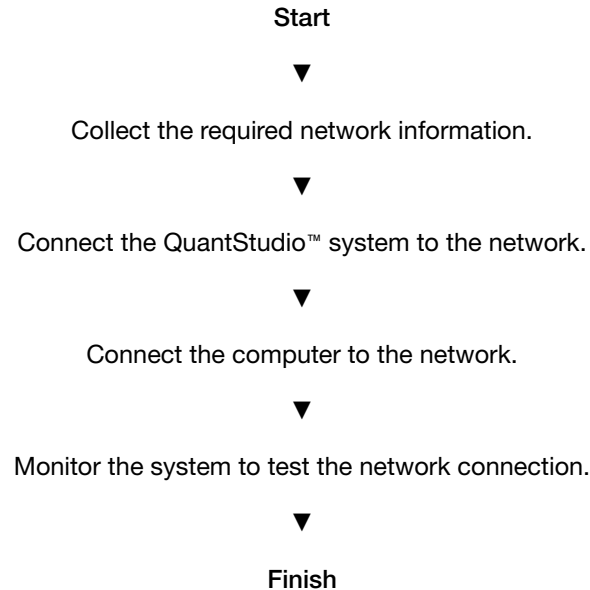

Collect the required network information

Obtain the following information from your network administrator:

- Network policy for obtaining IP addresses (DHCP or static IP).

IMPORTANT! When the QuantStudio™ 6 or 7 Flex System is set for DHCP, APIPA is automatically enabled and the QuantStudio™ 6 or 7 Flex System self assigns an IP address when no address is supplied by a DHCP server.

- If the network requires static IP addresses, obtain the IP address, subnet mask, and gateway address for the QuantStudio™ 6 or 7 Flex System.

Connect the QuantStudio™ 6 or 7 Flex System to the network

After deciding how to connect the QuantStudio™ 6 or 7 Flex System to a network, set up the QuantStudio™ 6 or 7 Flex System according to your network policies.

Materials required

Ethernet cable with RJ45 connectors (a CAT6 Ethernet cable for a 1000Mbit/s network connection or a CAT5 for 100Mbit/s connection)



Define the instrument internet protocol settings

1. Use the Ethernet cable to connect the Ethernet port of the QuantStudio™ 6 or 7 Flex Real-Time PCR System to the nearest network port.
2. Power on the system.
3. In the main menu of the touchscreen, tap **Settings** then tap **Set Network Information**.

Note: The **Set Network Information** screen displays the Media Access Control (MAC) address of the system below the **Autodiscovery** and **Smart Monitoring** check boxes. The MAC address can be used to uniquely identify the system on the network.

4. Tap **Autodiscovery** to make the system discoverable by computers that are running the QuantStudio™ Real-Time PCR Software.
5. Tap **Smart Monitoring** to enable the feature on the QuantStudio™ 6 or 7 Flex Real-Time PCR System.

The Smart Monitoring feature allows Thermo Fisher Scientific service personnel to monitor the status of the system remotely through an internet connection. Smart Monitoring employs multiple layers of security, including a Secure Sockets Layer (SSL) and Lightweight Directory Access Protocol (LDAP) authentication, to provide real-time troubleshooting and problem resolution for the instrument. For a detailed description of the Smart Monitoring Service, see the *Smart Monitoring Service Product Bulletin: Leveraging the power of the Internet while maintaining system security* (Pub. No. 121PB07-03).

6. Set the Internet Protocol (TCP/IP) Properties for either DHCP or Static IP communication.

Network service	Action
DHCP	Tap Obtain an IP address automatically .
Static IP	<ol style="list-style-type: none"> 1. Tap Use the following IP address. 2. Tap the IP Address field, enter the IP address using the keypad, then tap Done. 3. Assign the: <ul style="list-style-type: none"> • IP addresses for the DNS Servers (primary and secondary) • Subnet Mask setting • Default Gateway setting

7. Tap **Save** to save the settings, then tap **OK** when prompted.
8. Tap  to return to the main menu.



Connect the computer to the network

Materials required

Ethernet cable with RJ45 connectors

Computer requirement

If you are connecting a computer that you provided to a network, confirm that the computer contains a free network port.

Collect required information

Obtain the following information from your network administrator:

- Network policy for obtaining IP addresses (DHCP or static IP)
- If the network requires static IP addresses, obtain the IP address, subnet mask, and gateway address for the computer

Set up the computer

IMPORTANT! We recommend that you arrange for a network administrator to connect your computer to the network. The following procedure does not provide adequate detail for all network architectures.

Note: The following procedure is valid for the Microsoft™ Windows™ 7 operating system.

1. Use the Ethernet cable to connect the computer to the nearest network port.
2. Power on the computer, then log in using a user account that belongs to the Administrators user group.
3. From the desktop, right-click **My Network Places**, then select **Properties**.
4. Right-click **Local Area Connection**, then select **Properties**.
5. Select **Internet Protocol (TCP/IP)**, then click **Properties**.



6. Set the Internet Protocol (TCP/IP) Properties for either DHCP or Static IP communication:

Network configuration	Action
DHCP	<ol style="list-style-type: none"> 1. Select Obtain an IP address automatically. 2. Set the DNS address. If the computer obtains DNS addresses: <ul style="list-style-type: none"> • Automatically – Select Obtain DNS server address automatically. • Statically – Select Use the following DNS address, enter the address of the preferred and alternate DNS servers if available.
Static IP	<ol style="list-style-type: none"> 1. Select Use the following IP address. 2. In the IP Address field, enter the static IP address. 3. If necessary, enter a subnet mask. 4. If necessary, enter a static gateway address in the Default Gateway field.

7. If your network requires advanced TCP/IP setup (such as WINS), define the settings:

- a. Click **Advanced** in the Internet Protocol (TCP/IP) Properties dialog box.
- b. Define the IP Settings, DNS, and WINS tabs as instructed by your systems administrator, then click **OK**.

8. Close all dialog boxes by clicking **OK**.

9. Restart the computer.

The computer is now visible to other computers on the network.

Install the QuantStudio™ Real-Time PCR Software

See “Install the software” on page 107.

Note: You must install the QuantStudio™ Real-Time PCR Software in order to monitor the QuantStudio™ 6 or 7 Flex Real-Time PCR System over the network.

Monitor the QuantStudio™ 6 or 7 Flex Real-Time PCR System

After connecting the system and a computer to the network, you can enable remote monitoring in the QuantStudio™ Real-Time PCR Software to observe the instrument status remotely.



About remote monitoring

When the QuantStudio™ 6 or 7 Flex Real-Time PCR System is connected to the network, any computer on the network that is running the QuantStudio™ Real-Time PCR Software can:

- Monitor the status of a run (see page 122)
- Download experiment files (see page 122)
- Enable or change the calibration reminders (see page 123)

Guidelines for remote monitoring

To ensure optimal performance of the remote monitoring feature, observe the following guidelines:

- The QuantStudio™ Real-Time PCR Software can monitor up to 10 instruments.
- We do not recommend that a QuantStudio™ 6 or 7 Flex Real-Time PCR System be monitored by more than 10 computers simultaneously.
- Unless you are sure that your system and computer exist on the same subnet, we recommend that you use the IP address of the QuantStudio™ 6 or 7 Flex Real-Time PCR System to add it for remote monitoring.

Monitor the status of a run from the QuantStudio™ Real-Time PCR Software

1. In the QuantStudio™ Real-Time PCR Software **Home** tab, click **Instrument Console**.
2. In the **Instrument Console**, select the icon for your instrument, then click **Manage Instrument**.

Note: If the **Manage Instrument** button is inactive, add your instrument to the My Instruments group.

3. In the **Instrument Manager**, click **Monitor**, then click **Information**.
4. In the **Monitor Instrument** screen, click **Monitor Running Instrument**.

The QuantStudio™ Real-Time PCR Software displays the status, attributes, calibration status, and plot data for the selected system. If a communications warning appears, contact your network administrator to troubleshoot the problem.

You can lose the software connection to the system if you:

- Change the system that is connected directly to your computer
- Use the touchscreen to change the instrument name or IP address

Note: To reestablish the connection, restart the software.

Download experiment files

For more information about using the QuantStudio™ Real-Time PCR Software to transfer experiment results from the QuantStudio™ 6 or 7 Flex Real-Time PCR System, see “Transfer experiments, templates, and results data” on page 85.



Enable or change the calibration reminders

The calibration reminder settings allow you to configure the QuantStudio™ Real-Time PCR Software to alert you by email when the QuantStudio™ 6 or 7 Flex Real-Time PCR System requires calibration. The notifications settings feature is optional, and it does not affect performance.

IMPORTANT! The QuantStudio™ Real-Time PCR Software transmits email only while the system is monitored. If the network connection is interrupted, the software stops transmitting updates.

Collect the required information

The QuantStudio™ Real-Time PCR Software requires access to a Simple Mail Transfer Protocol (SMTP) server to email calibration reminders. Contact your systems administrator or information technology department for the following information:

- Network address of a SMTP server.
- A user name and password for the server, if required for access.
- The Secure Sockets Layer (SSL) setting of the server (on or off).

Define the mail server settings

1. In the QuantStudio™ Real-Time PCR Software, select **Tools ▶ Preferences**.
 2. In the **Preferences** dialog box, select the **SMTP Settings** tab.
 3. In the **SMTP Settings** tab, define the settings for the SMTP server:
 - **Outgoing Mail Server (SMTP)** field—Enter the network address of a Simple Mail Transfer Protocol (SMTP) server. Optionally, you can specify the transmission control protocol (TCP) port for the server by appending the port number to the server name, separating the two using a colon (:).
For example: *smtp.mycompany.com:2023*
-
- Note:** If a TCP port is not specified, the QuantStudio™ Real-Time PCR Software uses the default port number (25).
-
- **Encryption Required**—Select if the mail server has SSL enabled.
 - **Authentication Required**—Select if the mail server requires a user name and password.
 - **User Name** and **Password** fields—If the mail server requires authentication, enter the user name provided by your systems administrator.
4. Click **OK**.

Modify the notification settings for a monitored QuantStudio™ 6 or 7 Flex Real-Time PCR System

1. Open the **Calibration Reminders** screen for the QuantStudio™ 6 or 7 Flex Real-Time PCR System:
 - a. In the QuantStudio™ Real-Time PCR Software **Home** tab, click **Instrument Console**.



- b. In the **Instrument Console**, select your instrument from the list of instruments on the network, then click **Add to My Instruments**.

Note: You must add a system to your list before you can manage it.

- c. After the system is added to your list, select it, then click **Manage Instrument**.
 - d. In the **Instrument Manager**, click  **Maintenance**, then click **Calibration Reminders**.
2. In the **Calibration Reminders Setting** table, configure the notification settings for the calibrations in interest. For each calibration that you want to monitor:
 - a. In the **Expiry Interval** column, enter the number of days that elapse before the type of calibration expires on the system.
 - b. In the **Send a Reminder** column, select the check box to configure the QuantStudio™ Real-Time PCR Software to email a reminder to perform the calibration.
 - c. In the **Reminder Interval** column, enter the number of days that elapse before the software emails recipients a reminder to perform the calibration.
 3. In the **Enter e-mail addresses for notifications** field, enter the email address(es) that you want to receive email notifications. Separate multiple email addresses with commas (,).
 4. Click **Apply** to change the notification settings.



Power on or off, store, and move

- Place the QuantStudio™ 6 or 7 Flex Real-Time PCR System on standby 125
- Power on the QuantStudio™ 6 or 7 Flex Real-Time PCR System 125
- Power off the QuantStudio™ 6 or 7 Flex Real-Time PCR System 126
- Store the QuantStudio™ 6 or 7 Flex System 127
- Move the QuantStudio™ 6 or 7 Flex System 128

Place the QuantStudio™ 6 or 7 Flex Real-Time PCR System on standby

If left unattended, the system automatically enters standby mode to conserve power. To enter standby mode manually, tap  on the system touchscreen.

Power on the QuantStudio™ 6 or 7 Flex Real-Time PCR System

To power on the QuantStudio™ 6 or 7 Flex System from a powered-off state:

1. Tap anywhere on the touchscreen to determine if the QuantStudio™ 6 or 7 Flex Real-Time PCR System is in standby mode.
Does the touchscreen display the **Standby** screen after you touch it?
 - **Yes**—The instrument is ready for use. Go to step 4.
 - **No**—Go to step 2 to power on the instrument.
2. Power on the system. Toggle the power button on the rear of the system, then wait for it to start.

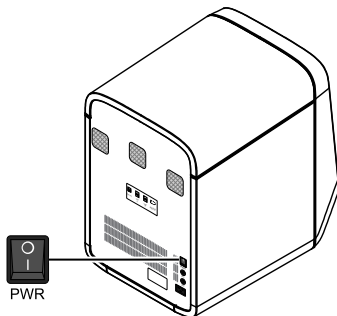

The system is ready to use when the touchscreen displays the main menu.

3. Power on the monitor.
4. Power on the computer:
 - a. Press the computer power button, then wait for it to start.
 - b. When the **Login** screen appears, enter your user name and password, then click **OK**.
5. Start the QuantStudio™ Real-Time PCR Software:
 - a. On the desktop, double-click **QuantStudio™ Real-Time PCR Software**.

Note: If the shortcut is not present on the desktop, select **Start ▶ All Programs ▶ Applied Biosystems ▶ QuantStudio Real-Time PCR Software** to start the software.

IMPORTANT! If the software does not start, confirm that no other instances of the instrument control software are open. If any instance of the software is open, close it before starting the software.

- b. If the QuantStudio™ Real-Time PCR Software **Login** appears, enter your user name and password, then click **Log In**.



Note: Security is a separately licensed module. If your system requires this module, contact Thermo Fisher Scientific.

Note: If the software displays the **License Central** screen after you log into the software, your license file may have become corrupt. Contact Support to obtain a replacement license file.

Power off the QuantStudio™ 6 or 7 Flex Real-Time PCR System

The systems operate in low-power mode when not in use. The system can be powered off completely so that the components draw no power.

Note: If the systems are inactive for extended periods of time, prepare them for storage (see “Store the QuantStudio™ 6 or 7 Flex System” on page 127).

1. Power off the QuantStudio™ 6 or 7 Flex Real-Time PCR System:
 - a. If the touchscreen is not blank, tap  to place the system into stand-by mode.

- b. Toggle the power button on the rear of the QuantStudio™ 6 or 7 Flex Real-Time PCR System.

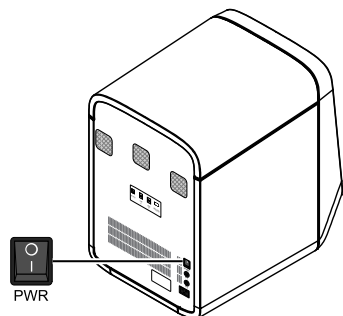

2. Power off the computer:
 - a. From the desktop, select **Start ▶ Shut Down**.
 - b. From the Shut Down Windows™ dialog box, select **Shut Down**, then click **OK**.
3. Power off the monitor.

Store the QuantStudio™ 6 or 7 Flex System

The QuantStudio™ 6 or 7 Flex System can be powered off and stored for extended periods of time. The length of the period of inactivity determines the method you use to power off the QuantStudio™ 6 or 7 Flex System.





Materials required

Reaction plate or array card (unused)

Prepare the QuantStudio™ 6 or 7 Flex Real-Time PCR System

1. If you plan to store the QuantStudio™ 6 or 7 Flex Real-Time PCR System for more than a week or you plan to move it, load an unused plate or array card into the system:

Note: The empty plate or array card protects the internal components of the system during transport or during periods of inactivity lasting more than a week.

- a. Tap  on the touchscreen.
- b. Tap  to eject the tray arm, place a plate or array card onto the plate adapter, then tap  again to load the plate.
- c. Tap  to place the system in stand-by mode.

2. Toggle the power button on the rear of the system.

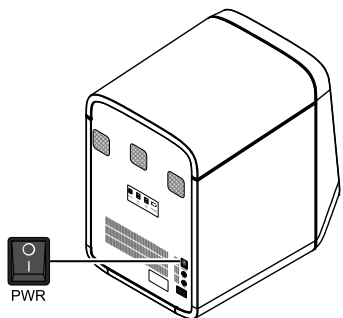

3. Power off the computer:
 - a. Select **Start ▶ Shut Down**.
 - b. From the Shut Down Windows™ dialog box, select **Shut Down**, then click **OK**.
4. Power off the monitor.

Move the QuantStudio™ 6 or 7 Flex System

Perform this procedure to safely move the QuantStudio™ 6 or 7 Flex System short distances (for example, between laboratories of the same building).



CAUTION! PHYSICAL INJURY HAZARD. Do not attempt to lift the QuantStudio™ 6 or 7 Flex System or any other heavy objects unless you have received related training. Incorrect lifting can cause painful and sometimes permanent back injury. Use proper lifting techniques when lifting or moving the QuantStudio™ 6 or 7 Flex System. At least two people are required to lift it.

IMPORTANT! Moving your QuantStudio™ 6 or 7 Flex System can create subtle changes in the alignment of the instrument optics. Recalibrate the instrument if necessary.

How to handle the sample block and heated cover

To prevent damaging or contaminating the sample block or the heated cover, handle the assemblies as shown below. After you remove each assembly from the QuantStudio™ 6 or 7 Flex System, place them on a clean, dry surface or in its shipping container.

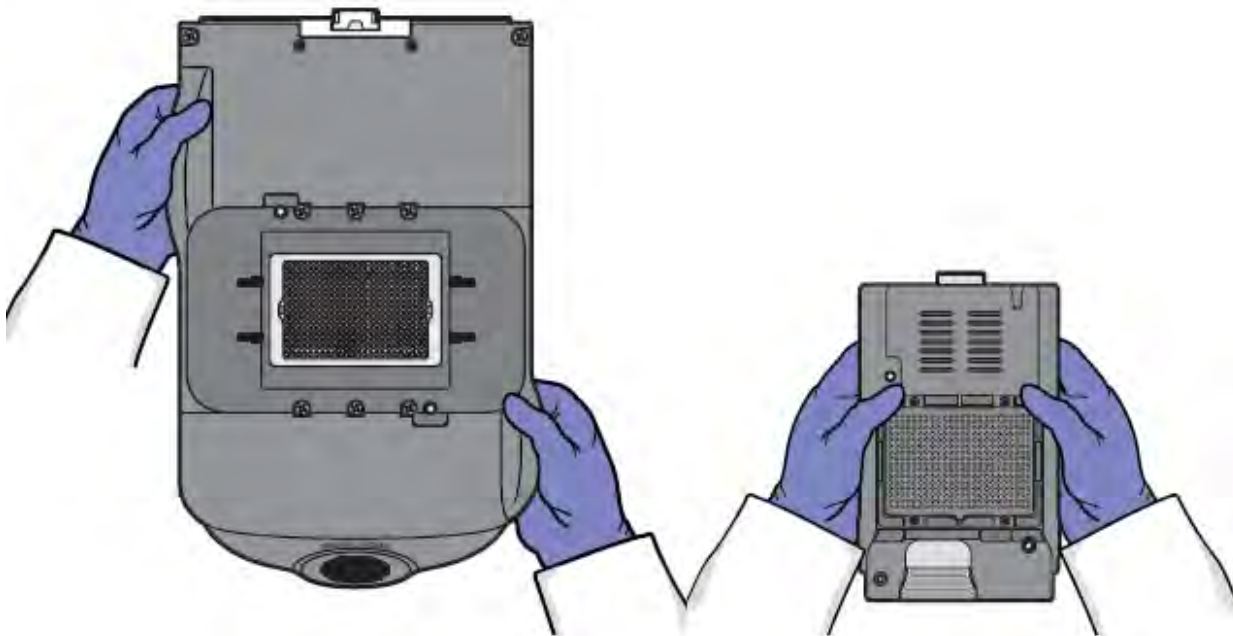

Prepare the QuantStudio™ 6 or 7 Flex System components

1. Power off the QuantStudio™ 6 or 7 Flex System and computer.
2. When the QuantStudio™ 6 or 7 Flex System and computer are powered off, disconnect all QuantStudio™ 6 or 7 Flex System components and package the cabling for the move.
3. Prepare the QuantStudio™ 6 or 7 Flex System for the move:
 - a. Open the QuantStudio™ 6 or 7 Flex System access door.
 - b. Firmly press down on the sample block handle, pull the sample block from the QuantStudio™ 6 or 7 Flex System, then place it on a clean, dry surface.
 - c. Pinch the handle of the heated cover together, then pull the assembly from the QuantStudio™ 6 or 7 Flex System and place it on a clean, dry surface.

- d. Package the sample block and heated cover assemblies in a clean, dust-free container.

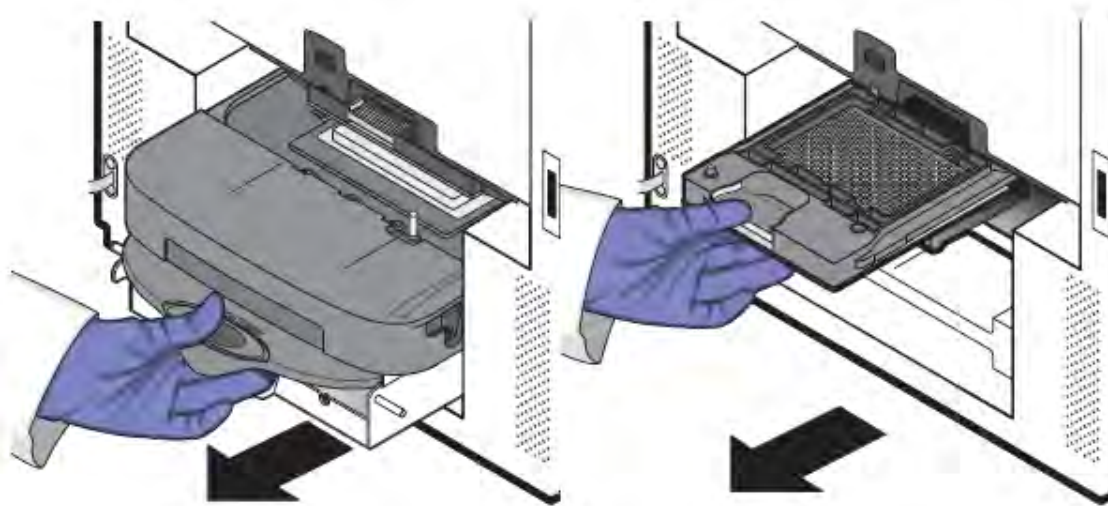

Move the QuantStudio™ 6 or 7 Flex System

Move the QuantStudio™ 6 or 7 Flex System according to the following guidelines:

- Ensure that the surface on which you will place the QuantStudio™ 6 or 7 Flex System can support at least 77.9 ± 0.6 kg (171.5 ± 0.13 lbs).
- Ensure that the path to transport the QuantStudio™ 6 or 7 Flex System is clear of obstructions.
- At least two people are needed to lift and carry the QuantStudio™ 6 or 7 Flex System.
- Keep your spine in a good neutral position.
- Bend at the knees and lift with your legs.
- Do not lift an object and twist your torso at the same time.
- Coordinate your intentions with your assistant before lifting and carrying.

Reinstall the QuantStudio™ 6 or 7 Flex System

1. Reconnect the components of the QuantStudio™ 6 or 7 Flex System. Use the Ethernet cable supplied with the instrument to connect the QuantStudio™ 6 or 7 Flex System to the network interface card in the computer.

IMPORTANT! Do not use a standard Ethernet cable to connect the QuantStudio™ 6 or 7 Flex System to the computer.

2. Install the sample block and heated cover assemblies.
3. Perform an RNase P instrument verification run. If the run:

Passes – Do not recalibrate the QuantStudio™ 6 or 7 Flex System. No further action is necessary.

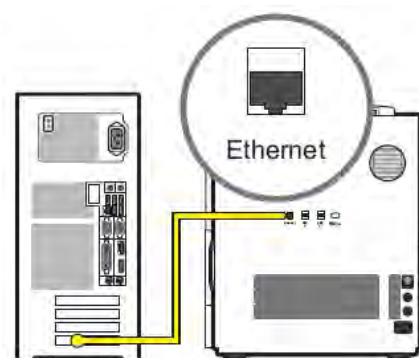



Fails – Perform the following calibrations in the specified order:

- a. ROI
- b. Background
- c. Uniformity
- d. Dye
- e. Normalization



Security, audit, and electronic signature

■ Administrator overview	132
■ Configure the security system	133
■ User account management	136
■ Audit trail management	140
■ Audit report generation	141
■ Manage electronic signature	145
■ Generate e-signature reports	148
■ Export and import user, security, audit, and e-signature settings	149
■ User overview	150

Administrator overview

IMPORTANT! Security, Audit, and Electronic Signature (SAE) is a separately licensed module available only on purchase. If your system requires this module, contact Thermo Fisher Scientific. The feature is disabled by default even after the installation of the license and needs to be enabled.

The Security, Audit, and Electronic Signature (SAE) module is a component of the QuantStudio™ Real-Time PCR Software that allows you to configure the QuantStudio™ 6 and 7 Flex Systems to meet specific requirements. The module provides the following functionality:

- **Security**— Controls user access to the software. A default Administrator user account is provided, and additional user accounts and permissions can be user-defined.

Note: You can enable or disable system security globally.

Note: The default password for the Administrator user account is *Administrator*; however, the password can be changed during installation.

- **Auditing** — Tracks changes made to library items, actions performed by users, and changes to the Security, Audit, and Electronic Signature settings. The software automatically audits some actions silently. You can select other items for auditing and specify the audit mode. The Auditing function provides reports for audited library items, Security, Audit, and Electronic Signature changes, and actions.

Note: You can enable or disable auditing globally and by record type.

- **Electronic signature (e-sig)**—Determines if users are required to provide a user name and password when performing certain functions. You can configure e-sig so that a user can print a report or start a run only if the associated data are signed. You can also configure each e-sig event to require multiple signatures and to require users with specific permissions to sign.

Note: You can enable or disable electronic signature globally.

Example applications

You can configure the Security, Audit, and Electronic Signature module in a variety of ways. For example, you can:

- Require users to log in, and leave audit disabled.
- Allow only certain users to create or modify protocols.
- Allow only certain users to approve reviewed samples.
- Require experiments to be signed before users can run or print them.

Configure the security system

Access the Security screen and enable or disable security

Use the **Security** screen to disable and enable security, control restrictions and security policies for all user accounts, and set up notifications when certain security events occur.

Note: Security is disabled by default.

To enable or disable security:

1. In the QuantStudio™ Real-Time PCR Software, select **Tools ▶ Security ▶ Settings**.
2. In the **Security Settings** dialog box, select the **System** tab.
3. Select or deselect **Enable Security**. Note the following:
 - The software requires you to enter your user name and password when you enable security.
 - The enable commands are grayed when a run is in process.
 - When security is disabled, the  is not active in lower parts of the screen.
 - Disabling Security inactivates Auditing and E-Signature.

IMPORTANT! If you disable security, you inactivate audit and electronic signature functions; however, no audit record is generated to indicate that audit and electronic signature functions are disabled.

IMPORTANT! If you enable or disable the QuantStudio™ Real-Time PCR Software security, auditing, and electronic signature feature, you must similarly enable or disable the QuantStudio™ 6 or 7 Flex Real-Time PCR System security (see “Enable or disable instrument security” on page 95). The software cannot connect to systems that do not match security settings.

4. Click **Apply Settings**.



Set account setup and security policies

Note: Security policies apply to all user accounts.

1. In the QuantStudio™ Real-Time PCR Software, select **Tools ▶ Security ▶ Settings**.
2. In **Account Setup**, specify **User Name** limits.

IMPORTANT! The software allows spaces in user names. Use spaces in user names with caution. For information, see “Spaces in user names and/or passwords” on page 134.

3. Specify User Password limits:
 - a. Specify the passwords length limits.
 - b. Specify password reuse. You cannot disable the password reuse restriction.
 - c. Specify the allowed characters in user passwords: spaces and alphabetical, numeric, uppercase, lowercase, and special characters (commas, periods, semicolons, dashes, underscores, and tildes).
4. In Security Policies, specify Password Expiration, Account Suspension, and Session Timeout settings.

Note: A session times out while a run is in progress if the time-out period is exceeded and there is no other user activity.

5. In the **Open Non-Secure Data** option, select **Yes** or **No** to determine whether users can open experiments and templates that were created without security settings.
6. Click **Set Up Messaging Notification Settings** to specify when and how the software notifies the administrator of certain security events. For information, see “Set up messaging notifications” on page 135.
7. Click **Apply Settings**.

The new settings are applied to the user account the next time that the user logs in.

Spaces in user names and/or passwords

If you allow spaces in user names and/or passwords, be aware of the following issues:

- Leading and trailing spaces in user names are difficult to detect on the screen or in printed reports.
- The number of consecutive spaces in a user name is difficult to determine on the screen or in printed reports.

Spaces in user names may cause confusion when a user searches for an audit record associated with a user name. To find a record associated with a user name, specify the user name exactly, including leading, consecutive, and trailing spaces.

Set up messaging notifications

1. In the QuantStudio™ Real-Time PCR Software, select **Tools ▶ Security ▶ Settings**.
2. In the **Security** screen, click **Set Up Messaging Notifications** to display the **Setup Notifications** dialog box.
3. Select the events for notification:
 - **System security enabled or disabled**—Security has been enabled or disabled.
 - **User did not enter correct password**—A user attempts to log in with an incorrect password. The message indicates the number of failed authentications.
 - **User account suspended**—The user exceeds maximum number of allowed failed authentications (login attempts with an incorrect password).
 - **User session timed out**—No activity occurred in a user account for the specified period of inactivity.
4. Select the notification method:
 - **Notify Admin at Login**—If an event triggers notification, the next time any user with an Administrator role logs in, the software lists those events, indicating the time each event occurred and the user who triggered the event.
The Administrator has the option of acknowledging the event, which removes it from the notification list.
 - **Email Notification**—If an event triggers notification, the QuantStudio™ Real-Time PCR Software sends an email to the addresses in the adjoining **Email Address** column of the table. The email notification displays the triggered event and displays the time that the event occurred and the user who triggered the event.
5. Click **OK**.



User account management

Create or edit user accounts

The software includes a default Administrator user account with permissions (defined by the account user role) to perform all functions in the software. You cannot modify this account.

1. In the QuantStudio™ Real-Time PCR Software, select **Tools ▶ Security ▶ Settings**.
2. In the **Security Settings** dialog box, select the **Users** tab. In the **Users** tab, you can perform the actions in the following table:

To...	Action
Create a user account	<ol style="list-style-type: none"> 1. Click Create to display the New User dialog box. 2. Enter user name, password, first name, middle initial (optional), and last name. Click a field to display the field limits, which are specified in Security settings. Note: First name, MI (middle initial), and last name are used to create User Full Name, which is displayed as the name of the logged-in user. Note: You cannot change the user name after you save the user account. 3. Select Password Expires at First Login to require the user account to specify a new password at first log in. The Password Expires On date is specified in Security settings. 4. Select the user role (described in “Create or edit a user role” on page 137) and the electronic signature state (determines if a user account has permission to electronically sign objects). Leave the status set to ACTIVE. 5. (Optional) Enter email (for information only), phone, and comments. 6. Click Save. A shaded Save button indicates an invalid entry in a field. Click a field to display the limits for the field, then enter a valid entry.
Edit a user account	<ol style="list-style-type: none"> 1. In the Users screen, select a user account, then click Edit. Note: If you select multiple users, only Status and Role will change. 2. Edit settings as needed. You cannot edit the user name of an existing user. 3. Click Save.
Activate a suspended user account	<ol style="list-style-type: none"> 1. In the Users screen, select the user. 2. Click Edit. 3. Change the Status from SUSPENDED to ACTIVE, then click Save.
Disable (inactivate) a user account	<p>IMPORTANT! You cannot delete a user, because user records are required for auditing. To disable a user account, inactivate it as follows.</p> <ol style="list-style-type: none"> 1. In the Users screen, select the user. 2. Click Edit. 3. Change the Status from ACTIVE to INACTIVE, then click Save.

(continued)

To...	Action
Reset a forgotten password	<ol style="list-style-type: none"> 1. In the Users screen, select the affected user account, then click Edit. 2. Enter a replacement password for the user, then re-enter the password for confirmation. 3. If you assigned the user a temporary password, then select Password Expires at First Login to require the user to specify a new password at log in. 4. Click Save.

Determine the name of the logged-in user

The title bar of the QuantStudio™ Real-Time PCR Software window displays the name of the user.

Create or edit a user role

User roles determine the permissions associated with a user account. The QuantStudio™ Real-Time PCR Software includes three default user roles:

- Administrator (cannot be edited or deleted)
- Scientist
- Technician

You can modify the Scientist and Technician roles, and you can create your own roles with customized settings as needed.

1. In the QuantStudio™ Real-Time PCR Software, select **Tools** ▶ **Security** ▶ **Settings**.
2. In the **Security Settings** dialog box, select the **Roles** tab.

From the **Roles** tab, you can perform the actions in the following table:

To...	Action
Create a user role	<ol style="list-style-type: none"> 1. Click Create. 2. Enter a role name and (optional) description. 3. Select permissions (see “Permissions and default user roles” on page 138). To select all permissions in a category, select the check box next to the category. Note: Operations not shown in the following table are available to all user roles. 4. Click Save Role.
Edit a user role	<ol style="list-style-type: none"> 1. In the Roles screen, select a user role, then click Edit. 2. Edit settings as needed. You cannot edit the Administrator user role. 3. Click Save Role.

Permissions and default user roles

Note: To determine the permissions for a default role or to edit it, select the role, then click **Edit**.

The following table shows all user-configurable permissions and the settings for the default user accounts.



Permissions		Default user roles		
Category	Function	Lab Director	Technologist	Administrator
Setup	Create and edit experiments or experiment templates (includes running experiments)	Yes	No	Yes
	Create, edit, and import sample attributes	Yes	No	Yes
Run	Perform a run using the Quickstart function	Yes	No	Yes
	Start a run	Yes	No	Yes
	Stop a run	Yes	No	Yes
Targets (Library)	Create targets	Yes	No	Yes
	Edit targets	Yes	No	Yes
	Delete targets	Yes	No	Yes
Analysis Settings (Library)	Create analysis settings (includes default settings)	Yes	No	Yes
	Edit analysis settings (includes default settings)	Yes	No	Yes
	Delete analysis settings	Yes	No	Yes
Run Methods (Library)	Create a run method	Yes	No	Yes
	Delete a run method	Yes	No	Yes
Dye (Library)	Create a custom dye	Yes	No	Yes
	Delete a dye	Yes	No	Yes
Study	Create or edit a study (for example, edit a plate or analysis settings)	Yes	No	Yes
	Add (transfer) experiments to a study	Yes	No	Yes
	Remove experiments from study	Yes	No	Yes
Preferences	Edit the system preferences	Yes	No	Yes
	Export the system preferences	Yes	No	Yes

(continued)

Permissions		Default user roles		
Category	Function	Lab Director	Technologist	Administrator
Preferences	Import the system preferences	Yes	No	Yes
Calibrations	Perform calibrations	Yes	Yes	Yes
RNaseP	Perform an RNase P run	Yes	Yes	Yes
Instrument Configuration	Add and remove instruments from monitoring	Yes	No	Yes
	Upgrade and downgrade instrument firmware	Yes	No	Yes
Security Configuration	Configure the security and audit feature	No	No	Yes
	Log in to user sessions that have timed out	No	No	Yes
	Perform E-Signing	Yes	No	Yes
Export	Export primary and secondary analysis results	Yes	Yes	Yes

View or print a user report

Note: The landscape and portrait functions are not available for the User or Roles reports. To print either report in landscape, save the report electronically (PDF), then print the file in the desired orientation.

1. In the QuantStudio™ Real-Time PCR Software, select **Tools ▶ Security ▶ Settings**
2. From the **Security Settings** dialog box, select the **Users** or **Roles** tab.
3. Click **View Report**.
4. From the **Report** screen, click tool bar options to manipulate the report as needed. Place the mouse pointer over an item for a description of the item.
5. Click  (**Print**) to print the report, or click  (**Save**) to save the report electronically (PDF).
6. Close the report.



Audit trail management

Access the audit screen and enable or disable auditing

Use the Audit screen to control the auditing state (disabled or enabled), the events that are audited, and the reasons available to users when audit mode is set to Prompt or Required.

Note: Auditing is disabled by default.

IMPORTANT! If you disable security, you inactivate audit and electronic signature functions; however, no audit record is generated to indicate that audit and electronic signature functions are disabled.

To enable auditing:

1. In the QuantStudio™ Real-Time PCR Software, select **Tools ▶ Security ▶ Settings**.
2. In the **Security Settings** dialog box, select the **Audit** tab.
3. Select or deselect **Enable Audit**.
4. Click **Apply Settings**.

Modify the auditing settings

To...	Action
Select objects to audit	<ol style="list-style-type: none"> 1. In the Audit Settings group of the Audit tab, select the objects to audit and the mode for each enabled item (Experiments, Experiment Templates, or Study). 2. Set the Audit Mode for each item you enable for auditing: <ul style="list-style-type: none"> • Optional – The event is audited, a reason prompt is displayed, but the user can cancel and continue without entering a reason. • Required – The event is audited, a reason prompt is displayed, and the user must specify a reason. • Silent – The event is audited, no reason prompt is displayed. 3. Click Apply Settings.
Create audit reason settings	<p>You can create, modify and delete the reasons that are available for selection in the Audit Reason dialog box (displayed when a user performs an audited action).</p> <ol style="list-style-type: none"> 1. To require users to select a pre-defined reason in the Audit Reason dialog box (displayed when a user performs an audited action), enable Require users to select a reason to change from the list. Users are not permitted to enter a reason. 2. As needed, click Create, or select a reason from the list, then click Edit or Delete.

Audit report generation

You can use the QuantStudio™ Real-Time PCR Software to generate reports of audit history from both the **Security Settings** dialog box and from open experiments, templates, or studies.

- View audit histories from the **Security Settings** dialog box (see page 141)
- View audit histories from an experiment, a template, or a study (see page 144)

Viewing audit histories from the security settings dialog box

1. In the QuantStudio™ Real-Time PCR Software, select **Tools ▶ Security ▶ Settings**.
2. In the **Security Settings** dialog box, select the **Audit** tab, then click **View Reports**.

Note: To access the **Audit Reports** screen, the user role for an account must have the **Configure the security and audit feature** permission. Users without the permission can view object audit histories for individual entries in the libraries by selecting entries, then clicking **View Audit History**.

From the **Audit Reports** dialog box, you can perform the actions in the following table:

To...	Action
Display audit histories	<ol style="list-style-type: none"> 1. Select a tab to display: <ul style="list-style-type: none"> • System Configuration History—Security, audit, and electronic signature configuration records, including audit history for each user account. • Action Record—System-specified audit events. 2. (Optional) Select Filter by, then filter the table: <ul style="list-style-type: none"> • Sort the table. • Specify filters (date range, user name, action, object or record type, object or record name, reason), then click Refresh. <p>Note: The Reason field in System Configuration History is not used.</p> <ul style="list-style-type: none"> • Select one or more records, then click View Report.
Review the action log	<p>The Action Record log lists system-specified audit events.</p> <p>All items in the action log are audited silently, except for the items noted as configurable. Configurable items may include comments in the action log.</p> <ul style="list-style-type: none"> • Audit Settings (Update) • Auditing Event (Archive, Restore, Purge) • Configuration (Import, Export) • Data Audit (Archive, Restore, Purge) • Login (Success, Failure) • Logout (Success) • Run (Start, Stop, Completed, Failed, Aborted, Error) • User Account (Create, Update)



(continued)

To...	Action
View and print audit reports	<ol style="list-style-type: none"> 1. Select the System Configuration History tab. 2. Display the records of interest. 3. Filter the list to decrease the time required to generate reports. IMPORTANT! You cannot cancel a report after you click a view button. 4. Click View Report. <p>Note: From the audit report, the Create action value is listed as Added, Delete action value is displayed as Removed, and Update action value is displayed as Updated.</p> <ol style="list-style-type: none"> 5. From the Report screen, click tool bar options to manipulate the report as needed. Place the mouse pointer over an item for a description of the item. <ul style="list-style-type: none"> • To print the report, click (Print). • To save the report electronically (PDF), click (Save). 6. Close the report.
Archive, purge, and restore audit records	<p>The audit archive function makes a copy of audit records. Purge makes a copy of audit records, and then deletes them. You can use the Restore function to restore purged audit records.</p> <p>Archive and purge</p> <p>To selectively archive or purge (delete) system configuration or action audit records:</p> <ol style="list-style-type: none"> 1. Select the System Configuration History tab. 2. Select records in the appropriate screen. 3. Click Archive or Purge. 4. If you select Archive, specify a location and name for the archive file (ASZ). <p>Restore</p> <p>To restore system configuration or action audit records, click Restore, then select the ASZ file to restore.</p>
Export audit records	<p>You can export audit records to a TXT file for additional manipulation and reporting outside the QuantStudio™ Real-Time PCR Software.</p> <ol style="list-style-type: none"> 1. Display the records of interest as described above. 2. Click Export. 3. Specify a name and location for the export TXT file, then click Save. <p>Note: If you export audit records for samples that have been deleted or moved, an error message is displayed. Return sample data files to their original location, then export again.</p>
Review the system configuration history	<p>The System Configuration History lists security, audit, and electronic signature configuration records.</p>

Review the system configuration history

The following table summarizes the actions that can be audited using the QuantStudio™ Real-Time PCR Software. The **System Configuration History** lists security, audit, and electronic signature configuration records.

Note: If you have installed additional modules to the software, then the list can contain additional auditable records.

Record type	Action	Corresponds to...
Security Settings	Update	Disable, enable, or modify security policies and session time-out settings
Account Settings	Update	Modify password settings, security policies (password expiration and account suspension), or user name settings
User Group Manager	Update	Create, delete, or modify reason for change
User Role	Create	Create user role
	Delete	Delete user role
	Update	Modify user role
User Account	Create	Create new user account
	Update	Edit or suspend a user account
Role Assignment	Delete	Assign a different user role to an existing user account
	Update	Create a user account, or assign a different user role to an existing account
Audit Settings	Update	Enable or disable auditing
Audit Type	Update	Modify audit settings
Function Management Settings	Update	Update function management
Function Access Manager	Update	Update function access management
Function	Create	Create function
	Delete	Delete function
	Update	Update function
Role Permissions	Create	Create a user role
	Delete	Delete a user role
	Update	Modify user role permissions
Audit Reason for Change	Delete	Create reason for change
	Update	Delete or modify reason for change



(continued)

Record type	Action	Corresponds to...
Event Manager	Update	Update the event manager
E-signature Manager	Update	Enable or disable e-signature
E-signature Type	Create	Create an e-signature meaning
	Delete	Delete an e-signature meaning
	Update	Edit an e-signature meaning or an e-signature action
E-signature Function	Update	Edit an action requiring e-signature
File Name	Update	Update the file name
File Version	Update	Update the file version



Viewing audit histories from an experiment, template, or study

1. In the QuantStudio™ Real-Time PCR Software, open an experiment (EDS), template (EDT), or study (EDM) file.
2. From the open file, click  **Audit**, then click **Audit Records**.
3. (*Studies only*) Select the audit records of interest:
 - **Study** to view the audit records for the study.
 - The name of an experiment to view the audit records for the experiment.

From the **Audit Records** screen of the open file, you can perform the actions in the following table:

To...	Action
Display the audit history	<p>(Optional) Filter the table.</p> <ol style="list-style-type: none"> 1. Check the Filter by check box. 2. Enter criteria for the records of interest, such as a date range, a user name, or a type of action. 3. Click Refresh. <p>To view details for a specific record:</p> <ol style="list-style-type: none"> 1. Click the row in the list on the left to view the details of the record in the table on the upper right. 2. Click any row to view details for individual records in the table on the bottom right.

(continued)

To...	Action
Export audit records	<ol style="list-style-type: none"> 1. From the table on the left, select the records to be exported: <ul style="list-style-type: none"> • Click in the table, then press Ctrl-A to select all the records in the table. • Click and drag or press Shift to select continuous rows. • Press Ctrl to select discontinuous rows. 2. Export the records: <ul style="list-style-type: none"> • Click Export Summary to export only the records in the left table. • Click Export Details to export the records in the left table and the associated details. 3. Select a location for the export file, enter a name for the file, then click Save. 4. Click OK in the confirmation message.
Print audit records	<ol style="list-style-type: none"> 1. Click View Summary Report to open the Print Preview dialog box. 2. Preview, save or print the report: <ul style="list-style-type: none"> • Click  (Save) to save the report as a PDF or HTML file. Enter the file name, select a location, select the file type, then click Save. • Click  (Print) to send the report to the printer. From the Print dialog box, select the printer and print options, then click OK. 3. Click  to close the Print Preview dialog box.

Manage electronic signature

Access the e-signature settings screen, and enable or disable the e-signature

Use the **Security** screen to disable and enable electronic signature.

Note: Electronic signature is disabled by default.

To enable or disable electronic signature:

1. In the QuantStudio™ Real-Time PCR Software, select **Tools ▶ Security ▶ Settings**.
2. In the **Security Settings** dialog box, select the **e-Signature** tab.

3. Select or deselect **Enable e-Signature**.

IMPORTANT! Enabling the electronic signature feature can substantially increase the size of experiment, template, and study files.

IMPORTANT! If you disable security, you inactivate audit and electronic signature functions. No audit record is generated for the disabling of audit and electronic signature functions when you disable security.

4. Click **Apply Settings**.

Configure the meanings of the electronic signatures

The e-signature meanings are the text that a user can select to describe a reason for an electronic signature. The QuantStudio™ Real-Time PCR Software is installed with the following default meanings.

E-Signature definition	Default data types			
	Plate setup	Thermal cycler protocol	Analysis protocol	Analysis results
Reviewed and Approved Plate Set Up	Yes	Yes	No	No
Reviewed and Approved Results	No	No	Yes	Yes
Reviewed and Approved Template	No	No	Yes	Yes

Use the **Security Settings** dialog box to add or remove electronic signature meanings and to determine the data types to which they apply.

To...	Action
Add a meaning	<ol style="list-style-type: none"> 1. In the e-Signature tab of the Security Settings dialog box, click Add in the e-Signature Meanings settings. 2. In the Create Meaning dialog box, enter a description of the e-Signature meaning, then click OK. 3. Select what data is signed for the selected meaning. 4. Click Apply Settings.
Delete a meaning	<ol style="list-style-type: none"> 1. Select the meaning from the e-Signature Meanings list, then click Remove. 2. Click Apply Settings.

Configure the e-signature rights for user roles

To determine the user roles that can perform an electronic signature:

1. From the e-Signature tab of the Security Settings dialog box, select the check box next to the appropriate user roles in the User Role signature rights table.
2. Click **Apply Settings**.

Select the actions that require signature

IMPORTANT! Do not change electronic signature settings during calibration.

1. In the **Signature Required** column, select the check box next to each action for which you want to require electronic signatures (see Figure 4 on page 147). This selection causes the software to present an e-sig prompt if a user performs the action on a data file that does not have the required signatures. The data must be signed before the user can perform the action.

Action	The software requires e-signatures when a user.
Print Report	Prints a report from an experiment or study.
Start Run	Initiates a run from the QuantStudio™ Real-Time PCR Software.

2. For each meaning of each selected action, enter the number of e-signatures from each user role that are required before the software can execute the associated action. For example, in the following figure, at least two users from the Administrator user role must sign an experiment using the “Reviewed and Approved Plate Set Up” meaning before a user can start the associated run.

Signature Required	Action
<input type="checkbox"/>	Print Report
<input checked="" type="checkbox"/>	Start Run

Number of signatures required for the selected action			
Meaning	Administrator	Technician	Scientist
Reviewed and Approved Plate Set Up	2	0	0
Reviewed and Approved Results	0	0	0
Reviewed and Approved Template	0	0	0

Figure 4 Actions requiring signatures

3. Click **Apply Settings**.

How the software prompts electronic signature

If the system is configured to check for a signature before starting a run or printing a report and the data are not signed, the QuantStudio™ Real-Time PCR Software displays a message when the user clicks **Start Run** or **Print Report**.

Example

The e-signature system is configured to require signatures from two users from the user account named Administrator before a user can start a run. The experiment has not been signed.

A user attempts to begin the run. The following message is displayed:





Before the run can start, two administrators must sign. If a user with an incorrect user role signs, the message is displayed again.

Generate e-signature reports

You can use the QuantStudio™ Real-Time PCR Software to generate reports of e-signature history from open experiment (EDS) or template (EDT) files.

Task	Description
Display the e-sig records	<ol style="list-style-type: none"> 1. In the QuantStudio™ Real-Time PCR Software, open an experiment or template file. 2. From the open experiment, click Audit, then click E-Signatures. 3. (Optional) Click any row to view details for individual signatures.
Save or print e-sig records	<ol style="list-style-type: none"> 1. In the QuantStudio™ Real-Time PCR Software, open an experiment or template file. 2. From the open experiment, click Audit then click E-Signatures. 3. In the table, select the record to be saved or printed. 4. Save or print the record: <ul style="list-style-type: none"> • Click (Save), select a location for the export file, enter a name for the file, then click Save. or • Click (Print). 5. Click OK in the confirmation message.

(continued)

Task	Description
Save or print the table of e-signature events	<ol style="list-style-type: none"> 1. In the QuantStudio™ Real-Time PCR Software, open an experiment or template file. 2. From the open file, click  Audit then click Print E-Signatures. 3. Save or print the record: <ul style="list-style-type: none"> • Click  (Save), select a location for the export file, enter a name for the file, then click Save. or • Click  (Print). 4. Click OK in the confirmation message.

Export and import user, security, audit, and e-signature settings

Note: The export/import feature can be used to replicate identical security, audit, and e-signature settings across multiple computers. The feature allows you to create a standard security, audit, and e-signature settings “image” for the QuantStudio™ Real-Time PCR Software that can then be imported by other copies of the software to bypass manual setup.

Task	Description
Export	<ol style="list-style-type: none"> 1. In any screen of the Security Settings dialog box, click Export. 2. Select the items to export: All or Custom. Custom contains select settings: <ul style="list-style-type: none"> • Users & Roles—All user accounts with Active status and all user roles and associated permissions (in case a user account specifies a user role that does not exist on the system into which you import the profiles). • System & Roles—All system settings and all user roles and associated permissions. 3. Click Export or OK. 4. When prompted, specify the name and location for the exported file (DAT), then click Save. A message is displayed when the export completes.
Import	<ol style="list-style-type: none"> 1. In any screen in the Security Settings dialog box, click Import in the Experiment Menu. 2. Select the DAT file to import, then click Open. A message is displayed asking if you want to overwrite the current system configuration. Click Yes. If any imported user accounts already exist on the system, you are prompted to overwrite or skip each account.



User overview

The Security, Audit, and Electronic Signature (SAE) module is a component of the QuantStudio™ Real-Time PCR Software that provides the following functionality:

- **System security**—Controls user access to the software.
- **Auditing**—Tracks changes made to library items, actions performed by users, and changes to the Security, Audit, and Electronic Signature settings.
- **Electronic signature**—Requires users to provide a user name and password when performing certain functions.

Depending on the way that your administrator configures these features, you may see the following dialog boxes and prompts when you use the software.

User account permissions

If your user account does not have permission to perform any function in the software, menu commands are shaded.

Account suspension

If the QuantStudio™ Real-Time PCR Software is configured to suspend a user account for failed logins, and if you repeatedly enter an incorrect user name and/or password, your user account is suspended, and the **Log In** dialog box indicates that your account is inactive.

There are two ways to activate a suspended account:

- You can wait until the suspension period ends.
- An administrator can change the account status from **Suspended** to **Active**.

Note: While a user is suspended, another user can click **Reset**, then log in and replace the suspended user.

Session time-out

If the QuantStudio™ Real-Time PCR Software is configured to time-out and there is no user activity for the specified time, the **Log In** dialog box indicates that your user session has timed out. You must enter your user name and password to access the software.

The administrator or another user with permission to log in to timed-out sessions can click **Reset**, then log in.

User security tasks

Task	Description
Log in	<p>Your access to functions in the software is based on the permissions associated with your user account. Functions for which you do not have permissions are shaded.</p> <p>Note: If the QuantStudio™ Real-Time PCR Software is configured for password expiration, you are periodically prompted to change your password.</p> <p>Note: If the QuantStudio™ Real-Time PCR Software is configured to monitor failed log in attempts, you will be locked out of the software if you repeatedly enter an incorrect user name and/or password.</p>
Change your password when it expires	<p>When your password is about to expire, a message is displayed when you log in.</p> <p>To change your password, select Tools ▶ Change Password. Enter your current password, then enter the new password two times, then click OK.</p>
Enter a reason for change	<p>If the QuantStudio™ Real-Time PCR Software is configured for auditing, you may be prompted to specify a reason when you make certain changes in the software.</p> <p>Depending on your QuantStudio™ Real-Time PCR Software configuration, you can either select a reason from the list or enter a reason for change.</p>
Perform an electronic signature	<p>If your system is configured for electronic signature, you may be required to have the experiment signed by other users before you can print a report or start a run. If an item is set to require multiple signatures, all approvers must sign the associated data before the action can be completed.</p> <p>If electronic signature is enabled for experiments, any of the following may apply:</p> <ul style="list-style-type: none"> • The Tools ▶ Security ▶ Sign Data menu option is enabled. • You are prompted to sign.



Calibration consumable preparation

- Create a background plate or array card 152
- Create a custom dye plate for calibration 154

Create a background plate or array card

Whenever possible, use a Background Plate or the TaqMan™ Array Background Buffer that is included with the spectral calibration kit. The plates/array cards supplied in the kit contain a buffer that accurately simulates the reagents used for PCR, and, therefore, produces high-quality calibration data. If a background plate or array card from a spectral calibration kit is not available, you can create one as described below.

Required materials

96/384-Well plate sample block

- MicroAmp™ Optical 96/384-Well Reaction Plate
- Safety glasses
- Optical Adhesive Cover or Optical Flat Caps
- Pipettor, 200- μ L (with pipette tips)
- Powder-free gloves
- Deionized water

TaqMan™ Array Card block (*QuantStudio™ 7 Flex System only*)

- TaqMan™ Array Cards
- TaqMan™ Array Card Sealer
- Centrifuge with array card buckets and array card carrier clips
- Permanent marker or pen
- Pipettor, 200- μ L (with pipette tips)
- Powder-free gloves
- Safety glasses
- Deionized water

Create a background plate

IMPORTANT! Wear powder-free gloves while creating the background plate.

1. Remove a MicroAmp™ 96/384-Well Optical Reaction Plate from its box and place it on a clean, dry surface.
2. Aliquot deionized water to each well of the reaction plate.
 - 96-well, 0.2-mL: 50 µL
 - 96-well, 0.1-mL: 30 µL
 - 384-well: 20 µL
3. Seal the plate using an optical adhesive cover or optical flat caps.
4. Use the plate for background calibration as you would a background plate from the spectral calibration kit.

Create a background array card (*QuantStudio™ 7 Flex System only*)

1. Remove an array card from its box and place it on a clean, dry surface.
2. Using a permanent marker, write “Background” on the side of the empty card.
3. Pipet 100 µL of deionized water into each of the eight reservoirs in the card:
 - a. Place the array card on a lab bench, with the foil side down.
 - b. Load 100 µL of the solution into a pipette.
 - c. Hold the pipette in an angled position (~45°) and place the tip into the fill port.

There is a fill port on the left arm of each fill reservoir – the larger of the two holes.

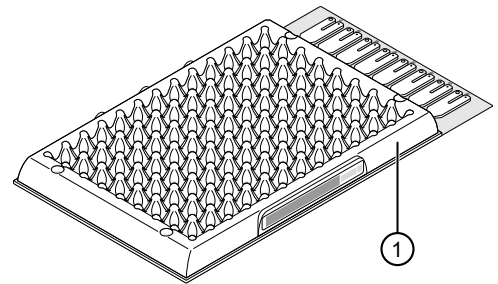

① Mark here

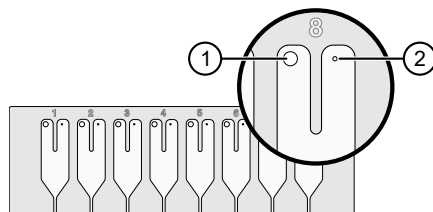

① Fill port

② Vent port

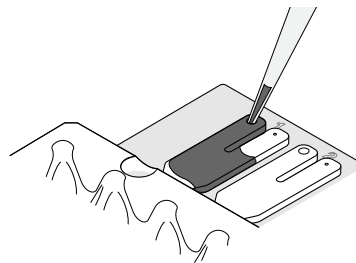

- d. Dispense the fluid so that it sweeps in and around the fill reservoir toward the vent port.

When pipetting the reagents into the array card, pipet the entire 100- μ L volume into the fill reservoir, but *do not* go past the first stop of pipettor plunger or you may blow the solution out of the port.

IMPORTANT! Do not allow the tip to contact and possibly damage the coated foil beneath the fill port.

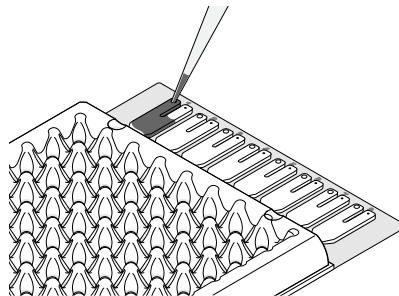

4. Centrifuge and seal the array card as explained in “Fill the calibration TaqMan™ Array Cards” on page 34.

Create a custom dye plate for calibration

The QuantStudio™ 6 or 7 Flex System can be used to run assays designed with custom dyes (dyes not manufactured by Thermo Fisher Scientific). Custom dyes must excite between 455 and 672 nm and read between 505 and 723 nm.

Before you use custom dyes

Before using custom dyes with the QuantStudio™ 6 or 7 Flex System, you must:

- Determine optimum dye concentration.
- Create a custom dye plate.
- Add the custom dye to the software.
- Perform a dye calibration.

Required materials

- Centrifuge with plate adapter
- Custom dye(s)
- Safety glasses
- Powder-free gloves
- MicroAmp™ Optical 96/384-Well Reaction Plate
- Optical Adhesive Cover
- Pipettors and pipette tips (200- μ L and 1000- μ L)
- Tubes (2-mL and 10-mL)
- Deionized water

Determine optimum dye concentration

Note: Wear powder-free gloves while creating the dye plate.

1. Prepare and load the custom dye plate:
 - a. In the center of a 96- or 384-well plate, prepare a dilution series of the custom dye (for example, 25, 50, 100, 200, 400, 800, 1600, and 3200 nM).
Use the following volumes:
 - 96-well, 0.2-mL: 50 μ L
 - 96-well, 0.1-mL: 30 μ L
 - 384-well: 20 μ L
 - b. Seal the reaction plate using an optical adhesive cover.
 - c. Load the prepared reaction plate.
2. Start the calibration wizard:
 - a. In the **Home** screen of the QuantStudio™ Real-Time PCR Software, click **Instrument Console**.
 - b. In the **Instrument Console**, select your system, then click **Add to My Instruments**.
 - c. Select the system, then click **Manage Instrument**.
 - d. In the **Instrument Manager**, click **Maintenance**, then click **ROI**.
 - e. In the **ROI Calibration** screen, click **Start Calibration**.
 - f. In the **ROI dialog** box, click **Next** until prompted to load the system. When the side door opens, load the sealed plate. Ensure that the plate or the array card is properly aligned in the holder.
 - g. In the **ROI dialog** box, select **Check the box when the ROI calibration plate has been loaded**, click **Next** twice, then click **START RUN** to start the calibration.
3. When the run is complete, inspect the ROI images:
 - a. Select the first filter from the **Filter** drop-down list.
 - b. Record the coordinate of the well that contains the lowest concentration of dye and that is encircled by a ring. This well contains the optimal concentration of the custom dye at the given filter.
 - c. Repeat steps a and b for the remaining filters.
 - d. After you determine the optimum concentration for each filter, determine the optimum concentration for the custom dye. Compare the results from all filters, then select the concentration that yields the highest possible signal in all filters.

- Discard the plate.



WARNING! PHYSICAL INJURY HAZARD. During instrument operation, the plate can reach 100°C. Allow the plate to reach room temperature before removing.

- In the **ROI** dialog box, click **Finish** to complete the calibration, then click **No** when prompted to save the results.

Create a custom dye plate

IMPORTANT! Wear powder-free gloves while creating the dye plate.

- Prepare the custom dye at the concentration determined in “Determine optimum dye concentration” on page 155.
 - 96-well, 0.2-mL: 5 mL
 - 96-well, 0.1-mL: 3 mL
 - 384-well: 8 mL
- Pipet the diluted custom dye to all wells of an optical reaction plate.
 - 96-well, 0.2-mL: 50 µL
 - 96-well, 0.1-mL: 30 µL
 - 384-well: 20 µL
- Seal the wells of the reaction plate using an optical adhesive cover.
- Centrifuge the plate for 2 minutes at <1500 rpm.

Note: The custom dye calibration plate must be well mixed and centrifuged.

- Verify that the liquid in each well of the plate is at the bottom of the well. If not, centrifuge the plate again at a higher rpm and for a longer period of time.

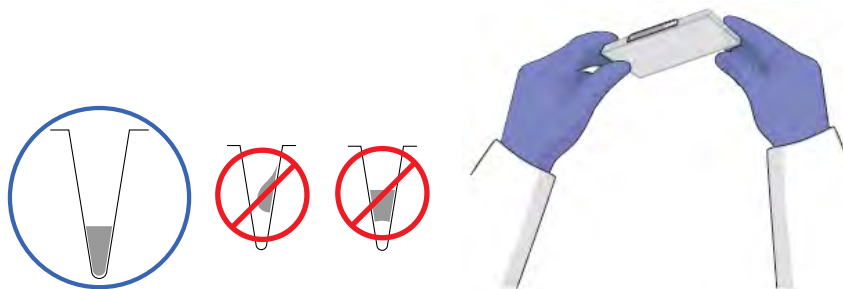

Add the custom dye to the software

- Start the dye calibration:
 - In the **Home** screen of the QuantStudio™ Real-Time PCR Software, click **Instrument Console**.

- b. In the **Instrument Console**, select your system from the list of instruments on the network, then click **Add to My Instruments**.
 - c. Select the system, then click **Manage Instrument**.
 - d. In the **Instrument Manager**, click **Maintenance**, then click **Dye**.
 - e. In the **Background Calibration** screen, click **Start Calibration**.
2. In the **Dye** window, select a custom dye from the list or create the custom dye:
 - a. Click **New Dye**.
 - b. In the **Dye Library** dialog box, click **New**.
 - c. Complete the **New Dye** dialog box, then click **OK**.

Field/option	Action
Name	Enter a name for the custom dye.
Wavelength	Enter the wavelength at which the dye fluoresces.
Type	Select: <ul style="list-style-type: none"> • Reporter if the dye works in conjunction with a quencher dye to report an increase of PCR product. • Quencher if the dye suppresses the fluorescence of a reporter dye until amplification of PCR product. • Both if the dye reports an increase of PCR product without the aid of a quencher dye.

- d. Click **Close**.
3. In the **Dye** window, enter a temperature setting for the calibration. Set the temperature to match the temperature at which you intend to collect data. For example, the temperature for all system dyes is 60°C because data collection for TaqMan™ reagents occurs during the 60°C extension step of the PCR.
 4. Load the appropriate dye plate into the plate adapter, select **Please check the box when the dye calibration plate has been loaded**, click **Next** twice, then click **START RUN** to start the calibration.
 5. When the run is complete and the system ejects the plate, remove and discard the plate or the array card.



WARNING! PHYSICAL INJURY HAZARD. During instrument operation, the plate can reach 100°C. Allow the plate to reach room temperature before removing.

6. In the **Dye** dialog box of the QuantStudio™ Real-Time PCR Software, click **Next**.
7. Verify the grouping of the dye spectra:
 - a. In the plate layout, select the wells of the plate.



- b. Inspect the raw data. For each spectrum, verify that the peak is:
 - Within the detectable range for the system.
 - Free of irregular spectral peaks.
 - Present at the correct filter for the dye.

Note: Among wells containing the same dye, variations in spectral position and peak position are caused by minor differences in the optical properties and excitation energy between the individual wells.

8. Verify the status of the calibration. If the calibration:

Passed—If all spectra are acceptable, finish the calibration:

- a. Click **Next**.
- b. Enter any comments you have in the **Comments** field, click **Finish**, then click **Yes** when prompted to save the calibration results.

Failed—Create another custom dye plate using the next dye concentration greater than the concentration determined in “Determine optimum dye concentration” on page 155, then perform the calibration again.



Parts and materials

■ How to order	159
■ Kits, consumables, and accessories	160
■ General-use materials and consumables	164

How to order

You can order materials and accessories directly from thermofisher.com.

Note: Product availability and pricing may vary according to your region or country. Online ordering through thermofisher.com is not available in all countries. Contact your local Thermo Fisher Scientific representative for help.

To order through the website or the QuantStudio™ Real-Time PCR Software:

- Confirm that your computer has an Internet connection.
- We recommend the following browsers and Adobe™ Acrobat™ Reader versions to use thermofisher.com:

Operating system	Microsoft™ Internet Explorer™	Apple Safari™	Mozilla™ Firefox™	Adobe™ Acrobat™ Reader
Microsoft™ Windows™	v6.x or Later	None ^[1]	v2.x or Later	v4.0 or Later
Macintosh™	None ^[1]	v2.0.4 or Later		

^[1] Browser not available for this platform.

Note: Confirm that cookies and JavaScript are turned on for the website to function correctly.

How to order from the system software

1. To find your assay, complete the **Find Assay** pane in the QuantStudio™ Real-Time PCR Software:
 - a. Enter a gene name in the **Enter Gene Name** field, then click **Find Assay**.
 - b. In the **Find Assay Results** dialog box, select your assay.
 - c. Click **Apply Assay Selection**. The selected assay is added to your shopping list.

2. Check that the **Experiment Shopping List** contains the desired materials, other than the assay selected in the previous step, and that the quantities are correct, then click **Order Materials in List**.
3. In the **Order Materials - Login** dialog box, enter your user name and password for the store, then click **Log In and Submit**.

Order Materials - Login

Log into the Applied Biosystems Store to place the selected items in your shopping basket. If you do not have a user name and password, click "Register Now" to create a new account.

Store Log In

To log into the Applied Biosystems Store, enter your user name and password then click "Log In and Submit".

User Name:

Password:

Log In and Submit **Cancel**

OR

Register

If you do not have an Applied Biosystems account, click the link below to create a new account.

[Register Now](#)

Remember my user name and password for future orders

Note: If you do not have an account with thermofisher.com, click **Register Now** to create an account.

When you are connected to thermofisher.com, follow the prompts to complete your order.

Kits, consumables, and accessories

The following kits, consumables, and reagents are to be used with the QuantStudio™ 6 and 7 Flex Systems.

- 96-well 0.1-mL consumables (page 161)
- 96-well 0.2-mL consumables (page 161)
- 384-well consumables (page 162)
- TaqMan™ Array Card consumables (page 162)
- QuantStudio™ 6 and 7 Flex Systems accessories (page 163)

Note: For reagent or consumable shelf-life expiration date, see the package label.



Note: The QuantStudio™ 6 Flex System does not support the Array Card block.

96-well 0.2-mL consumables

Consumable	Cat. No.	Storage	Shelf life at storage temperature
Standard Calibration Install Kit, 96-well (Includes all of the items listed below)	4432488	-25°C to -15°C	Use the consumable by the expiration date on the packaging.
FAM™ Dye Spectral Calibration Plate, 96-well	4432327		
VIC™ Dye Spectral Calibration Plate, 96-well	4432334		
ROX™ Dye Spectral Calibration Plate, 96-well	4432340		
TAMRA™ Dye Spectral Calibration Plate, 96-well	4432352		
Region of Interest (ROI) and Background Plates, 96-Well 0.2-mL (2 plates)	4432364		
Normalization Plates with FAM™/ROX™ and VIC™/ROX™ Dyes , 96-well	4432370		
TaqMan™ RNase P Instrument Verification Plate, 96-Well 0.2-mL	4432382		

96-well 0.1-mL consumables

Consumable	Cat. No.	Storage	Shelf life at storage temperature
Calibration Install Kit, Fast 96-well (Includes all of the items listed below)	4432557	-25°C to -15°C	Use the consumable by the expiration date on the packaging
FAM™ Dye Spectral Calibration Plate, Fast 96-well	4432389		
VIC™ Dye Spectral Calibration Plate, Fast 96-well	4432396		
ROX™ Dye Spectral Calibration Plate, Fast 96-well	4432402		
TAMRA™ Dye Spectral Calibration Plate, Fast 96-well	4432414		
Region of Interest (ROI) and Background Plates, Fast 96-Well 0.1-mL (2 plates)	4432426		
FAM™/ROX™ and VIC™/ROX™ Dye Normalization Plates, Fast 96-well	4432432		
TaqMan™ RNase P Instrument Verification Plate, Fast 96-Well	4351979		



384-well consumables

Consumable	Cat. No.	Storage	Shelf life at storage temperature
Calibration Install Kit, 384-well (Includes all of the items listed below)	4432470	-25°C to -15°C	Use the consumable by the expiration date on the packaging.
FAM™ Dye Spectral Calibration Plate, 384-well	4432271		
VIC™ Dye Spectral Calibration Plate, 384-well	4432278		
ROX™ Dye Spectral Calibration Plate, 384-well	4432284		
TAMRA™ Dye Spectral Calibration Plate, 384-well	4432296		
Region of Interest (ROI) and Background Plates, 384-well	4432320		
FAM™/ROX™ and VIC™/ROX™ Dye Normalization Plates, 384-well	4432308		
TaqMan™ RNase P Instrument Verification Plate, 384-well	4455280		

TaqMan™ Array Card consumables

Consumable	Cat. No.	Storage	Shelf life at storage temperature
Array Card Calibration Install Kit (Includes the ViiA™ 7 Array Card Spectral Calibration Kit and the ViiA™ 7 Array Card RNaseP Verification Kit)	4432250	-25°C to -15°C	Use the consumable by the expiration date on the packaging.
ViiA™ 7 Array Card Spectral Calibration Kit, includes the following components: <ul style="list-style-type: none"> • Empty TaqMan™ Array Cards • FAM™ dye • VIC™ dye • ROX™ dye • ROI dye mix • Background buffer • FAM™/ROX™ dye • VIC™/ROX™ dye 	4432314		



(continued)

Consumable	Cat. No.	Storage	Shelf life at storage temperature
<p>ViiA™ 7 Array Card RNaseP Verification Kit, includes the following components:</p> <ul style="list-style-type: none"> • TaqMan™ Array Card • Eight (8) vials of RNase P detection reagents, one for each port in the TaqMan™ Array Card. Each vial contains the following reagents: <ul style="list-style-type: none"> – PCR master mix – RNase P primers – A FAM™ dye-labeled probe – A known concentration of human genomic DNA template 	4432265	–25°C to –15°C	Use the consumable by the expiration date on the packaging.

Note: The Array Card block consumables are applicable only to the QuantStudio™ 7 Flex System.

QuantStudio™ 6 and 7 Flex Systems accessories

Accessory	Cat. No.
384-Well Plate/Array Card Heated Cover	4454163
384-Well Plate Sample Block	4454165
96-Well Plate Heated Cover	4459841
96-Well Plate Sample Block	4459839
Array Card Bucket/Clip Set	4452205
Array Card Sample Block	4454164
Fast 96-Well Plate Heated Cover	4459842
Fast 96-Well Plate Sample Block	4459840
Halogen lamp (12 V, 75 W)	4480914
Handheld Barcode Scanner	4453271
TaqMan™ Array Card Sealer	4331770



QuantStudio™ 6 and 7 Flex Systems empty™ plates and array cards

Consumable	Cat. No.
96-Well Fast Plate (empty), 10-pack	4346907
96-Well Fast Plate with Barcode (empty), 10-pack	4346906
96-Well Plate (empty), 10-pack	N8010560
96-Well Plate with Barcode (empty), 10-pack	4306737
Adhesive Seal Applicator Kit, 5-pack	4481196
Array Card Kit (empty), 1-pack ^[1]	4445702
Array Card Kit (empty), 4-pack ^[1]	4445701
Optical Adhesive Covers, 25-pack	4481193

^[1] QuantStudio™ 7 Flex System only.

General-use materials and consumables

The following general-use materials and consumables are required to calibrate, maintain, and operate the QuantStudio™ 6 and 7 Flex Systems. "MLS" indicates that the material is available from fisherscientific.com or another major laboratory supplier.

Material/consumable	Source
Bleach, 10% solution	MLS
Centrifuge with 96-well plate buckets	MLS
Cotton or nylon swabs and lint-free cloths	MLS
Ethanol, 95% solution	MLS
Optical clear adhesive film for PCR	MLS
Pipettors, 100- μ L and 200- μ L (with pipette tips)	MLS
Powder-free gloves	MLS
Safety glasses	MLS
Screwdriver, flathead	MLS
Tissue, lint-free	MLS
Deionized water	MLS



Instrument specification and layout

- QuantStudio™ 6 and 7 Flex Systems specifications 165
- QuantStudio™ 6 and 7 Flex Systems layout and connections 169

QuantStudio™ 6 and 7 Flex Systems specifications

For more information, see the *QuantStudio™ 6 and 7 Flex Real-Time PCR Systems Site Preparation Guide* (Pub. No. 4489824).

Component	Height	Depth	Width	Weight
Instrument ^[1]	75.0 cm (29.5 in.)	70.0 cm (27.6 in.)	53.0 cm (20.9 in.)	70 kg (154.3 lbs)
Computer	56.5 cm (22.3 in.)	54.7 cm (22.4 in.)	21.6 cm (8.5 in.)	10 kg (22.0 lbs)
Monitor	38.0 cm (15.0 in.)	13.7 cm (5.4 in.)	37.4 cm (14.7 in.)	3.0 kg (6.7 lbs)
Keyboard	2.75 cm (1.1 in.)	44.5 cm (17.8 in.)	13.75 cm (5.5 in.)	0.75 kg (1.65 lbs)

^[1] Weight varies depending on the sample block installed.

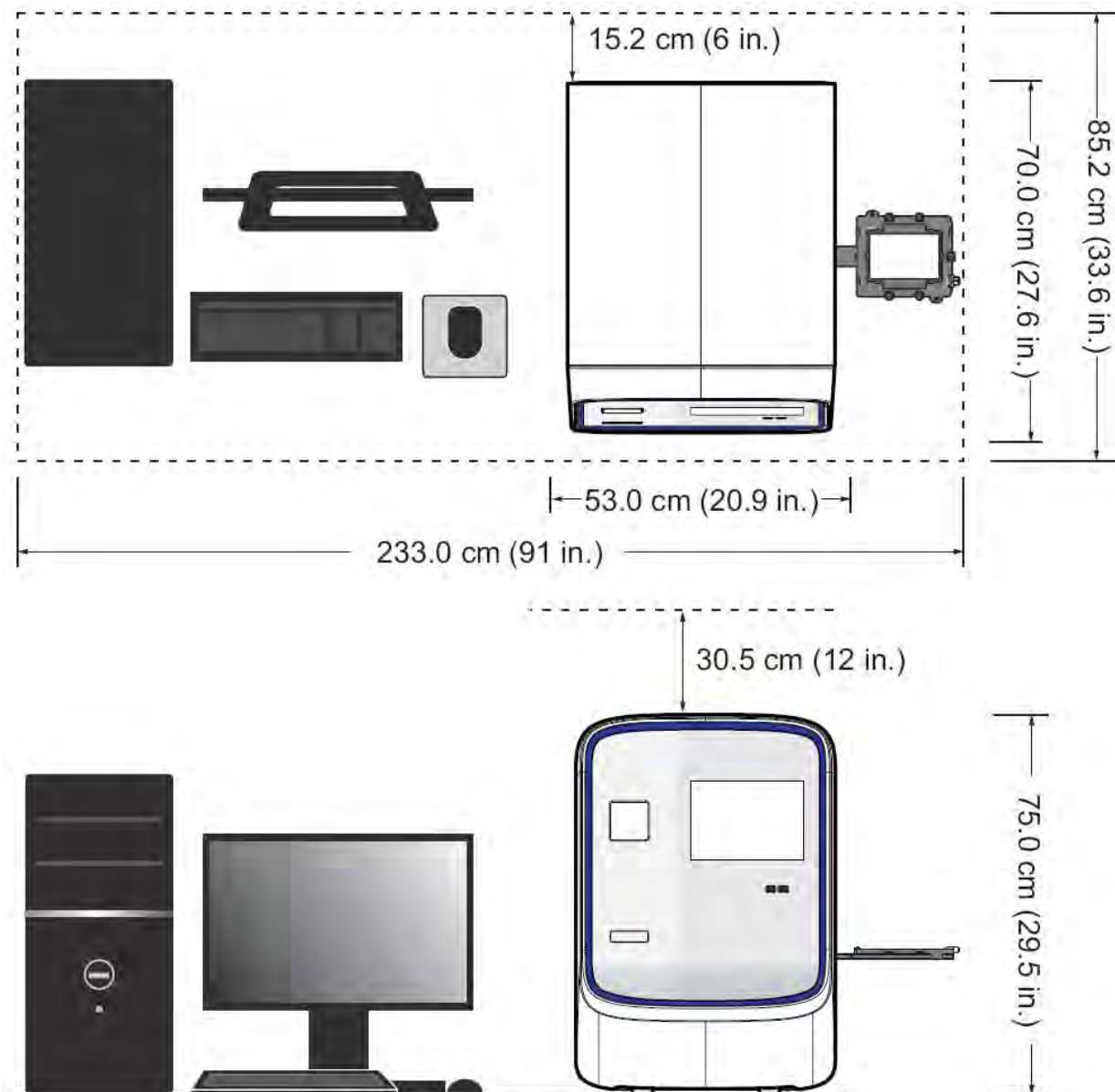



Required clearances

During instrument setup and maintenance, it is necessary to access the back and sides of the instrument. If the back of the instrument faces a wall, it will be necessary to have enough space to rotate the instrument on the bench for access.

IMPORTANT! For safety, the power outlet used for powering the instrument must be accessible at all times.

Component	Top	Front	Sides	Back
Instrument	30.5 cm (12.0 in.)	122 cm (48.0 in.)	51.0 cm (20.0 in.)	15.2 cm (6.0 in.)
Computer	—	30.5 cm (12.0 in.)	—	15.2 cm (6.0 in.)

Electrical requirements



WARNING! For safety, the power outlet used for powering the instrument must be accessible at all times. See “Required clearances” on page 167 for information about the space needed between the wall and the instrument. In case of emergency, you must be able to immediately disconnect the main power supply to all the equipment. Allow adequate space between the wall and the equipment so that the power cords can be disconnected in case of emergency.

Note: Place the instrument and computer power receptacle on an electrical circuit that is not shared with electrically noisy devices or devices that can cause power surges, such as refrigeration units.

The following table provides electrical specifications for the instrument and associated devices. For all indicated input voltages, a 15 A circuit is required.

Device	Rated current	Rated power	Rated voltage	Rated frequency
Instrument	12.5 A	950 VA	100–240 ± 10% VAC	50/60 Hz
Computer	2.1 A	125 VA		
Monitor	1.5 A	65 VA		

Note: The instrument, monitor, and computer self-adjust for 100–240 V input voltages of 50/60 Hz.



Environmental requirements

Condition	Description
Altitude	Located between sea level and 6000 ft (~1800 m) above sea level
Electromagnetic interference	Do not use this device in close proximity to sources of strong electromagnetic radiation (for example, unshielded intentional RF sources). Strong electromagnetic radiation may interfere with the proper operation of the device.
Humidity	15–80% (noncondensing)
Installation site	For indoor use only
Pollution	The instrument has a Pollution Degree rating of II. The instrument may only be installed in an environment that has nonconductive pollutants such as dust particles or wood chips. Typical environments with a Pollution Degree II rating are laboratories and sales and commercial areas. The noise output of the instrument is <60 dB at idle.
Temperature	15–30°C (60–85°F)
Thermal output	During operation the net thermal output, based on the actual current draw of the instrument and computer, is expected to be approximately 2731 BTU/hour [800 W].
Vibration	Ensure that the instrument is not adjacent to strong vibration sources, such as a centrifuge, pump, or compressor. Excessive vibration will affect instrument performance.
Other conditions	Ensure the room is away from any vents that could expel particulate material on the instrument components. Avoid placing the instrument and computer adjacent to heaters, cooling ducts, or in direct sunlight.

Network requirements

The computer is factory-configured for the TCP/IP protocol. The product includes a fast Ethernet adapter (10/100 Mbps) with an RJ45-type connector and one 3-m (9.8-ft) crossover Ethernet cable that connects the computer and the instrument.

If the instrument will be connected to a LAN, an active, tested LAN connection must be in place before the scheduled installation date. Due to differences in network connections, the service representative cannot configure the instrument to access a specific network.

You must supply a standard Category 5 Ethernet cable of the required length to connect the computer to your LAN.

QuantStudio™ 6 and 7 Flex Systems layout and connections

The QuantStudio™ 6 and 7 Flex Systems consist of the components in the following figure.

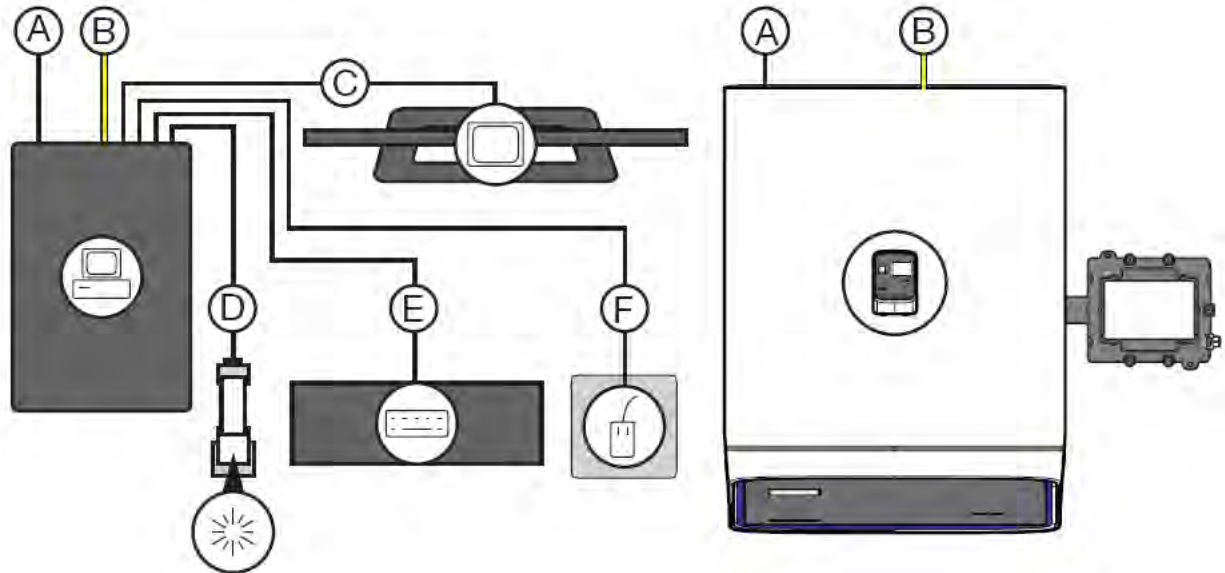

	Component	Description
	QuantStudio™ 6 or 7 Flex Real-Time PCR System	Performs fluorescence detection and data collection of experiment and calibration plates or array cards.
	Computer	Run the QuantStudio™ Real-Time PCR Software that is used to: <ul style="list-style-type: none"> • Calibrate the systems. • Set up experiments. • (Optional) Run experiments. • Analyze experiments.
	Monitor	
	Keyboard	
	Mouse	
	Barcode scanner	Scans the barcodes of plates and array cards.

	Connection	Description
A	Power cables	Supply power to the computer and the QuantStudio™ 6 and 7 Flex Systems. ^[1]
B	LAN connection or Ethernet cable ^[2]	Connects the QuantStudio™ 6 and 7 Flex Systems (Ethernet port) to the Ethernet port on the network interface card in the computer. The components can be connected over a local area network or a via a direct physical connection.



(continued)

	Connection	Description
C	DVI cable	Connects the monitor to the computer (DVI port).
D	Barcode scanner cable	Connects the optional barcode scanner to the computer (USB port).
E	Keyboard cable	Connects the keyboard to the computer (USB port).
F	Mouse cable	Connects the mouse to the computer (USB port).

[1] Supplies 115/230 V depending on the geographic location of the installation.

[2] Supplied with the QuantStudio™ 6 and 7 Flex Systems.



Safety

■ Symbols on this instrument	171
■ Safety information for instruments not manufactured by Thermo Fisher Scientific	176
■ Instrument safety	176
■ Laser safety—barcode scanner	178
■ Workstation safety	179
■ Safety and electromagnetic compatibility (EMC) standards	179
■ Chemical safety	181
■ Biological hazard safety	182



WARNING! GENERAL SAFETY. Using this product in a manner not specified in the user documentation may result in personal injury or damage to the instrument or device. Ensure that anyone using this product has received instructions in general safety practices for laboratories and the safety information provided in this document.

- Before using an instrument or device, read and understand the safety information provided in the user documentation provided by the manufacturer of the instrument or device.
- Before handling chemicals, read and understand all applicable Safety Data Sheets (SDSs) and use appropriate personal protective equipment (gloves, gowns, eye protection, and so on). To obtain SDSs, visit [thermofisher.com/support](https://www.thermofisher.com/support).





Symbols on this instrument





Symbols may be found on the instrument to warn against potential hazards or convey important safety information. In this document, the hazard symbol is used along with one of the following user attention words.

- **CAUTION!**—Indicates a potentially hazardous situation that, if not avoided, may result in minor or moderate injury. It may also be used to alert against unsafe practices.
- **WARNING!**—Indicates a potentially hazardous situation that, if not avoided, could result in death or serious injury.
- **DANGER!**—Indicates an imminently hazardous situation that, if not avoided, will result in death or serious injury.





Standard safety symbols



Symbol and description	
	CAUTION! Risk of danger. Consult the manual for further safety information.
	CAUTION! Risk of electrical shock.
	CAUTION! Hot surface.
	CAUTION! Potential biohazard.
	CAUTION! Ultraviolet light.

Symbole et description	
	MISE EN GARDE ! Risque de danger. Consulter le manuel pour d'autres renseignements de sécurité.
	MISE EN GARDE ! Risque de choc électrique.
	MISE EN GARDE ! Surface chaude.
	MISE EN GARDE ! Danger biologique potentiel.
	MISE EN GARDE ! Rayonnement ultraviolet.



Additional safety symbols

Symbol and description	
	CAUTION! Laser radiation
	CAUTION! Moving parts.
	CAUTION! Potential slipping hazard.

Symbole et description	
	MISE EN GARDE ! Laser radiation
	MISE EN GARDE ! Parties mobiles.
	MISE EN GARDE ! Danger de glisser potentiel.





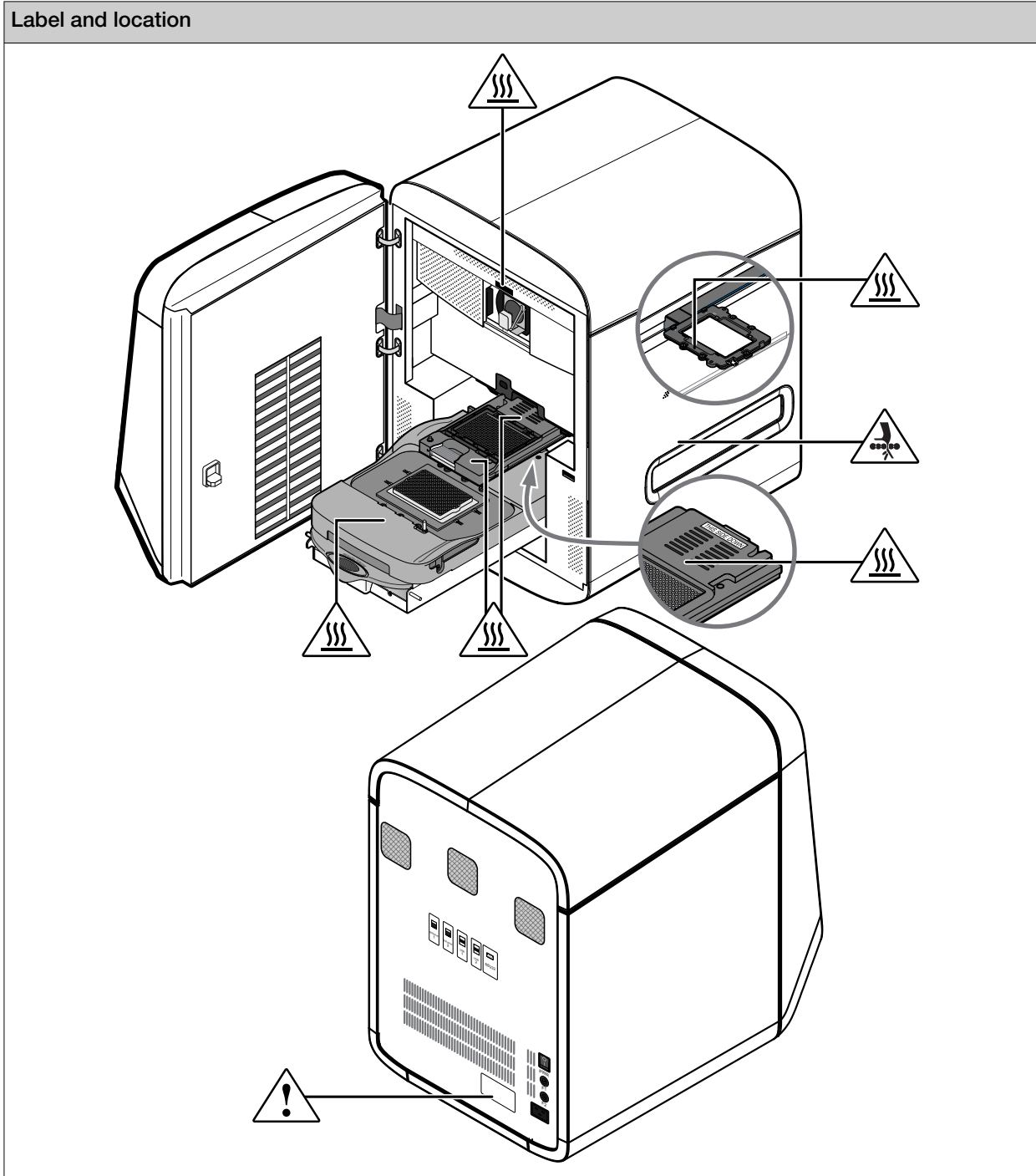



Location of safety labels











Control and connection symbols

Symbols and descriptions	
	On (Power)
	Off (Power)
	Earth (ground) terminal
	Protective conductor terminal (main ground)
	Alternating current
	Both direct and alternating current

Conformity symbols

Conformity mark	Description
	Indicates conformity with safety requirements for Canada and U.S.A.
	Indicates conformity with European Union requirements for safety and electromagnetic compatibility.
	Indicates conformity with Australian standards for electromagnetic compatibility.
	Indicates conformity with the WEEE Directive 2012/19/EU.  CAUTION! To minimize negative environmental impact from disposal of electronic waste, do not dispose of electronic waste in unsorted municipal waste. Follow local municipal waste ordinances for proper disposal provision and contact customer service for information about responsible disposal options.
	Indicates conformity with China RoHS, Environmental Friendly Use Period 25 Years.



Safety information for instruments not manufactured by Thermo Fisher Scientific

Some of the accessories provided as part of the instrument system are not designed or built by Thermo Fisher Scientific. Consult the manufacturer's documentation for the information needed for the safe use of these products.

Instrument safety

General



CAUTION! Do not remove instrument protective covers. If you remove the protective instrument panels, you may be exposed to serious hazards including, but not limited to, severe electrical shock.

Physical injury



CAUTION! Moving and Lifting Injury. The instrument is to be moved and positioned only by the personnel or vendor specified in the applicable site preparation guide. Improper lifting can cause painful and permanent back injury.

Things to consider before lifting or moving the instrument or accessories:

- Depending on the weight, moving or lifting may require two or more persons.
- If you decide to lift or move the instrument after it has been installed, do not attempt to do so without the assistance of others, the use of appropriate moving equipment, and proper lifting techniques.
- Ensure you have a secure, comfortable grip on the instrument or accessory.
- Make sure that the path from where the object is to where it is being moved is clear of obstructions.
- Do not lift an object and twist your torso at the same time. Keep your spine in a good neutral position while lifting with your legs.
- Participants should coordinate lift and move intentions with each other before lifting and carrying.
- For smaller packages, rather than lifting the object from the packing box, carefully tilt the box on its side and hold it stationary while someone else slides the contents out of the box.



CAUTION! Moving Parts. Moving parts can crush, pinch and cut. Keep hands clear of moving parts while operating the instrument. Disconnect power before servicing.



Electrical safety



WARNING! Fuse Installation. Before installing the instrument, verify that the fuses are properly installed and the fuse voltage matches the supply voltage. Replace fuses only with the type and rating specified for the unit. Improper fuses can damage the instrument wiring system and cause a fire.



WARNING! Ensure appropriate electrical supply. For safe operation of the instrument:

- Plug the system into a properly grounded receptacle with adequate current capacity.
- Ensure the electrical supply is of suitable voltage.
- Never operate the instrument with the ground disconnected. Grounding continuity is required for safe operation of the instrument.



AVERTISSEMENT ! Veiller à utiliser une alimentation électrique appropriée. Pour garantir le fonctionnement de l'instrument en toute sécurité :

- Brancher le système sur une prise électrique correctement mise à la terre et de puissance adéquate.
- S'assurer que la tension électrique est convenable.
- Ne jamais utiliser l'instrument alors que le dispositif de mise à la terre est déconnecté. La continuité de la mise à la terre est impérative pour le fonctionnement de l'instrument en toute sécurité.



WARNING! Power Supply Line Cords. Use properly configured and approved line cords for the power supply in your facility.



AVERTISSEMENT ! Cordons d'alimentation électrique. Utiliser des cordons d'alimentation adaptés et approuvés pour raccorder l'instrument au circuit électrique du site.



WARNING! Disconnecting Power. To fully disconnect power either detach or unplug the power cord, positioning the instrument such that the power cord is accessible.



AVERTISSEMENT ! Déconnecter l'alimentation. Pour déconnecter entièrement l'alimentation, détacher ou débrancher le cordon d'alimentation. Placer l'instrument de manière à ce que le cordon d'alimentation soit accessible.



Cleaning and decontamination



CAUTION! Cleaning and Decontamination. Use only the cleaning and decontamination methods that are specified in the manufacturer user documentation. It is the responsibility of the operator (or other responsible person) to ensure that the following requirements are met:

- No decontamination or cleaning agents are used that can react with parts of the equipment or with material that is contained in the equipment. Use of such agents could cause a HAZARD condition.
- The instrument is properly decontaminated a) if hazardous material is spilled onto or into the equipment, and/or b) before the instrument is serviced at your facility or is sent for repair, maintenance, trade-in, disposal, or termination of a loan. Request decontamination forms from customer service.
- Before using any cleaning or decontamination methods (except methods that are recommended by the manufacturer), confirm with the manufacturer that the proposed method will not damage the equipment.



MISE EN GARDE ! Nettoyage et décontamination. Utiliser uniquement les méthodes de nettoyage et de décontamination indiquées dans la documentation du fabricant destinée aux utilisateurs. L'opérateur (ou toute autre personne responsable) est tenu d'assurer le respect des exigences suivantes:

- Ne pas utiliser d'agents de nettoyage ou de décontamination susceptibles de réagir avec certaines parties de l'appareil ou avec les matières qu'il contient et de constituer, de ce fait, un DANGER.
- L'instrument doit être correctement décontaminé a) si des substances dangereuses sont renversées sur ou à l'intérieur de l'équipement, et/ou b) avant de le faire réviser sur site ou de l'envoyer à des fins de réparation, de maintenance, de revente, d'élimination ou à l'expiration d'une période de prêt (des informations sur les formes de décontamination peuvent être demandées auprès du Service clientèle).
- Avant d'utiliser une méthode de nettoyage ou de décontamination (autre que celles recommandées par le fabricant), les utilisateurs doivent vérifier auprès de celui-ci qu'elle ne risque pas d'endommager l'appareil.

Instrument component and accessory disposal

To minimize negative environmental impact from disposal of electronic waste, do not dispose of electronic waste in unsorted municipal waste. Follow local municipal waste ordinances for proper disposal provision and contact customer service for information about responsible disposal options.

Laser safety—barcode scanner

The optional barcode scanners included with the QuantStudio™ 6 and 7 Flex Systems are categorized as Class 2 (II) lasers.

Class 2 (II) lasers are low-power, visible-light lasers that can damage the eyes. Never look directly into the laser beam. The scanner is designed to prevent human access to harmful levels of laser light during normal operation, user maintenance, or during prescribed service operations.



The following table lists laser safety symbols and alerts that may be present on the instrument.

Alert	
	CAUTION! LASER HAZARD, Bar Code Scanner. The bar code scanner included with the instrument system is a Class 2 laser. To avoid damage to eyes, do not stare directly into the beam or point into another person's eyes.

Alerte	
	MISE EN GARDE ! RISQUE LIÉ AU RAYONNEMENT LASER, Lecteur de code-barres. Le lecteur de code-barres inclut dans l'instrument est un appareil laser de classe 2. Pour éviter toute lésion oculaire, ne regardez pas directement le faisceau et ne le dirigez pas vers les yeux d'une autre personne.

Workstation safety

Correct ergonomic configuration of your workstation can reduce or prevent effects such as fatigue, pain, and strain. Minimize or eliminate these effects by configuring your workstation to promote neutral or relaxed working positions.



CAUTION! MUSCULOSKELETAL AND REPETITIVE MOTION HAZARD. These hazards are caused by potential risk factors that include but are not limited to repetitive motion, awkward posture, forceful exertion, holding static unhealthy positions, contact pressure, and other workstation environmental factors.

To minimize musculoskeletal and repetitive motion risks:

- Use equipment that comfortably supports you in neutral working positions and allows adequate accessibility to the keyboard, monitor, and mouse.
- Position the keyboard, mouse, and monitor to promote relaxed body and head postures.

Safety and electromagnetic compatibility (EMC) standards

The instrument design and manufacture complies with the following standards and requirements for safety and electromagnetic compatibility.



Safety standards

Reference	Description
EU Directive 2014/35/EU	European Union “Low Voltage Directive”
IEC 61010-1 EN 61010-1 UL 61010-1 CAN/CSA C22.2 No. 61010-1	<i>Safety requirements for electrical equipment for measurement, control, and laboratory use – Part 1: General requirements</i>
IEC 61010-2-010 EN 61010-2-010	<i>Safety requirements for electrical equipment for measurement, control and laboratory use – Part 2-010: Particular requirements for laboratory equipment for the heating of materials</i>
IEC 61010-2-081 EN 61010-2-081	<i>Safety requirements for electrical equipment for measurement, control and laboratory use – Part 2-081: Particular requirements for automatic and semi-automatic laboratory equipment for analysis and other purposes</i>

EMC standards

Reference	Description
EU Directive 2014/30/EU	European Union “EMC Directive”
EN 61326-1 IEC 61326-1	<i>Electrical Equipment for Measurement, Control and Laboratory Use – EMC Requirements – Part 1: General Requirements</i>
FCC Part 18 (47 CFR)	U.S. Standard “Industrial, Scientific, and Medical Equipment”
AS/NZS CISPR 11	<i>Limits and Methods of Measurement of Electromagnetic Disturbance Characteristics of Industrial, Scientific, and Medical (ISM) Radiofrequency Equipment</i>
ICES-001, Issue 4	<i>Industrial, Scientific and Medical (ISM) Radio Frequency Generators</i>

Environmental design standards

Reference	Description
Directive 2012/19/EU	European Union “WEEE Directive” – Waste electrical and electronic equipment
Directive 2011/65/EU & Commission Delegated Directive (EU) 2015/863	European Union “RoHS Directive” – Restriction of hazardous substances in electrical and electronic equipment
SJ/T 11364-2014	“China RoHS” Standard – Marking for the Restricted Use of Hazardous Substances in Electronic and Electrical Products For instrument specific certificates, visit our customer resource page at www.thermofisher.com/us/en/home/technical-resources/rohs-certificates.html .



Chemical safety



WARNING! GENERAL CHEMICAL HANDLING. To minimize hazards, ensure laboratory personnel read and practice the general safety guidelines for chemical usage, storage, and waste provided below. Consult the relevant SDS for specific precautions and instructions:

- Read and understand the Safety Data Sheets (SDSs) provided by the chemical manufacturer before you store, handle, or work with any chemicals or hazardous materials. To obtain SDSs, see the "Documentation and Support" section in this document.
- Minimize contact with chemicals. Wear appropriate personal protective equipment when handling chemicals (for example, safety glasses, gloves, or protective clothing).
- Minimize the inhalation of chemicals. Do not leave chemical containers open. Use only with sufficient ventilation (for example, fume hood).
- Check regularly for chemical leaks or spills. If a leak or spill occurs, follow the manufacturer cleanup procedures as recommended in the SDS.
- Handle chemical wastes in a fume hood.
- Ensure use of primary and secondary waste containers. (A primary waste container holds the immediate waste. A secondary container contains spills or leaks from the primary container. Both containers must be compatible with the waste material and meet federal, state, and local requirements for container storage.)
- After emptying a waste container, seal it with the cap provided.
- Characterize (by analysis if needed) the waste generated by the particular applications, reagents, and substrates used in your laboratory.
- Ensure that the waste is stored, transferred, transported, and disposed of according to all local, state/provincial, and/or national regulations.
- **IMPORTANT!** Radioactive or biohazardous materials may require special handling, and disposal limitations may apply.



AVERTISSEMENT ! PRÉCAUTIONS GÉNÉRALES EN CAS DE MANIPULATION DE PRODUITS CHIMIQUES. Pour minimiser les risques, veiller à ce que le personnel du laboratoire lise attentivement et mette en œuvre les consignes de sécurité générales relatives à l'utilisation et au stockage des produits chimiques et à la gestion des déchets qui en découlent, décrites ci-dessous. Consulter également la FDS appropriée pour connaître les précautions et instructions particulières à respecter :

- Lire et comprendre les fiches de données de sécurité (FDS) fournies par le fabricant avant de stocker, de manipuler ou d'utiliser les matériaux dangereux ou les produits chimiques. Pour obtenir les FDS, se reporter à la section « Documentation et support » du présent document.
- Limiter les contacts avec les produits chimiques. Porter des équipements de protection appropriés lors de la manipulation des produits chimiques (par exemple : lunettes de sûreté, gants ou vêtements de protection).
- Limiter l'inhalation des produits chimiques. Ne pas laisser les récipients de produits chimiques ouverts. Ils ne doivent être utilisés qu'avec une ventilation adéquate (par exemple, sorbonne).
- Vérifier régulièrement l'absence de fuite ou d'écoulement des produits chimiques. En cas de fuite ou d'écoulement d'un produit, respecter les directives de nettoyage du fabricant recommandées dans la FDS.
- Manipuler les déchets chimiques dans une sorbonne.



- Veiller à utiliser des récipients à déchets primaire et secondaire. (Le récipient primaire contient les déchets immédiats, le récipient secondaire contient les fuites et les écoulements du récipient primaire. Les deux récipients doivent être compatibles avec les matériaux mis au rebut et conformes aux exigences locales, nationales et communautaires en matière de confinement des récipients.)
- Une fois le récipient à déchets vidé, il doit être refermé hermétiquement avec le couvercle fourni.
- Caractériser (par une analyse si nécessaire) les déchets générés par les applications, les réactifs et les substrats particuliers utilisés dans le laboratoire.
- Vérifier que les déchets sont convenablement stockés, transférés, transportés et éliminés en respectant toutes les réglementations locales, nationales et/ou communautaires en vigueur.
- **IMPORTANT !** Les matériaux représentant un danger biologique ou radioactif exigent parfois une manipulation spéciale, et des limitations peuvent s'appliquer à leur élimination.



WARNING! HAZARDOUS WASTE (from instruments). Waste produced by the instrument is potentially hazardous. Follow the guidelines noted in the preceding General Chemical Handling warning.



WARNING! 4L Reagent and Waste Bottle Safety. Four-liter reagent and waste bottles can crack and leak. Each 4-liter bottle should be secured in a low-density polyethylene safety container with the cover fastened and the handles locked in the upright position.

Biological hazard safety



WARNING! Potential Biohazard. Depending on the samples used on this instrument, the surface may be considered a biohazard. Use appropriate decontamination methods when working with biohazards.



WARNING! BIOHAZARD. Biological samples such as tissues, body fluids, infectious agents, and blood of humans and other animals have the potential to transmit infectious diseases. Conduct all work in properly equipped facilities with the appropriate safety equipment (for example, physical containment devices). Safety equipment can also include items for personal protection, such as gloves, coats, gowns, shoe covers, boots, respirators, face shields, safety glasses, or goggles. Individuals should be trained according to applicable regulatory and company/ institution requirements before working with potentially biohazardous materials. Follow all applicable local, state/provincial, and/or national regulations. The following references provide general guidelines when handling biological samples in laboratory environment.

- U.S. Department of Health and Human Services, *Biosafety in Microbiological and Biomedical Laboratories (BMBL)*, 6th Edition, HHS Publication No. (CDC) 300859, Revised June 2020
<https://www.cdc.gov/labs/pdf/CDC-BiosafetymicrobiologicalBiomedicalLaboratories-2020-P.pdf>
- Laboratory biosafety manual, fourth edition. Geneva: World Health Organization; 2020 (Laboratory biosafety manual, fourth edition and associated monographs)
www.who.int/publications/i/item/9789240011311



Documentation and support

Related documentation

Document	Pub. No.
<i>QuantStudio™ 6 and 7 Flex Real-Time PCR Systems Site Preparation Guide</i>	4489824
<i>QuantStudio™ Real-Time PCR Software Getting Started Guide</i>	4489822
<i>High Resolution Melt Module for QuantStudio™ 6 and 7 Flex Real-Time PCR System Software Getting Started Guide</i>	4489823
QuantStudio™ Real-Time PCR Software v1.6.1 or later	
<i>QuantStudio™ 6 and 7 Flex Real-Time PCR Systems (v1.6.1 or later) Maintenance and Administration Guide</i>	MAN0018828
<i>QuantStudio™ 6 and 7 Flex Real-Time PCR Systems (v1.6.1 or later) Quick Reference</i>	MAN0018829
QuantStudio™ Real-Time PCR Software v1.3	
<i>QuantStudio™ 6 and 7 Flex Real-Time PCR Systems Quick Reference</i>	4489826

Customer and technical support

Visit thermofisher.com/support for the latest service and support information.

- Worldwide contact telephone numbers
- Product support information
 - Product FAQs
 - Software, patches, and updates
 - Training for many applications and instruments
- Order and web support
- Product documentation
 - User guides, manuals, and protocols
 - Certificates of Analysis
 - Safety Data Sheets (SDSs; also known as MSDSs)

Note: For SDSs for reagents and chemicals from other manufacturers, contact the manufacturer.



Limited product warranty

Life Technologies Corporation and/or its affiliate(s) warrant their products as set forth in the Life Technologies' General Terms and Conditions of Sale at www.thermofisher.com/us/en/home/global/terms-and-conditions.html. If you have any questions, please contact Life Technologies at www.thermofisher.com/support.

Glossary

aligned melt curve plot

Plot of the re-scaled melt curve.

allele

In a diploid organism, one of two DNA sequences found at the same locus (for example, a particular gene), but located on homologous chromosomes. Two corresponding alleles may have the identical sequence, or they may differ somewhat, often at one or more single-base sites (SNPs).

amplicon

A segment of DNA amplified during PCR.

amplification

Part of the instrument run in which PCR amplifies the target. Fluorescence data collected during amplification are displayed in an Amplification Plot, and the data are used to calculate results.

Note: Only quantitative real-time PCR experiments, not end-point experiments, take amplification data into account.

amplification efficiency (EFF%)

Calculation of the efficiency of the PCR amplification in an experiment. EFF% is calculated using the slope of the regression line in the standard curve. A slope close to -3.32 indicates optimal, 100% PCR amplification efficiency.

Amplification Plot

Display of data collected during the cycling stage of PCR amplification. The Amplification Plot can be viewed as:

- Baseline-corrected normalized reporter (ΔR_n) vs. cycle
- Normalized reporter (R_n) vs. cycle
- Threshold cycle (C_t) vs. well

amplification stage

Part of the instrument run in which PCR amplifies the target. The amplification stage, called a cycling stage in the thermal profile, consists of denaturing, primer annealing, and extension steps that are repeated. Fluorescence data collected during the extension stage are displayed in an amplification plot, and the data are used to calculate results. With chemistry, the last two steps of a PCR stage are typically combined.

See also “cycling stage” on page 187.

assay

In a PCR reaction mix, two target-specific primers or two primers and a probe used to amplify a target.

assay mix

PCR reaction component in assays. The assay mix contains primers designed to amplify a target and a probe designed to detect amplification of the target.

automatic baseline

An analysis setting in which the software calculates the baseline start and end cycles for the amplification plot.

See also “baseline” on page 186.

automatic threshold

An analysis setting in which the software calculates the baseline start and end cycles and the threshold in the amplification plot. The software uses the baseline and threshold to calculate the threshold cycle (C_t).

See also “threshold cycle (C_t)” on page 196.

background calibration

Type of calibration in which the instrument performs reads of a background plate or array card, averages the spectra recorded during the run, and extracts the resulting spectral component to a calibration file. The software then uses the calibration file during subsequent runs to remove the background fluorescence from the run data.

baseline

From the Amplification Plot, a cycle-to-cycle range that defines background fluorescence.

baseline-corrected normalized reporter (ΔR_n)

The magnitude of normalized fluorescence signal generated by the reporter. In experiments that contain data from real-time PCR, the magnitude of normalized fluorescence signal generated by the reporter at each cycle during the PCR amplification. From the ΔR_n vs. Cycle Amplification Plot, ΔR_n is calculated at each cycle as:

$\Delta R_n(\text{cycle}) = R_n(\text{cycle}) - R_n(\text{baseline})$, where R_n = normalized reporter

See also “normalized reporter (R_n)” on page 191.

blocked IPC

In presence/absence experiments, a reaction that contains IPC blocking agent, which blocks amplification of the internal positive control (IPC). In QuantStudio™ Real-Time PCR Software, also the name of the task for the IPC target in wells that contain IPC blocking agent. See also “negative control-blocked IPC wells” on page 190.

CE mark 

The CE Mark (an acronym for the French “Conformite Europeene”) of conformity certifies that a product has met the essential requirements of the applicable European Directive.

chemistry

See “reagents” on page 192.

control

Sample of known genotype or melt-curve shape.

 C_t

See “threshold cycle (Ct)” on page 196.

 C_t algorithm

The QuantStudio™ Real-Time PCR Software uses the Baseline Threshold algorithm.

cycle threshold

See “threshold cycle (Ct)” on page 196.

cycling stage

In the thermal profile, a stage that is repeated. A cycling stage is also called an amplification stage.

See also “amplification stage” on page 185.

data collection

During the instrument run, a process in which an instrument detects fluorescence data from each well of the plate or array card. The instrument transforms the signal to electronic data and saves the data in the experiment file.

delta R_n (ΔR_n)

See “baseline-corrected normalized reporter (ΔR_n)” on page 186.

derivative melt curve plot

The default view of the melting curve. It plots the negative derivative data ($-R_n'$) vs. temperature.

Note: An alternative view is the raw data view, which plots the normalized fluorescence from reporter dye vs. temperature.

derivative reporter ($-R_n'$)

The rate of change in fluorescence as a function of temperature. R_n' is used to plot a melting curve. Significant decrease of the fluorescent signal generates a positive peak on the derivative view of the melting curve.

dissociation curve

See “melt curve” on page 189.

dye calibration

Type of calibration in which the software collects spectral data from a series of dye standards and stores the spectral information for the dye standards in a pure spectra calibration file. This file is used during experiment runs to characterize and distinguish the individual contribution of each dye in the total fluorescence collected by the instrument.

EFF%

See “amplification efficiency (EFF%)” on page 185.

error

The standard error of the slope of the regression line in the standard curve.

The error can be used to calculate a confidence interval (CI) for the slope. Because the amplification efficiency is calculated from the slope, knowing the error allows a CI for the amplification efficiency to be calculated.

experiment

Refers to the entire process of performing a run, including setup, run, and analysis.

filter

Dye excitation and emission filter combination that is set for an experiment. The QuantStudio™ 7 Flex System includes a decoupled, six by six-color filter set. The QuantStudio™ 6 Flex System includes a coupled five-color filter set. The excitation and emission filter combinations are preset by the experiment document (.eds) file for your experiment.

flag

A quality control (QC) indicator which, when applied by the software to a well during analysis, indicates a possible issue with that reaction. For example, a flag may be issued if no amplification is detected in a well. Flags indicating potential problems are displayed in the Quality Control tab of the Plate Layout, Well Table, and QC Summary screens.

forward primer

Oligonucleotide that flanks the 5' end of the amplicon. The reverse primer and the forward primer are used together in PCR reactions to amplify the target.

heterozygote

Samples having both allele 1 and allele 2.

holding stage

In the thermal profile, the stage that holds the temperature constant for a defined period of time.

homozygote

Samples having only allele 1 or only allele 2.

Instrument Console

A software feature that allows you to monitor the status of any instrument on the network; view calibration, maintenance, and instrument properties for a selected instrument; and open and close the instrument drawer.

Instrument Manager

A software feature that allows you to monitor the status of an instrument; monitor Amplification Plots and temperature plots in real time; view the calibration status, perform calibrations and manage files on the instrument, including downloading completed experiments to your computer.

internal positive control (IPC)

In presence/absence experiments, a short synthetic DNA template that is added to PCR reactions. The IPC can be used to distinguish between true negative results (the target is absent in the samples) and negative results caused by PCR inhibitors, incorrect assay setup, or reagent or instrument failure.

IPC

See “internal positive control (IPC)” on page 189.

IPC+

See “negative control-IPC wells” on page 190.

melt curve

A plot of data collected during the melt curve stage. Peaks in the melt curve can indicate the melting temperature (T_m) of the target, or they can identify nonspecific PCR amplification. In the software, you can view the melt curve as normalized reporter (R_n) vs. temperature or as derivative reporter ($-R_n'$) vs. temperature.

melt curve characteristics

The melt curve shape and the difference in melting temperature (T_m) values.

melt curve stage

In the thermal profile, a stage with a temperature increment to generate a melt curve.

melting temperature (T_m)

The temperature at which 50% of the DNA is double-stranded and 50% of the DNA is dissociated into single-stranded DNA. In a melt curve experiment, the melt curve plot displays the melting temperature.

melting transition region

In Melt Curve experiments, the region before and after the melting temperature (T_m). See also “melting temperature (T_m)” on page 189.

negative control (NC)

The task for targets or SNP assays in wells that contain water or buffer instead of sample. No amplification of the target should occur in negative control wells. Previously called no template control (NTC).

negative control-blocked IPC wells

In presence/absence experiments, wells that contain IPC blocking agent instead of sample in the PCR reaction. No amplification should occur in negative control-blocked IPC wells because the reaction contains no sample and amplification of the IPC is blocked. Previously called no amplification control (NAC).

negative control-IPC wells

In presence/absence experiments, wells that contain IPC template and buffer or water instead of sample. Only the IPC template should amplify in negative control-IPC wells because the reaction contains no sample. Previously called IPC+.

no template control (NTC)

See “negative control (NC)” on page 190.

nonfluorescent quencher-minor groove binder (NFQ-MGB)

Molecules that are attached to the 3' end of probes. When the probe is intact, the nonfluorescent quencher (NFQ) prevents the reporter dye from emitting fluorescence signal. Because the NFQ does not fluoresce, it produces lower background signals, resulting in improved precision in quantification. The minor groove binder (MGB) increases the melting temperature (T_m) of the probe without increasing its length, allowing for the design of shorter probes.

normalization calibration

Type of calibration in which the software collects data from the normalization standards, then stores it in a normalization calibration file.

normalized quantity

Either the C_t Avg. of the target gene minus the C_t Avg. of the endogenous control (Comparative C_t experiments), or the Q Avg. of the target divided by the Q Avg. of the endogenous control (Relative Standard Curve experiments).

normalized quantity mean

The relative standard curve equivalent of the ΔC_t mean value found in Comparative C_t experiments (computed as the geometric mean).

normalized quantity SE

The relative standard curve equivalent of the ΔC_t SE value found in Comparative C_t experiments (computed as the geometric standard error of the mean).

normalized reporter (R_n)

Fluorescence signal from the reporter dye normalized to the fluorescence signal of the passive reference dye (usually ROX™ dye on Thermo Fisher Scientific instruments).

outlier

A measurement (such as a C_t) that deviates significantly from the measurement of the other replicates for that same sample.

passive reference

A dye that produces fluorescence signal independent of PCR amplification, and that is added to each reaction at a constant concentration. Because the passive reference signal should be consistent across all wells, it is used to normalize the reporter dye signal to account for non-PCR related fluorescence fluctuations caused by minor well-to-well differences in volume. Normalization to the passive reference signal generally results in data with noticeably high precision among technical replicates.

plate layout

An illustration of the grid of wells and assigned content in the plate or array card. The number of rows and columns in the grid depends on the sample block that you use.

From the software, you can use the plate layout as a selection tool to assign well contents, to view well assignments, and to view results. The plate layout can be printed, included in a report, exported, and saved as a slide for a presentation.

point

One standard in a standard curve. The standard quantity for each point in a standard curve is calculated based on the starting quantity and serial factor.

positive control

In genotyping and presence/absence experiments, a DNA sample with a known genotype, homozygous or heterozygous.

In the software, the task for the SNP assay in wells that contain a sample with a known genotype.

pure dye

Fluorescent compound used to calibrate the instrument. See “system dye” on page 195.

quantity

In quantification experiments, the amount of target in the samples. Absolute quantity can refer to copy number, mass, molarity, or viral load. Relative quantity refers to the fold-difference between normalized quantity of target in the sample and normalized quantity of target in the reference sample.

quencher

A molecule attached to the 3' end of probes to prevent the reporter from emitting fluorescence signal while the probe is intact. With reagents, a nonfluorescent quencher-minor groove binder (NFQ-MGB) can be used as the quencher.

R² value

Regression coefficient calculated from the regression line in the standard curve. An important quality value, the R² value indicates the closeness of fit between the standard curve regression line and the individual C_t data points from the standard reactions. A value of 1.00 indicates a perfect fit between the regression line and the data points.

Raw Data Plot

A plot of raw fluorescent signal as detected through each emission filter, used to view raw data for individual wells and at individual cycles.

reaction mix

A solution that contains all components to run the PCR reaction, except for the template (sample, standard, or control). Also called a "PCR cocktail".

reagents

The PCR reaction components used to amplify the target and to detect amplification.

real-time PCR

Process of collecting fluorescence data during PCR. Data from the real-time PCR are used to calculate results for quantification experiments or to troubleshoot results for genotyping or presence/absence experiments.

reference sample

In relative standard curve and Comparative C_t ($\Delta\Delta C_t$) experiments, the sample used as the basis for relative quantification results. Also called the calibrator.

region of interest (ROI) calibration

Type of calibration in which the software maps the positions of the wells on the sample block of the instrument. The software uses the ROI calibration data to associate increases in fluorescence during a run with specific wells of the plate or array card. A calibration image for each individual filter must be generated to account for minor differences in the optical path.

regression coefficients

Values calculated from the regression line in standard curves, including the R² value, slope, and y-intercept. You can use the regression coefficients to evaluate the quality of results from the standards. See also "standard curve" on page 194.

regression line

In standard curve and relative standard curve experiments, the best-fit line from the standard curve. Regression line formula:

$$C_t = m [\log (Qty)] + b$$

where m is the slope, b is the y-intercept, and Qty is the standard quantity.

See also “regression coefficients” on page 192.

reject well

An action that the software performs during analysis to remove one or more wells from further analysis if a specific flag is applied to the well.

relative standard curve method

A method to determine relative quantities. This method compensates for target and endogenous control efficiency differences within each run. In all experiments, unknown samples and dilution series of template (such as cDNA) are amplified. Following a run, the instrument software interpolates relative quantities for each unknown sample from the appropriate dilution curve, then normalizes the data for each sample (or set of replicates) as follows: target QAvg. ÷ endogenous control QAvg.

replicate group

A user-defined biological grouping. A replicate group may be a set of identical reactions in an experiment.

replicates

Total number of identical reactions containing identical components and identical volumes.

reporter

A fluorescent dye used to detect amplification. With reagents, the reporter dye is attached to the 5' end.

reverse primer

An oligonucleotide that flanks the 3' end of the amplicon. The reverse primer and the forward primer are used together in PCR reactions to amplify the target.

reverse transcriptase

An enzyme that converts RNA to cDNA.

R_n

See “normalized reporter (Rn)” on page 191.

ROX™ dye

A dye supplied by Thermo Fisher Scientific, which is used as a passive reference in some experiments.

run method

Definition of the reaction volume and the thermal profile for the instrument run. The run method specifies the temperature, time, ramp, and data collection points for all steps and stages of the instrument run.

sample

The biological tissue or specimen that you are testing for a target gene.

sample definition file

A tab-delimited file (TXT) or Microsoft™ Excel™ file (XLS or XLSX) that contains the sample name and custom sample properties for a single experiment.

security, auditing and e-signature

A separately licensed software module that provides:

- **System Security** – Controls user access to the software. Provides a default Administrator user account. You can define additional user accounts and permissions.
- **Auditing** – Tracks changes made to library items, actions performed by users, and changes to the Security and Audit settings. The software automatically audits some actions silently. You can select other items for auditing and specify the audit mode. Provides reports for audited library items, Security and Audit changes, and actions.
- **Electronic Signature (e-signature)** – Controls whether users are permitted, prompted, or required to provide a user name and password when accessing certain software features. You can select which features are controlled and the number of signatures required for access. When authorized persons use this feature, they are creating a legally binding signature.

serial factor

In the software, a numeric value that defines the sequence of quantities in the standard curve. The serial factor and the starting quantity are used to calculate the standard quantity for each point in the standard curve. For example, if the standard curve is defined with a serial factor of 1:10 or 10X, the difference between any two adjacent points in the curve is 10-fold.

slope

Regression coefficient calculated from the regression line in the standard curve. The slope indicates the PCR amplification efficiency for the assay. A slope of -3.32 indicates 100% amplification efficiency.

See also “amplification efficiency (EFF%)” on page 185 and “regression line” on page 192.

stage

In the thermal profile, a group of one or more steps. Examples: PCR stage, cycling stage (also called amplification stage), and hold stage.

standard

A sample that you dilute and amplify along with unknown samples. This dilution series can contain known starting quantities of the target of interest (absolute standard curve) or it can be of known dilution factor (relative standard curve). Following the run, the software interpolates the C_t values of the unknowns to this curve, yielding either specific quantities of the target (for absolute curves) or relative quantities (for relative dilution curves).

See also “standard curve” on page 194.

standard curve

In standard curve and relative standard curve experiments:

- The best-fit line in a plot of the C_t values from the standard reactions plotted against standard quantities. See also “regression line” on page 192.
- A set of standards containing a range of known quantities. Results from the standard curve reactions are used to generate the standard curve. The standard curve is defined by the number of points in the dilution series, the number of standard replicates, the starting quantity, and the serial factor.

standard curve method

Method for determining absolute target quantity in samples. With the standard curve method, the software measures amplification of the target in samples and in a standard dilution series. Data from the standard dilution series are used to generate the standard curve. Using the standard curve, the software interpolates the absolute quantity of target in the samples.

See also “standard” on page 194 and “standard curve” on page 194.

standard dilution series

In standard curve and relative standard curve experiments, a set of standards containing a range of known quantities. The standard dilution series is prepared by serially diluting standards. For example, the standard stock is used to prepare the first dilution point, the first dilution point is used to prepare the second dilution point, and so on. In the software, the volumes needed to prepare a standard dilution series are calculated by the number of dilution points, the number of standard replicates, the starting quantity, the serial factor, and the standard concentration in the stock. See also “standard curve” on page 194.

standard quantity

In the PCR reaction, a known quantity. In standard curve experiments, the quantity of target in the standard. From the software, the units for standard quantity can be for mass, copy number, viral load, or other units for measuring the quantity of target. Standard quantity can also refer to dilution factor.

starting quantity

When defining a standard curve in the software, the highest quantity.

step

A component of the thermal profile. For each step in the thermal profile, you can set the ramp rate (ramp increment for melt curve steps), hold temperature, and hold time (duration) are set as part of the TDD file. Data collection can also be turned on or off for the ramp or the hold parts of the step in each TDD file. For cycling stages, a step is also defined by the AutoDelta status.

system dye

Dye supplied by Thermo Fisher Scientific and calibrated on the QuantStudio™ 6 and 7 Flex Systems. Before you use system dyes in your experiments, make sure the dye calibration is current in the Instrument Console.

target

The nucleic acid sequence to amplify and detect.

target color

From the software, a color assigned to a target to identify the target in the plate layout and analysis plots.

task

From the software, the type of reaction performed in the well for the target or SNP assay.

technical replicates

Wells containing identical reaction components, including sample; important for evaluating precision.

temperature plot

From the software, a display of temperatures for the instrument cover and instrument block during the instrument run.

template

The type of nucleic acid to add to the PCR reaction.

thermal profile

Part of the run method that specifies the temperature, time, ramp, and data collection points for all steps and stages of the instrument run.

experiment document file (.eds)

The Thermo Fisher Scientific name for the electronic records that comprise all information about a particular plate or array card, including metadata (name, barcode, comments), plate setup (well contents, assay definitions), run method (thermal cycling protocol), run results, analysis protocol, analysis results, audit records, and other consumable-specific data. Experiment document files have the .eds suffix.

threshold

In Amplification Plots, the level of fluorescence above the baseline and within the exponential growth region.

threshold cycle (C_t)

The PCR cycle number at which the fluorescence meets the threshold in the Amplification Plot. See also “threshold” on page 196 and “Amplification Plot” on page 185.

 T_m

See “melting temperature (T_m)” on page 189.

touchscreen

Instrument display that you touch to control the instrument.

uniformity calibration

Type of calibration in which the software measures sample block uniformity. The calibration generates data that compensate for the physical effects of the QuantStudio™ 6 and 7 Flex Systems filters on data collected during an experiment.

unknown

From the software, the task for the target in wells that contain the sample being tested. In quantification experiments, the task for the target in wells that contain a sample with unknown target quantities. In genotyping experiments, the task for the SNP assay in wells that contain a sample with an unknown genotype. In presence/absence experiments, the task for the target in wells that contain a sample in which the presence of the target is not known. In melt curve experiments, the task for the target in wells that contain a sample with an unknown melt curve profile.

variant

A sample (or group of samples) with a unique melt curve (that is, the melt curve is different from the melt curves of other samples or controls used in the experiment). The software determines melt curve differences by the melting temperature (T_m) and the shape of the melt curve.

y-intercept

From the standard curve, the value of y where the regression line crosses the y -axis. The y -intercept indicates the expected threshold cycle (C_t) for a sample with quantity equal to 1.

