

Operating Instructions

Entris

Laboratory Balances

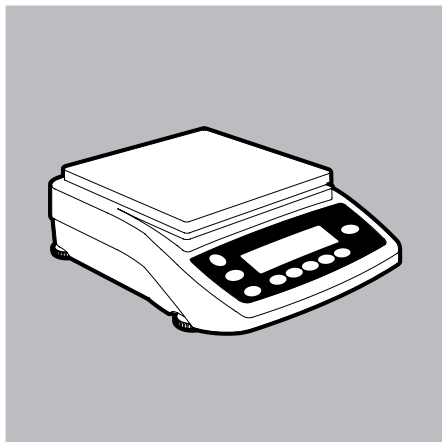
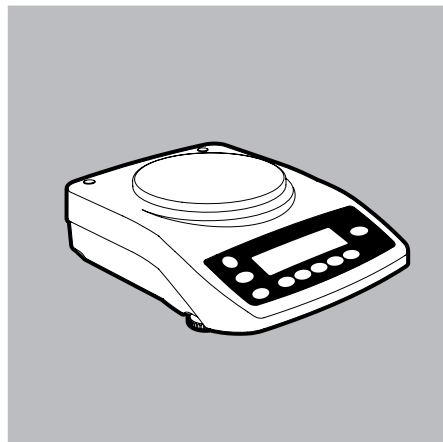
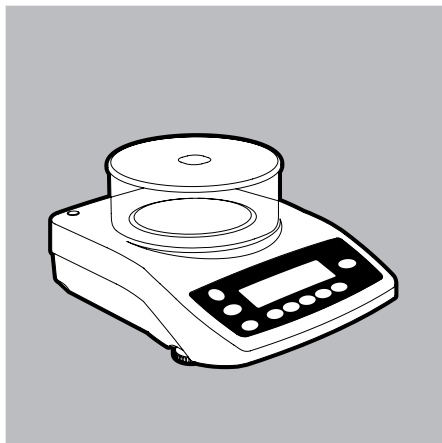
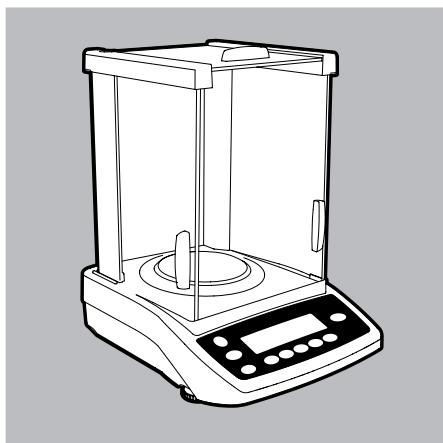

98648-019-79

User Information

Warning | danger symbols used in these instructions:



These notes identify hazards which have a high probability of resulting in death or serious physical injury if not avoided.



These notes identify hazards that can result in moderate or mild injuries if not avoided.



These notes identify hazards associated with the risk of material damage.

Explanation of Symbols

The following symbols are used in these instructions:

- ▶ Indicates a required action
- ▷ Describes what happens after you have performed a particular step

Perform steps in the specified order:

1. First action
 2. Second action
 3. ...
- Indicates an item in a list

Conventions for this User Manual:

- The illustrations in these instructions are based on “Standard” balances.

Applications Advice | Technical Support

Addresses for applications advice and technical support can be found on the website at:

<http://www.sartorius.com>

Contents

User Information	2
Explanation of Symbols	2
Applications Advice Technical Support	2
Contents	3
Intended Use	3
Safety Instructions	4
Getting Started	5
Operation	10
Display and Controls.	10
Basic Weighing Function	11
Calibration	12
Configuration (Operating Menu)	15
Functions of the Keys in the Menu	15
Menu Navigation; Example: Setting the Language	16
Menu: Structure.	17
Menu Settings: Overview	18
Application Programs	23
Counting	23
Weighing in Percent.	25
Animal Weighing Averaging	27
Toggling Between Weight Units	29
Density Determination	31
Data Interface	34
Error Codes	35
Care and Maintenance	36
Disposal	37
Overview	38
Specifications.	38
Accessories.	42
EC Declaration of Conformity	44

Intended Use

This high-precision balance is designed to be used exclusively indoors under normal atmospheric conditions.

It was developed specifically for the exact determination of the mass of materials in liquid, paste, powder, or solid form. Appropriate containers must be used for each type of sample material.

Safety Instructions

Guidelines and General Information

- The balance complies with EU Directives and standards for electrical safety and electro-magnetic compatibility*. Improper use or handling can, however, result in damage and | or injury.
Any improper use or operation of the balance, i.e., that is not consistent with the instructions, will result in forfeiture of all claims under the manufacturer's warranty.
- Personnel need to have read and understood these installation instructions, including the safety instructions.
- In the event of use in systems and ambient conditions which have greater safety requirements, you must observe the requirements and provisions applicable in your country.
- Always keep the equipment and balance freely accessible.
Any installation work or balance operation that does not conform to the instructions will result in forfeiture of all claims under the manufacturer's warranty.

* = see "Specifications"



Danger of explosion

Do not use this equipment in hazardous areas in which explosive materials are present.



Make sure that the voltage rating printed on the AC adaptor is identical to your local mains voltage.



Installation Instructions

Do not operate the device if the housing or AC adaptor is damaged. Immediately disconnect the damaged device from the power by pulling the plug.



Do not expose the balance, its power supply or accessories supplied by Sartorius to extreme temperatures, aggressive chemical vapors, moisture, shock, vibrations or strong electromagnetic fields.
Observe the conditions of operation described in the "Technical Data"!



Note on Installation:
The operator shall be solely responsible for any modifications to the equipment and for connecting any cables or equipment not supplied by Sartorius. Information on operational quality is available upon request from Sartorius. Only use original Sartorius accessories!

Note the IP protection class of the balance and its power supply!
Do not allow liquid penetration. The protection class specifies the suitability of equipment for various environmental conditions (moisture, foreign bodies).



Before cleaning the AC adapter or the balance: Unplug the power cord.

The balance may only be opened by specialized personnel trained by Sartorius.
Do not open the AC adaptor.



If glass breaks, there is a risk of injury posed by cuts on glass edges.



Lay the cables where they pose no risk of causing someone to trip.

Observe the additional safety and danger information in the following chapters.

Getting Started

Storage and Shipping Conditions

- Do not expose the balance to extreme temperatures, moisture, shocks, blows, or vibration.

Unpacking the Equipment

- ▶ After unpacking the device, check it immediately for any external damage.
- ▷ If you detect any damage, proceed as directed in the “Care and Maintenance” chapter, “Safety Inspection” section.
- ▷ Save all parts of the original packaging for any future transportation. During shipment, please do not leave cables plugged in!

Equipment Supplied

- Balance
- Weighing pan
- Pan support only for models with a round weighing pan
- Mains power supply unit

Additional equipment on the following models:

- Entris64-1S, Entris124-1S, Entris224-1S, Entris64i-1S, Entris124i-1S, Entris224i-1S
- Sliding panel draft shield
- Shield disk
- Shield plate
- Dust cover

Additional equipment on the following models:

- Entris153-1S, Entris323-1S, Entris423-1S, Entris623-1S, Entris153i-1S, Entris323i-1S, Entris423i-1S, Entris623i-1S
- Round glass draft shield (with shield plate and cover)

Setup

Choose a location that is not subject to the following negative influences:

- Heat (heater or direct sunlight)
- Drafts from open windows and doors
- Extreme vibrations during weighing
- Extreme humidity

Conditioning the Balance

Moisture in the air can condense on cold surfaces whenever the equipment is moved to a substantially warmer place. Allow the device to acclimatize for about 2 hours at room temperature, leaving it unplugged from the power supply.

Installation

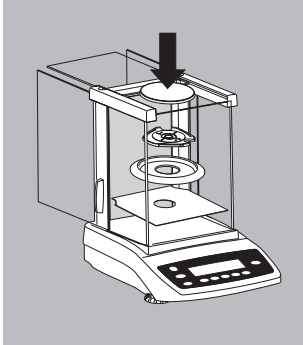

Setting up the Balance

Balances with Sliding Panel Draft Shield

- ▶ Place the components listed below inside the weighing chamber in the order given:
 - Shield plate
 - Shield disk
 - Pan support
 - Weighing pan

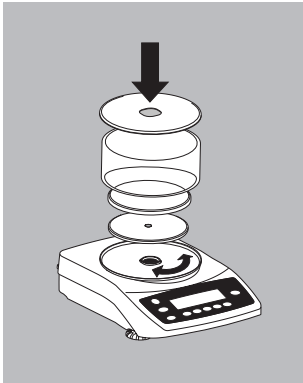

Balances with Round Glass Draft Shield

- ▶ Position the components listed below in the order given:
 - Place lid on top of the balance with the rim facing upwards and rotate until it is securely in place
 - Pan support
 - Weighing pan
 - Glass cover
 - Cover with the rim facing downwards

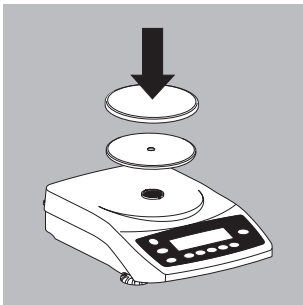

Balances with a Round Weighing Pan

- ▶ Position the components listed below in the order given:
 - Pan support
 - Weighing pan

Balances with a Rectangular Weighing Pan

- ▶ Place the weighing pan on the balance

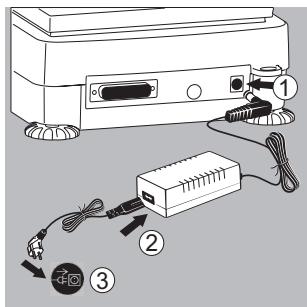

Power Connection | Safety Precautions

- Use only an original AC adapter 6971991
- ▶ Insert the right-angle plug into the jack
- ▶ Select a country-specific power cable and attach to the AC adapter
- ▶ Connect the device to the power

Mains connecting lead:

Item No.	Region Country
6971953	Europa EU (except United Kingdom)
6971954	USA Canada China Japan
6971955	United Kingdom
6971956	Australia, New Zealand
6971957	South Africa
6971964	India
6971998	Brazil
6971999	Argentina
6900931	South Korea

Safety Precautions

Desktop power supply 6971991:

An adaptor rated to Class 2 can be plugged into any wall outlet with no additional safety precautions required.

A ground or earth terminal is connected to the balance housing. The balance housing can be additionally grounded, if required for certain functions.

The data port is also galvanically linked to the balance housing (mass).

Connecting Electronic Peripheral Devices

- ▶ Make sure that the balance is unplugged from the power supply before connecting | disconnecting a peripheral device (printer or PC) to or from the interface port.

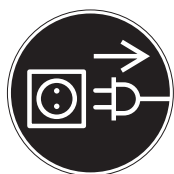

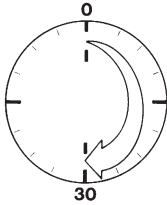

Warm-up Time

In order to provide accurate results, the instrument must warm up for 30 minutes. Only after this time will the required operating temperature have been reached.

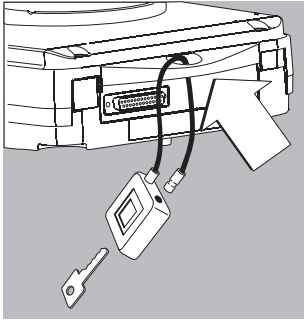

Anti-theft Locking Device

To fasten an anti-theft locking device, use the lug located on the back of the balance.

- Secure the balance at the place of location, e.g., with a chain or a lock.

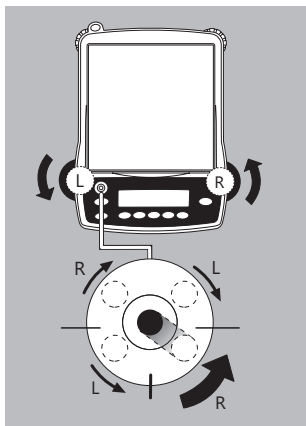

Levelling the Balance

Purpose:

- To compensate for unevenness at the place of installation

Always level the balance again any time after it has been moved to a different location. Only the 2 front feet are used for leveling.

- ▶ Screw in both rear support feet (only on models with a rectangular weighing pan).
- ▶ Turn the front levelingfeet as shown in the illustration until the air bubble is centered within the circle of the level indicator.
- > Normally, several leveling steps are required.
- ▶ On models with a rectangular weighing pan: Screw out both back leveling feet until they touch the setup surface.

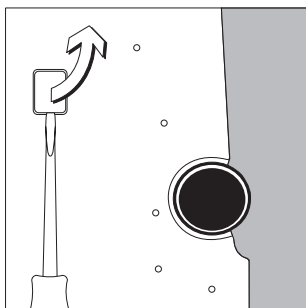

Below-Cell Weighing

A port for a below-cell weighing hook is located on the bottom of the balance.

- ▶ Not permitted for applications in legal metrology.
- ▶ Lift cover plate out of the bottom of the balance. Attention: Place the balance on its side, do not turn over completely!
- ▶ Secure hook 1: Use a wire, for example, to suspend the sample on the hook.
- ▶ Install a draft shield if necessary.

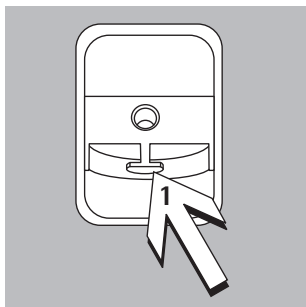

Operation

Overview of Display and Control Panel

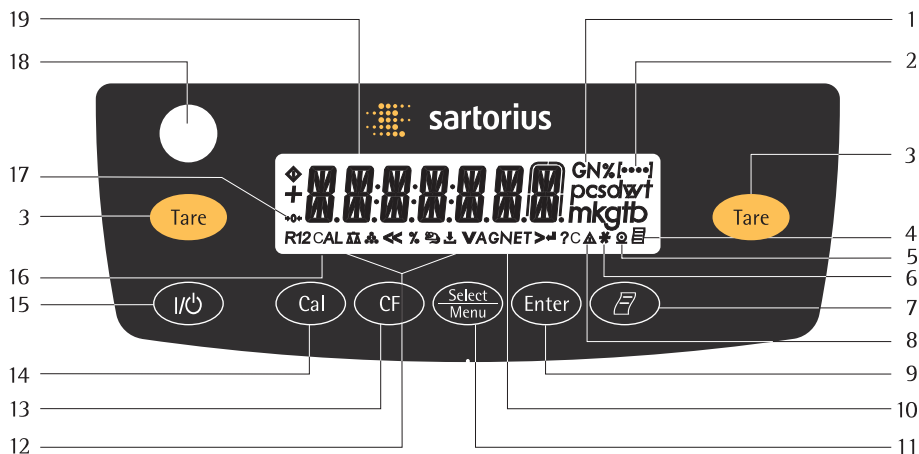

Item	Description
1	Weight units
2	Displays the menu level
3	Taring
4	Symbol for “GLP printing mode active”
5	Symbol for “Printing mode active”
6	Application program active
7	Data output: Press this key to send readout values to the built-in data interface.
8	Calculated-value indicator: not a weight value
9	Start the application program
10	Symbol: Gross or net
11	Select an application program open the operating menu
12	Symbols for active application (ΔΔ, ∙∙, %, Ⓜ, ↓, A, C)



Item	Description
13	Delete (Clear Function) This key is generally used to cancel functions: – Quit application program – Cancel calibration adjustment routine Exit menu
14	Start calibration adjustment routine
15	On Off
16	Symbol: Calibration adjustment function
17	Symbols for “zero range« (verified models only)
18	Level indicator
19	Weight value displayed in selected weight unit
Symbol:	
<<	Exit the operating menu
<	One menu level higher
∨	Scroll through menu items
>	Next item on current menu level
↓	Select a parameter setting

Basic Weighing Function

Features





- Tare the balance
 - Printing weights
- ▶ If necessary, change the configuration settings:
see the chapter entitled “Configuration”

Preparation

- ▶ Switch on the balance:
Press the  key
 - ▶ Tare the balance, if necessary:
Press the  key
- ▶ If desired, load the factory settings:
see the chapter entitled “Configuration”
- Additional Functions:
▶ Switching off the balance:
Press 

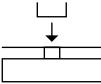
Example

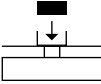
Simple Weighing

Step	Press key	Display Printout
1. Switch on the balance Self-test is performed, followed by automatic initial tare function.		0.0 g
2. Place container on weighing pan (in this example 11.5 g).		+ 11.5 g
3. Tare the balance		0.0 g
4. Place sample in container (in this example: 132 g)		+ 132.0 g
5. Print weight		N + 132.0 g

Calibration and Adjustment

Purpose

Calibration is the determination of any difference between the measured value displayed and the true weight (mass) of a sample. Adjustment is the correction of this difference, or its reduction to an allowable level within maximum permissible error limits.

Features

Calibration | adjustment can be performed only when

- there is no load on the balance
- the balance is tared
- the internal signal is stable
- the weight displayed for the sample on the balance must not differ from the nominal weight by more than 2%.

If these conditions are not met, an error message is displayed "ERR 02".

Following calibration | adjustment, the application program is cleared.

Internal Calibration | Adjustment

Note:

Only for models with the label **Entris...i-1S** !

In the operating menu, select *CAL.JUST.* - *CAL.INT.* before beginning. The built-in motorized calibration weight located in the housing is applied and removed automatically for internal calibration.

► Select calibration | adjustment:
Press 

- > The internal calibration weight is applied automatically
- > The balance is adjusted | calibrated
- > The built-in calibration weight is removed

Internal Calibration | Adjustment



Note:

Only for models with the label **Entris..i-1S** !

Set the following parameters:

SETUP - BAL.SCAL. - CAL.JUST. - CAL.INT. (Code 1.1.9.4)

The built-in motorized calibration weight located in the balance housing is applied and removed automatically for internal calibration.



Step	Key (or instruction)	Display
1. Tare the balance		0.0 g
2. Start calibration		CAL.INT.
	The internal calibration weight is applied automatically.	CAL.RUN.
3. Adjustment carried out		CAL.END
4. The internal weight is defined automatically		0.0 g

External Calibration

Set the following parameters:

SETUP - BAL.SCAL. - CAL.WGT. - CAL.EXT. (Code 1.1.9. 1)



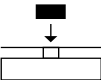
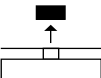



The required calibration weight is configured at the factory (see "Specifications").

Step	Key (or instruction)	Display
1. Tare balance		0.0 g
2. Start adjustment routine		CAL.EXT. - 5000.0 g
Once you store the zero point the display prompts for the required calibration weight (flashing display)		
3. Apply the prompted calibration weight (in this example 5000 g). Weight too low: a minus sign "-" is shown Weight too high: a plus sign "+" is shown		5000.0 g
The display stops flashing as soon as the weight value is within the defined limit.		
4. Calibration/adjustment executed; then the calibration weight is displayed		CAL.END + 5000.0 g
5. Remove the calibration weight		0.0 g

Configuration (Operating Menu)











You can configure the balance; i.e., adapt it to individual requirements.

Functions of the Keys during Configuration:

Symbol	Key	Function
V		Scroll through menu items
>		One menu level lower (use right cursor to scroll through up to 4 menu levels)
↵		Confirm menu item
		Save settings and exit menu from any position
<<		At the top level: Save settings and exit menu:
<		One menu level higher (left cursor)
[••••]		Indicates menu level

Menu Navigation

Example: Setting the Language

Step	Key (or instruction)	Display
1. Open the menu: Open the menu in weighing mode	 hold	APPLIC.
2. Scroll upward within the menu level; After the last menu code, the first code is displayed again	Repeatedly 	INPUT ... LANGUAG.
3. Select the next menu level (scrolls to the right)	Repeatedly 	ENGLISH °
5. Change setting: Scroll until the desired setting is shown		GERMAN
6. Confirm the menu code; "o" indicates the active setting		GERMAN °
7. Return to the next higher menu level		LANGUAG.
▷ Set other menu items as desired	 , 	
8. Save settings and exit menu or	Repeatedly: 	
▷ Exit menu without saving changes		
> Restart your application		0.0 g

Parameter Settings (Overview)







Level 1 [●]	Level 2 [●●]	Level 3 [●●●]	Menu code
SETUP	BAL.SCAL. Balance scale parameters	AMBIENT conditions	1. 1. 1.
		APPL.FILT. Application filter	1. 1. 2.
		STAB.RNG. Stability range	1. 1. 3.
		TARING Taring 1)	1. 1. 5.
		AUTZER. Auto zero	1. 1. 6.
		WT.UNIT. Basic weight unit	1. 1. 7.
		DISP.LAY. Display accuracy	1. 1. 8.
		CAL.VADJ. Function of the  key	1. 1. 9.
		CAL.UNIT. weight unit for calibration	1. 1.11.
	INTERF. Interface	BAUDrate	1. 5. 1.
		PARITY Parity	1. 5. 2.
		STOPBIT Number of stop bits	1. 5. 3.
		HANDSHK. Handshake mode	1. 5. 4.
		DATABIT Number of data bits	1. 5. 5.
		BAT.REC. Output: SBI (ASCII) or printout	1. 5. 6.
	PRNT.OUT Settings for print function	PRINT (manual automatic)	1. 6. 1.
		STOPAUT. Stop automatic printing	1. 6. 2.
		AUT.CYCL. Time-dependent autom. printing	1. 6. 3.
		TAR.VPRT. Tare bal./balance after ind. print	1. 6. 4.
		PRT.INIT. Printout of appl. parameters	1. 6. 5.
FORMAT Line format for printout		1. 6. 6.	
EXTRAS (Additional functions)	MENU Menu read only can edit	1. 8. 1.	
	SIGNAL Acoustic signal (beep)	1. 8. 2.	
	KEYS (Keypad)	1. 8. 3.	
	EXT.KEY External switch function	1. 8. 4.	
	ON.MODE Power-on mode	1. 8. 5.	
	BACKLIT Display backlighting	1. 8. 6.	
RESET	MENU Factory settings	1. 9. 1.	
APPLIC.ation programs	WEIGH		2. 1.
	UNIT Toggle wt. unit	DISP.DIG. Display accuracy	2. 2. 2.
	COUNT.ing	RESOLUT. Resolution	2. 3. 1.
	PERCENT Weighing in percent	REF.UPDT. Autom. ref. sample updating	2. 3. 2.
		DEC.PLCS Decimal places	2. 4. 1.
	ANIMAL Weighing	ACTIVITY. Animal activity	2. 7. 1.
		START	2. 7. 2.
	CALC.ulation	METHOD (Operator)	2. 8. 1.
DEC.PLCS Decimal places		2. 8. 2.	
DENSITY determination	DEC.PLCS Decimal places	2. 9. 1.	
INPUT Input	IDNO.	ID input; max. 7 characters, e.g. as Inventory no.	3. 1.
INFORMATION	VERSION, SER.NO., MODEL	Display software ver., serial no., model	4. 1. .2 .3.
LANGUAG. (LANGUAG.)	ENGLISH (factory setting)		5. 1.
	DEUTSCH (German)		5. 2.
	FRA.NC.çais (French)		5. 3.
	ITAL.iano (Italian)		5. 4.
	ESPA.NOL (Spanish)		5. 5.
	RUSSK.IY (Russian)		5. 6.
	POLSK.I (Polish)		5. 7.
	CODES Menu shows codes (not texts)		5. 8.

Parameter settings: Overview

o = Factory setting; ✓ = User-defined setting



Level 1 [●]	Level 2 [●●]	Level 3 [●●●]	Level 4 [●●●●]	Menu code
SETUP	BAL.SCAL.	AMBIENT	VERY STABLE	1. 1. 1. 1
	Balance parameters	conditions (Filter adaptation)	o STABLE	1. 1. 1. 2
			UNSTABL	1. 1. 1. 3
	VERY UNSTABLE		1. 1. 1. 4	
	APP.FILT.		o FINAL RD	1. 1. 2. 1
		Application filter	FILLING	1. 1. 2. 2
	STABILITY range		1/4 DIG. (digit)	1. 1. 3. 1
			1/2 DIG. (digit)	1. 1. 3. 2
			1 - DIGIT (digit)	1. 1. 3. 3
			o 2 - DIGIT (digit)	1. 1. 3. 4
			4 - DIGIT (digit)	1. 1. 3. 5
			8 - DIGIT (digit)	1. 1. 3. 6
	TARING	W/O STB (W/o stability)	1. 1. 5. 1	
	Taring	o W/ STB (After stability)	1. 1. 5. 2	
	AUT.ZERO	OFF	1. 1. 6. 1	
	Auto zero	o ON	1. 1. 6. 2	
	WT.UNIT	For list of units, see Chapter "Toggling between weight units"		1. 1. 7. 1
	Basic weight through unit			1. 1. 7.23
	DISP.DIG.	Display accuracy	o ALL	1. 1. 8. 1
			MINUS 1	1. 1. 8. 2
			DIVIS. 11 interval	1. 1. 8. 6
	CAL./ADJ.	Function of the of the (Cal)	CAL. EXT. External cal./adj.	1. 1. 9. 1
			o CAL. INT Internal cal./adj.	1. 1. 9. 2
			KEY BLOCKED (Cal) blocked	1. 1. 3. 3
	CAL.UNIT	Unit for calibration weight	o GRAMS	1. 1.11. 1
			KILOGR.ams	1. 1.11. 2
			POUNDS	1. 1.11. 3

Level 1 [•]	Level 2 [••]	Level 3 [•••]	Level 4 [••••]	Menu code
SETUP	INTERF. Interface	BAUDRate	600	1. 5. 1. 3
			o 1200	1. 5. 1. 4
			2400	1. 5. 1. 5
			4800	1. 5. 1. 6
			9600	1. 5. 1. 7
		19200	1. 5. 1. 8	
		PARITY Parity	o 0DD	1. 5. 2. 3
			EVEN	1. 5. 2. 4
			NONE	1. 5. 2. 5
		STOPBIT No. of stop bits	o 1STOP BIT	1. 5. 3. 1
	2BITS		1. 5. 3. 2	
	HANDSHK. Handshake mode	SFTWARE	1. 5. 4. 1	
		o HARDWARE.	1. 5. 4. 2	
		NONE	1. 5. 4. 3	
	DATABIT No. of data bits	o 7BITS	1. 5. 5. 1	
		8BITS	1. 5. 5. 2	
	DAT.REC. Com- munication mode	5BI (ASCII)	1. 5. 6. 1	
		o PRINTER	1. 5. 6. 2	
	PRNT.OUT Printing fct.	PRINT (manual automatic)	MAN.W/O stability	1. 6. 1. 1
			o MAN.WITH. stability	1. 6. 1. 2
AUT.W/O stability			1. 6. 1. 3	
AUT.WITH. stability			1. 6. 1. 4	
STOPAUT. Stop automatic printing		o OFF Not possible	1. 6. 2. 1	
		ON Use print key 	1. 6. 2. 2	
AUT.CYCL. Time-dependent autom. printing		o EACHVAL (1 display update)	1. 6. 3. 1	
		AFTER 2 (2 display updates)	1. 6. 3. 2	
TAR./PRT. Tare the balance after individual printout		o OFF	1. 6. 4. 1	
		ON	1. 6. 4. 2	

Level 1 [•]	Level 2 [••]	Level 3 [•••]	Level 4 [••••]	Menu code
SETUP	PRNT.OUT Printing fct.	PRT.INIT.	OFF	1. 6. 5. 1
		Printing application parameters	o ALL parameters	1. 6. 5. 2
			MAINPAR.ameters	1. 6. 5. 2
		FORMAT Line format for printout	16.CHAR.(digit not identified)	1. 6. 6. 1
			o 22.CHAR.acters (w/ ID)	1. 6. 6. 2
		EXTRAS (Additional functions)	MENU	CANE.DIT.Ie
	R.D.ONLY read only			1. 8. 1. 2
	SIGNAL Acoustic signal		OFF	1. 8. 2. 1
			o ON	1. 8. 2. 2
	KEYS (keypad)		o FREE	1. 8. 3. 1
			LOCKED	1. 8. 3. 2
	EXT.KEY External switch function		o PRINT Key 	1. 8. 4. 1
			Z I TARE Key 	1. 8. 4. 2
			CALL Key 	1. 8. 4. 3
			SELECT Key 	1. 8. 4. 4
			CF Key 	1. 8. 4. 5
			ENTER Key 	1. 8. 4. 6
	ON-MODE Power-on mode	o OFF /ON Off on stand-by	1. 8. 5. 1	
		STANDBY On Stand-by	1. 8. 5. 2	
		AUTO-ON Automatic on mode	1. 8. 5. 3	
BACKLIT Display backlighting	OFF	1. 8. 6. 1		
	o ON	1. 8. 6. 2		
RESET Menu reset	MENU factory settings	YES restore factory settings	1. 9. 1. 1	
		o NO Do not restore factory settings	1. 9. 1. 2	

Level 1 [•]	Level 2 [••]	Level 3 [•••]	Level 4 [••••]	Menu code
APPL. ication programs	WEIGHING toggling between weight UNITS	CONFIG. display accuracy	o ALL	2. 1.
			MINUS 1	2. 2. 2. 1
			DIV. 11 interval	2. 2. 2. 2 2. 2. 2. 6
	COUNTING	RESOLUT.	o DISP.DIG. Display accuracy	2. 3. 1. 1
			10FOLD 10 times > display	2. 3. 1. 2
	PERCENT Weighing in percent	REF.UPDT. Auto Reference- updating	o OFF	2. 3. 2. 1
			AUTOM.atic	2. 3. 2. 2
	ANIMALW. Animal weighing	DEC.PLCS. Decimal places	o NONE no decimal places	2. 4. 1. 1
			1 DEC.PL. 1 decimal place	2. 4. 1. 2
			2 DEC.PL. 2 decimal places	2. 4. 1. 3
			3 DEC.PL. 3 decimal places	2. 4. 1. 4
	ANIMALW. Animal weighing	ACTIVITY Animal activity	o CALM (fluct.: 2% of test obj.)	2. 7. 1. 1
			o ACTIVE (fluct.: 5% of test obj.)	2. 7. 1. 2
			o V.ACTIVE (fluct.: 20% of test obj.)	2. 7. 1. 3
	DENSITY determination	START	o MANUAL	2. 7. 2. 1
			o AUTOM.atic	2. 7. 2. 2
	DENSITY determination	DEC.PLCS. decimal places	o NONE no decimal places	2. 9. 1. 1
			1 DEC.PL. 1 decimal place	2. 9. 1. 2
2 DEC.PL. 2 decimal places			2. 9. 1. 3	
3 DEC.PL. 3 decimal places			2. 9. 1. 4	

Device-specific information

Level 1 [•]	Level 2 [••]	Level 3 [•••]	Example	Code
INFO rmination	VER. NO.	Show software version	REL.32.09	4. 1.
	SER. NR.	Show serial number, e.g.: (To toggle focus between upper and lower display sections: Press )	297 12345	4. 2.
	MODEL	Show model designation (to change focus from upper to middle to lower display section and back: Press )	ENTRIS 124- 15	4. 3.

Display of Menu Items: Selecting Languages or Codes

LANGUAG.	ENGLISH (factory setting)	5. 1.
(LANGUAG.)	DEUTSCH (German)	5. 2.
	FRANÇ.çais (French)	5. 3.
	ITAL.iano (Italian)	5. 4.
	ESPAÑOL (Spanish)	5. 5.
	РУССК (Russian)	5. 6.
	ПОЛСКИ (Polish)	5. 7.
	CODES Menu shows codes (not texts)	5. 8.

Application Programs

Counting

Display symbol: 

Purpose

With the Counting application, you can determine the number of parts that each have approximately equal weight. To do this, a known number of parts (the reference sample quantity) is weighed first, and the individual piece weight (reference weight) is calculated from this result. Thus the number of parts subsequently placed on the balance can be determined from their weight.

Changing the Reference Sample Quantity

Activate function:

Press the  key

Select the desired reference sample quantity (1 to 100):

In increments of 1: Press the  key briefly

In increments of 10:

Press and hold the  key.

The quantity is stored in battery-backed

memory.

Reference Sample Updating

Automatic reference sample updating optimizes the counting accuracy. You can activate or deactivate this function in the menu.

Automatic reference sample updating is performed when the requirements, including the specified stability criterion, have been met.

The abbreviation *OPT* for “optimizing”, is displayed briefly with the new reference sample quantity.

Preparation

▶ Select the Counting application in the menu:
see “Configuration”

▶ Set the following parameters:

APPLIC.ation programs

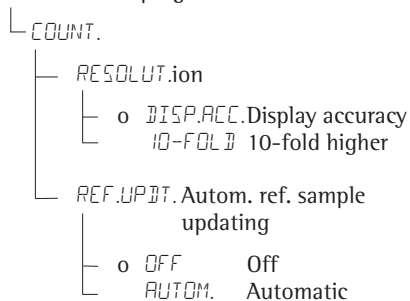

o = Factory setting

Printout: Counting

nRef	10	: Ref. sample quantity
wRef	21.14 g	: Reference weight for 1 unit
Qnt	+ 500 pcs	: Calculated quantity

Example: Counting parts of equal weight

Parameter settings: *APPLIC.* - *COUNT.* (menu code 2. 3.)

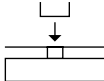
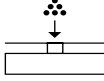
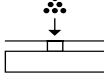
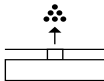
Step	Key (or instruction)	Display/Data output
1. Place empty container on the balance		+ 22.6 g
2. Tare the balance	(Tare)	0.0 g
3. Add reference sample quantity to container (in this example: 20 pcs)		
4. Changing the reference sample quantity		(Select-Menu) REF 10 pcs
5. Select reference sample quantity: In increments of 1 (1, 2, 3, ..., 100) In increments of 10 (10, 20, ..., 100)	Repeatedly: Press briefly press and hold	(Select-Menu) REF 20 pcs
6. Confirm selected reference sample quantity and start the application. The current reference weight remains saved until a new reference is set or the power supply is interrupted.	(Enter)	+ 20 pcs * nRef 20 pcs wRef 1.07 g
7. Add desired number of pieces		+ 500 pcs
8. If desired, print quantity	(Print)	Qnt + 500 pcs
9. Toggle display between mean piece weight, weight, quantity	Repeatedly: (Select-Menu)	+ 1.07 g Δ* + 535.0 g * + 500 pcs *
10. Unload the balance		- 2 pcs *
11. Repeat as needed, starting from Step 7		
12. End "Counting"	(CF)	0.0 g

Weighing in Percent

Display symbol: %

Purpose

This application allows you to obtain weight readouts in percent which are in proportion to a reference weight.

Changing the Reference Percentage

Activate function:

Press the  key

Select the desired reference (1 to 100):
In increments of 1: Press the  key briefly

Increments of 10: Press and hold the  key.

The percentage is stored in battery-backed memory.

Preparation

- ▶ Select the Weighing in percent application in the menu: see “Configuration”
- ▶ Set the following parameters:

APPLIcation programs

└ PERCENT Weighing in percent

└ DEC.PLACES Decimal places

└ NONE Decimal places

└ o 1 DEC.PL. 1 decimal place

└ 2 DEC.PL. 2 decimal places

└ 3 DEC.PL. 3 decimal places

o = Factory setting









Printout: Weighing in percent

pRef	100	: Reference percentage
Wx%	111.6 g	: Reference weight for percentage xx%
Prc	+ 94.9 %	: Calculated reference percentage

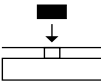
Example: Determining residual weight in percent

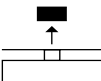
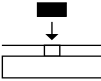
Parameter settings: *APPLIC. - PERCENT* (menu code 2. 4.)

Reference percentage: *REF 100%*

Step	Key (or instruction)	Display/Data output
1. Tare the balance		0.0 g
2. Changing the reference: (see the previous page)		<i>REF 100 %</i>
3. Place sample equal to 100% on the balance (in this example: 111.6 g)		
4. Start the application. The current reference weight remains stored until a new reference is set or power to the power supply is interrupted.		+ 100.0 % * pRef 100 % Wxx% + 111.6 g
5. Remove sample (e.g. for drying)		
6. Place weight on the balance (in this example 322.5 g)		+ 94.9 % *
7. If desired, print percentage		Prc + 94.9 %
8. Toggle display between weight and percentage	Repeatedly: 	+ 105.9 g * + 94.9 % *
9. Clear display of residual weight and reference percentage Exit application		+ 105.9 g
10. If desired, print net residual weight		N + 105.9 g

Animal Weighing/Averaging

Display symbol: 

Purpose

This application is used to determine the weights of unstable samples (e.g., live animals) or to determine weights under very unstable ambient conditions. With this program, the balance calculates the weight as the average of a defined number of individual weighing operations (also referred to as “subweighing operations”).

Changing the Number of Subweighing Operations

Activate function:

Press the  key

Select the desired number of measurements (1 to 100):

In increments of 1: Press the  key briefly

Increments of 10: Press and hold the  key.

The selected number of measurements is stored in battery-backed memory.

Preparation

- ▶ Select the Animal weighing application in the menu:
see “Configuration”
- ▶ Set the following parameters:

APPLIC.ation programs

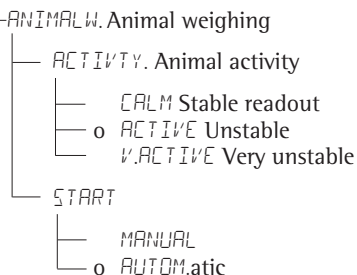

o = Factory setting

Printout: Animal weighing

mDef	20	: Number of subweighing operations
x-Net +	410.1 g	: Calculated average

Example: Determining animal weight with automatic start and 20 subweighing operations (measurements)

Parameter settings: *APPLIC. - ANIMALW.* (menu code 2. 7.)

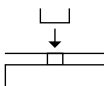
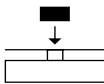
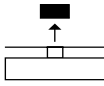
Step	Key (or instruction)	Display/Data output
1. Place animal weighing bowl on the balance		22.6 g
2. Tare the balance	(Tare)	0.0 g
3. Change the number of subweighing operations:	(Select Menu)	REF 30
4. Select number of measurements: In increments of 1 (1, 2, 3, ..., 100) In increments of 10 (10, 20, ..., 100)	Repeatedly: Press briefly press and hold	REF 20
5. Confirm number of measurements and start automatic animal weighing. The number of measurements remains stored in battery-backed memory until the setting is changed.	(Enter)	+ 0.0 g *
6. Place first animal in bowl. The balance delays the start of measurements until the difference between 2 measurements meets the criterion.		888 19 20 ... 1
7. Read off the result. The result is displayed with the "*" symbol (= calculated value) and remains displayed until the sample (animal) is removed from the load plate (bowl).		+ 410.1 g Δ* mDef 20 x-Net + 410.1 g
8. Unload the balance		+ 0.0 g *
9. Weigh next animal (if des.) Next weighing series begins automatically.		

Toggleing between Weight Units

Purpose











With this application program you can change the weight value displayed from the basic weight unit to any of 4 application weight units (see table on next page).

Features

- Set the basic unit and display accuracy in the Setup menu: see "Configuration".
- Set the application weight units and display accuracies in the Application menu.
- These settings are stored in battery-backed memory.
- The basic unit is active when the balance is powered up.

Example: Change display from the basic unit (in this example, grams [g]) to pounds [lb] and Troy ounces [ozt].

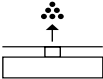
Set the following parameters: *APPLIC. - UNIT* (code 2. 2.)

Step	Press key	Display Printout
Preparation:		
1. Begin selection of an application weight unit		NONE ° [•]
2. Select an application unit, in this example "pounds" (see table on next page)	Repeatedly: 	POUNDS
3. Confirm the weight unit (pounds)		POUNDS °
4. Select the next application weight unit, in this example: Troy ounces (see table on next page)	 , Repeatedly: 	NONE ° [••] TROY.OZ.
5. Confirm weight unit (Troy ounces)		TROY.OZ. °
6. Select other application units if desired (max. 4 total) (otherwise, confirm "NO" by pressing )		[•••]
7. Store selection		0.00 g
Conversion:		
8. Place sample on balance		+ 100.00 g
9. Toggle unit for weight value	Repeatedly: 	+ 0.22046 lb + 3.5275 ozt

The following weight units are available in your balance :

Menu item	Unit	Conversion factor	Display symbol
1) USERDEF. ¹⁾	Grams	1.00000000000	o
2) GRAMS (Factory setting)	Grams	1.00000000000	g
3) KILOGR.	Kilograms	0.00100000000	kg
4) CARATS	Carats	5,00000000000	o
5) POUNDS	Pounds	0.00220462260	lb
6) OUNCES	Ounces	0.03527396200	oz
7) TROY.OZ.	Troy ounces	0.03215074700	ozt
8) HKTAEI.	Hong Kong tael	0.02671725000	tl
9) SING.TAEI.	Singapore tael	0.02645544638	tl
10) TAIW.TAEI.	Taiwanese tael	0.02666666000	tl
11) GRAINS	Grains	15.4323583500	GN
12) PENNY.WT.	Pennyweights	0.64301493100	dwt
13) MILLIGR.	Milligrams	1000.00000000	mg
14) PT.P.LB.	Parts per pound	1.12876677120	o
15) CHINA.TAEI.	Chinese tael	0.02645547175	tl
16) MOMMES	Mommes	0.26670000000	m
17) AUST.CT.	Austrian carats	5.00000000000	Kt
18) TOLA	Tola	0.08573333810	o
19) BAHT	Baht	0.06578947436	b
20) MESGHAL	Mesghal	0.21700000000	o
21) TONS	Tons	0.00000100000	t
22) LB / OZ ²⁾	Pounds : ounces	0.03527396200	lb oz
23) NEWTON	Newton	0.00980665000	N

¹⁾ = User-defined weight unit; can be loaded in the balance over an optional RS-232 or USB interface using a computer program.

²⁾ = The format for display of pounds: ounces is xx:yy.zzz; x=lb, y=oz

Density Determination

Display symbol: ρ

Purpose

This application program lets you determine the density of solid substances using the buoyancy method.

Features

To enter the density of the buoyancy liquid(g/cm³) at the corresponding temperature, press . See the next page for a table of density values for water. The factory setting is 1 g/cm³.

The following formula is applied:

Density of sample =

$$\frac{\text{Weight in air}}{\text{(Weight in air - weight in water)}} + \text{density of liquid}$$

When you start the density determination routine, the density of the liquid is displayed briefly.

Positive and negative values can be stored for weight in air and weight in water.

The weight in water must be less than the weight in air; otherwise, an error message is displayed.

The results can be displayed with 0 to 3 decimal places: see "Configuration". Not part of the scope of delivery: sample holder and suspension wire.

Preparation

- ▶ Select the Density Determination application in the menu: see "Configuration"
- ▶ Set the following parameters:

APPLIC. ation programs

DENSITY determination

DEC.PLCS Decimal places

- NONE No decimal places
- o 1 DEC.PL. 1 decimal place
- 2 DEC.PL. 2 decimal places
- 3 DEC.PL. 3 decimal places

o = Factory setting

Note on using 3 decimal places:
Using three decimal places for density can result in a high measurement error rate because corrections to the air density and the density calculation sets are not taken into account, for example.

Printout for Density Determination

RhoFl	0.99823	o	: Density of liquid (g/cm ³)
Wa	+	20.0	g : Weight in air
Wfl	+	15.0	g : Weight in liquid
Rho		4.0	o : Result: density of the sample







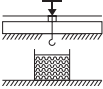

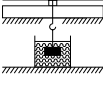



Table:
Density of H₂O at Temperature T (in °C)

T/°C	0.0	0.1	0.2	0.3	0.4	0.5	0.6	0.7	0.8	0.9
10.	0.99973	0.99972	0.99971	0.99970	0.99969	0.99968	0.99967	0.99966	0.99965	0.99964
11.	0.99963	0.99962	0.99961	0.99960	0.99959	0.99958	0.99957	0.99956	0.99955	0.99954
12.	0.99953	0.99951	0.99950	0.99949	0.99948	0.99947	0.99946	0.99944	0.99943	0.99942
13.	0.99941	0.99939	0.99938	0.99937	0.99935	0.99934	0.99933	0.99931	0.99930	0.99929
14.	0.99927	0.99926	0.99924	0.99923	0.99922	0.99920	0.99919	0.99917	0.99916	0.99914
15.	0.99913	0.99911	0.99910	0.99908	0.99907	0.99905	0.99904	0.99902	0.99900	0.99899
16.	0.99897	0.99896	0.99894	0.99892	0.99891	0.99889	0.99887	0.99885	0.99884	0.99882
17.	0.99880	0.99879	0.99877	0.99875	0.99873	0.99871	0.99870	0.99868	0.99866	0.99864
18.	0.99862	0.99860	0.99859	0.99857	0.99855	0.99853	0.99851	0.99849	0.99847	0.99845
19.	0.99843	0.99841	0.99839	0.99837	0.99835	0.99833	0.99831	0.99829	0.99827	0.99825
20.	0.99823	0.99821	0.99819	0.99817	0.99815	0.99813	0.99811	0.99808	0.99806	0.99804
21.	0.99802	0.99800	0.99798	0.99795	0.99793	0.99791	0.99789	0.99786	0.99784	0.99782
22.	0.99780	0.99777	0.99775	0.99773	0.99771	0.99768	0.99766	0.99764	0.99761	0.99759
23.	0.99756	0.99754	0.99752	0.99749	0.99747	0.99744	0.99742	0.99740	0.99737	0.99735
24.	0.99732	0.99730	0.99727	0.99725	0.99722	0.99720	0.99717	0.99715	0.99712	0.99710
25.	0.99707	0.99704	0.99702	0.99699	0.99697	0.99694	0.99691	0.99689	0.99686	0.99684
26.	0.99681	0.99678	0.99676	0.99673	0.99670	0.99668	0.99665	0.99662	0.99659	0.99657
27.	0.99654	0.99651	0.99648	0.99646	0.99643	0.99640	0.99637	0.99634	0.99632	0.99629
28.	0.99626	0.99623	0.99620	0.99617	0.99614	0.99612	0.99609	0.99606	0.99603	0.99600
29.	0.99597	0.99594	0.99591	0.99588	0.99585	0.99582	0.99579	0.99576	0.99573	0.99570
30.	0.99567	0.99564	0.99561	0.99558	0.99555	0.99552	0.99549	0.99546	0.99543	0.99540

Parameter settings:

APPLIC. - DENSITY - DEC.PLCS. - 1 DEC.PL. (menu code 2. 9. 1. 2)

Example: Determining the density of a solid using water as the buoyancy liquid.
The density of water at 20°C is 0.99823 g/cm³.

Step	Key (or instruction)	Display/Data output
1. Attach sample holder and suspension wire		
2. Tare the balance		0.0 g
3. Edit the stored density value		- 1.00000
4. Enter the density of the liquid (in this example: 0.99823); Enter numerals in increments of 1	Repeatedly:  , briefly or press and hold ;  , etc.	- 0.99823
5. Save density value and start application. The density value is stored in battery-backed memory until the setting is changed.		
6. Confirm "AIR" display		AIR ?
7. Determine the weight of sample in the air: Place sample on the balance		+ 20.0 g ?*
8. Store value for weight in air		
9. Remove sample from the balance		WATER ?
10. Determine weight in liquid: Place sample in holder.		
11. Confirm "WATER" display		0.0 g ?*
12. Immerse sample in liquid		+ 15.0 g ?*
13. Store value for weight in liquid, view and print result		+ 4.0 ^o ?*
		RhoFL 0.6237 o
		Wa + 20.0 g
		WfL + 15.0 g
14. Delete result		Rho 4.0 o
15. Repeat as needed, starting from Step 5.		

Data Interface

Purpose

Your balance comes equipped with an interface port for connection to a computer or other peripheral device. You can use an on-line computer to change, start and/or monitor the functions of the balance and the application programs.

Female interface connector

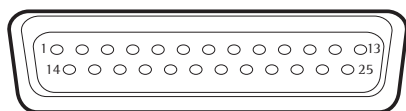

Pin Assignment Chart, 25-pin, RS-232:

- Pin 1: Shield
- Pin 2: Data output (TxD)
- Pin 3: Data input (Rx/D)
- Pin 4: Internal ground (GND)
- Pin 5: Clear to Send (CTS)
- Pin 6: Not connected
- Pin 7: Internal ground (GND)
- Pin 8: Internal ground (GND)
- Pin 9: Not connected
- Pin 10: Not assigned
- Pin 11: + 12 V (operating voltage for Sartorius printer)
- Pin 12: Reset _ Out
- Pin 13: + 5 V
- Pin 14: Internal ground (GND)
- Pin 15: Universal remote switch
- Pin 16: Not connected
- Pin 17: Not connected
- Pin 18: Not connected
- Pin 19: Not connected
- Pin 20: Data Terminal Ready (DTR)
- Pin 21: Not connected
- Pin 22: Not connected
- Pin 23: Not connected
- Pin 24: Not connected
- Pin 25: + 5 V

Preparation

You can set these parameters for other devices in the Setup menu: see "Configuration".

You will also find a detailed description

of the available data interface commands in the file "Data Interface Descriptions for Entris Models", which you can download from the Sartorius website:

(www.sartorius.com
"Download Center".)



*) = Hardware restart

Troubleshooting Guide

Error codes are shown on the main display for approx. 2 seconds.
The program then returns automatically to the previous mode.

Display	Cause	Solution
No segments appear on the display	No AC power is available The power supply is not plugged in	Check the AC power supply Plug in the power supply
HIGH	The load exceeds the balance capacity	Unload the balance
LOW or ERR 54	Something is touching the weighing pan	Move the object that is touching the weighing pan
APP.ERR.	Cannot store data: Load on weighing pan too light or no sample on pan while application is active	Increase load
BIS.ERR.	Display error: Data output not compatible with output format	Change the configuration in the operating menu
PRT.ERR.	Interface port for printer output is blocked	Reset the menu factory settings or Contact your local Sartorius Service Center
ERR 02	Calibration parameter not met, e.g.: – Press Tare to tare the balance – load on weighing pan	Calibrate only when zero is displayed Unload the balance
ERR 10	The Tare key is blocked for active application programs; Only 1 tare function can be used at a time	After the tare memory has been deleted using the CF key, the Tare key can be used again
ERR 11	Tara memory not allowed	Press Tare
The weight readout changes constantly	Unstable ambient conditions (excessive vibration or draft) A foreign object is caught between weighing pan and housing	Set up balance in another area Adjust Setup configuration Remove the foreign object
The weight readout is obviously wrong	The balance was not calibrated/adjusted Balance not tared before weighing	Calibrated/adjust the balance

If any other errors occur, contact your local Sartorius Service Center.

Web address: <http://www.sartorius.com>

Care and Maintenance

Service

On request, Sartorius can offer you an individual service contract.

Repairs

Repair work must only be carried out by trained service technicians. Repairs performed by untrained persons may result in considerable hazards for the user.

Cleaning



Unplug the AC adapter from the wall outlet (mains supply). If you have an interface cable connected to the balance port, unplug it from the port. Make sure that no liquid enters the balance housing.

- ▶ Clean the balance with a cloth lightly moistened with soap solution.
- ▷ The plastic top and bottom parts of the balance housing have a special coating that allows acetone to be used to clean these parts.



Do not clean the following parts with acetone or aggressive cleaning agents: foil-covered keypad, power connector port, data interface, or any other plastic parts.

- ▶ Wipe the balance with a soft, dry cloth.

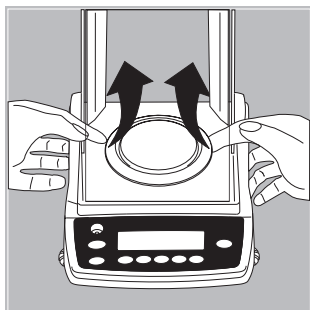

On analytical balances remove and clean the weighing pan as follows:



Reach beneath the shield disk and lift it up carefully together with the weighing pan to avoid damaging the weighing system. Make sure that no liquid enters the balance housing.

Cleaning Stainless Steel Surfaces

Clean all stainless steel parts regularly. Remove the stainless steel weighing pan and thoroughly clean it separately. Use a damp cloth or sponge to clean stainless steel parts on the balance.

You can use any household cleaning agent that is suitable for use on stainless steel. Clean stainless steel surfaces only by wiping them down. Then rinse the equipment thoroughly, making sure to remove all residues. Afterwards, allow the equipment to dry. If desired, you can apply oil to the cleaned surfaces as additional protection.

Recycling

Safety Inspections

If there is any indication that safe operation of the balance is no longer warranted:

- ▶ Disconnect the equipment from the AC power: Unplug the power cord.
- > Lock the balance in a secure place to ensure that it cannot be used for the time being

Inform Sartorius Service Center. Maintenance and repair work may only be carried out by trained service technicians.

We recommend that the device be inspected by a certified electrician at regular intervals, according to the following checklist:

- Insulating resistance > 7 megaohms measured with a constant voltage of at least 500 V at a 500 kohm load
- Leakage current: < 0.05 mA measured with a properly calibrated multimeter

Recycling

The packaging is made of environmentally friendly materials that can be used as secondary raw materials. If you no longer need this packaging, bring it to your local recycling and waste disposal facility according to the regulations applicable in your country .

(Contract number D-59101-2009-1129).

Otherwise you should dispose of the material in accordance with the waste disposal regulations that are applicable in your area.



The equipment, including accessories and batteries, does not belong in your regular household waste. The EU legislation requires its Member States to collect electrical and

electronic equipment and disposed of it separately from other unsorted municipal waste with the aim of recycling it.

For more information regarding disposal and recycling, please contact our local service representatives. Our partners listed on the following website will also be able to provide assistance within the EU:

- 1) Go to <http://www.sartorius.com>.
- 2) Select the "Services" tab.
- 3) Then select "Disposal Information".
- 4) Addresses for the local Sartorius disposal contacts can be found in the PDF files available for download on this page.



Sartorius will not take back equipment contaminated with hazardous materials (ABC contamination) – either for repair or disposal.

Service address disposal:

Please refer to our website (www.sartorius.com) or contact the Sartorius Service Center for more detailed information regarding repair service addresses or the disposal of your device.

Overview

Specifications

General Specifications

Int. weight circuit	All models with the designation Entris ... i-1S are equipped with an internal calibration weight.	
Mains connection, voltage, frequency	via Desktop power supply 697 199, 100 – 240 Vac, ±10%, 50–60 Hz; 200 mA (max.)	
Power consumption	VA	maximum 16; average 8 (including power supply)
Operating time with external battery YRB11Z (display backlighting on), approx. h		35

Ambient conditions

The Technical Data are valid for the following ambient conditions:

Operating temperature range	+10 ... +30 °C (+50 °F ... +86 °F)
Permissible ambient operating temperature	+5 ... +40 °C

Functionality is guaranteed up to an ambient temperature +5 °C to 40 °C.

Electromagnetic Compatibility (EMC)	EN61326-1
Interference emission	Class B
Defined immunity to interference for industrial environments	

Model-specific Specifications

Model: Entris		224-1S	124-1S	64-1S
		224i-1S	124i-1S	64i-1S
Weighing capacity		220 g	120 g	60 g
Readability		0.0001 g	0.0001 g	0.0001 g
Tare range (subtractive)		220 g	120 g	60 g
Repeatability (standard deviation)	< ±	0.0001 g	0.0001 g	0.0001 g
Linearity	<±	0.0002 g	0.0002 g	0.0002 g
Response time (average)	s	2,5	2,5	2,5
Sensitivity drift within +10 ... +30 °C	<±/K	2 · 10 ⁻⁶	2 · 10 ⁻⁶	2 · 10 ⁻⁶
Adaptation to ambient conditions		By selection of 1 of 4 optimized filter levels; display update: 0.1–0.4 (depends on filter level selected)		
External calibration weight (of at least accuracy class...)	g	200 (E2)	100 (E2)	50 (E2)
Net weight, approx.	kg	4.4 4.8	4.4 4.8	4.4 4.8
Weighing pan size	mm	90 Ø	90 Ø	90 Ø
Whg. chamber height	mm	230	230	230
Dimensions (W × D × H)	mm	230 × 303 × 330		

Model: Entris		623-1S	423-1S	323-1S
		623i-1S	423i-1S	323i-1S
Weighing capacity		620 g	420 g	320 g
Readability		0.001 g	0.001 g	0.001 g
Tare range (subtractive)		620 g	420 g	320 g
Repeatability (standard deviation)	< ±	0.001 g	0.001 g	0.001 g
Linearity	<±	0.002 g	0.002 g	0.002 g
Response time (average)	s	1	1	1.1
Sensitivity drift within +10 ... +30 °C	<±/K	2 · 10 ⁻⁶	2 · 10 ⁻⁶	2 · 10 ⁻⁶
Adaptation to ambient conditions		By selection of 1 of 4 optimized filter levels; display update: 0.1 – 0.4 (depending on the set filter level)		
External calibration weight (of at least accuracy class...)	g	500 (F1)	200 (F1)	200 (F1)
Net weight, approx.	kg	3.2 3.6	3.2 3.6	3.2 3.6
Weighing pan size	mm	115 Ø	115 Ø	115 Ø
Dimensions (W × D × H)	mm	230 × 303 × 136		

Modele: Entris		153-1S 153i-1S	822-1S 822i-1S
Weighing capacity		150 g	820 g
Readability		0.01 g	0.001 g
Tare range (subtractive)		150 g	320 g
Repeatability (standard deviation)	< ±	0.01 g	0.001 g
Linearity	<±	0.03 g	0.002 g
Response time (average)	s	1.3	1.3
Sensitivity drift within +10 ... +30 °C	<±/K	4 · 10 ⁻⁶	5 · 10 ⁻⁶
Adaptation to ambient conditions		By selection of 1 of 4 optimized filter levels; display update: 0.1–0.4 (depends on filter level selected)	
External calibration weight (of at least accuracy class...)	g	100 (F1)	500 (F2)
Net weight, approx.	kg	2.6 3.0	2.0 2.6
Weighing pan size	mm	150 Ø	150 Ø
Deviations (W×D×H)	mm	230×303×91	230×303×87

Modele: Entris		6202-1S 6202i-1S	4202-1S 4202i-1S	3202-1S 3202i-1S	2202-1S 2202i-1S
Weighing capacity		6200 g	4200 g	3200 g	2200 g
Readability		0.01 g	0.01 g	0.01 g	0.01 g
Tare range (subtractive)		6200 g	4200 g	3200 g	2200 g
Repeatability (standard deviation)	< ±	0.01 g	0.01 g	0.01 g	0.01 g
Linearity	<±	0.03 g	0.03 g	0.03 g	0.03 g
Response time (average)	s	1.5	1.5	1.5	1.5
Sensitivity drift within +10 ... +30 °C	<±/K	2 · 10 ⁻⁶	2 · 10 ⁻⁶	2 · 10 ⁻⁶	2 · 10 ⁻⁶
Adaptation to ambient conditions		By selection of 1 of 4 optimized filter levels; display update: 0.1–0.4 (depends on filter level selected)			
External calibration weight (of at least accuracy class...)	g	5000 (F1)	2000 (F1)	2000 (F1)	2000 (F1)
Net weight, approx.	kg	3.1 3.5	3.1 3.5	3.1 3.5	3.1 3.5
Weighing pan size	mm	180×180	180×180	180×180	180×180
Dimensions (W×D×H)	mm	230×303×91			

Model: Entris		8201-1S 8201i-1S	5201-1S 5201i-1S	2201-1S 2201i-1S
Weighing capacity		8200 g	5200 g	2200 g
Readability		0.1 g	0.1 g	0.1 g
Tare range (subtractive)		8200 g	5200 g	2200 g
Repeatability (standard deviation)	< ±	0.1 g	0.1 g	0.1 g
Linearity	<±	0.1 g	0.1 g	0.1 g
Response time (average)	s	1.5	1.5	1.5
Sensitivity drift within +10 ... +30 °C	<±/K	10 · 10 ⁻⁶	10 · 10 ⁻⁶	10 · 10 ⁻⁶
Adaptation to ambient conditions		By selection of 1 of 4 optimized filter levels; display update: 0.1–0.4 (depends on filter level selected)		
External calibration weight (of at least accuracy class...)	g	5000 (F2)	5000 (F2)	2000 (F2)
Net weight, approx.	kg	2,7 3,5	2,7 3,5	2,7 3,5
Weighing pan size	mm	180 × 180	180 × 180	180 × 180
Dimensions (W × D × H)	mm	230 × 303 × 91		

Accessories

External calibration weights:

For Entris balance models	Accuracy class	Weight in grams	Order no.:
224	E2	200	YCW522-AC-02
124	E2	100	YCW512-AC-02
64	E2	50	YCW512-AC-02
423	F1	200	YCW523-AC-02
323	F1	200	YCW523-AC-02
153	F1	100	YCW513-AC-02
623	F1	500	YCW553-AC-02
4202	F1	2000	YCW623-AC-02
6202	F1	5000	YCW653-AC-02
3202	F1	2000	YCW623-AC-02
2202	F1	2000	YCW623-AC-02
822	F2	500	YCW554-AC-02
8201	F2	5000	YCW654-AC-02
5201	F2	5000	YCW654-AC-02
2201	F2	2000	YCW624-AC-02

Product	Order No.	Product	Order No.
Data printer with date, time, statistics evaluation, transaction counter functions and LCD display	YDP20-OCE	Density determination kit – for Entris 224 – for Entris 124 – for Entris 64	YDK01LP
Remote display, reflective (for connection to data interface port)	YRD03Z	Data cable – for connection to a PC mit USB port – for PC connection, 25-pin – for PC connection, 9-pin	YCC01-USBM2 7357312 7357314
External rechargeable battery pack With battery-level indicator (LED); can be recharged using the AC adapter (charge time for completely discharged battery pack: 15 hours); see “Specifications” for hours of operation. To recharge the battery pack: Unplug the AC adapter from the balance and plug it into the battery pack	YRB11Z	Adapter cable from D-Sub 25-pin male connector to D-Sub 9-contact female connector; length: 0.25 m	6965619

Product	Order No.
Ionizing blower for eliminating static electricity	
- 220 V	YIB01-ODR
- 110 V	YIB01-OUR
Stat-Pen antistatic device for eliminating electrostatic charges on samples and containers (100 V bis 230 V, 50/60 Hz)	YSTP01
Weighing Table	
- made from wood with synthetic stone	YWT09
- weighing table made from synthetic stone, with vibration dampening	YWT03
Wall console	YWT04
Weighing pans	
- 1000 ml, EG 240 g, stainless steel	641211
- 500 ml	641212
- 110 ml, 90 mm Ø, aluminum	69GP0003
- 270 ml, EG 62 g, 137 mm Ø, stainless steel	YWP03G
- 62 mm Ø, stainless steel	6910848
- 85 ml, 70 mm Ø, aluminum	YWP06G
- 180 ml, 90 mm Ø, aluminum	YWP05G
- 174 mm d, stainless steel	YWP04G



CE EG-/EU-Konformitätserklärung
EC / EU Declaration of Conformity

Hersteller **Sartorius Lab Instruments GmbH & Co. KG**
Manufacturer **Weender Landstrasse 94 – 108, D-37075 Goettingen, Germany**

erklärt in alleiniger Verantwortung, dass das Betriebsmittel
declares under own responsibility that the equipment

Geräteart **Elektronische Laborwaage**
Device type **Electronically laboratory balance**

Baureihe **Entris.....-15**
Type series

in der von uns in Verkehr gebrachten Ausführung mit den grundlegenden Anforderungen der folgenden Europäischen Richtlinien übereinstimmt und die anwendbaren Anforderungen folgender harmonisierter Europäischer Normen erfüllt:
in the form as delivered complies with the essential requirements of the following European Directives and meets the applicable requirements of the harmonized European Standards listed below:

2004/108/EG
2004/108/EC
Elektromagnetische Verträglichkeit
Electromagnetic compatibility
EN 61326-1:2006
Elektrische Mess-, Steuer-, Regel- und Laborgeräte – EMV- Anforderungen – Teil 1: Allgemeine Anforderungen
Electrical equipment for measurement, control and laboratory use – EMC requirements – Part 1: General requirements

2006/95/EG
2006/95/EC
Elektrische Betriebsmittel zur Verwendung innerhalb bestimmter Spannungsgrenzen
Electrical equipment designed for use within certain voltage limits
EN 61010-1:2010
Sicherheitsbestimmungen für elektrische Mess-, Steuer-, Regel- und Laborgeräte – Teil 1: Allgemeine Anforderungen
Safety requirements for electrical equipment for measurement, control, and laboratory use – Part 1: General requirements

2011/65/EU
2011/65/EU
Beschränkung der Verwendung bestimmter gefährlicher Stoffe in Elektro- und Elektronikgeräten (RoHS)
Restriction of the use of certain hazardous substances in electrical and electronic equipment (RoHS)
EN 50581:2012
Technische Dokumentation zur Beurteilung von Elektro- und Elektronikgeräten hinsichtlich der Beschränkung gefährlicher Stoffe
Technical documentation for the assessment of electrical and electronic products with respect to the restriction of hazardous substances
Jahreszahl der CE-Kennzeichenvergabe | *Year of the CE mark assignment:* 13

Sartorius Lab Instruments GmbH & Co. KG
Goettingen, 2013-12-12

Dr. Reinhard Baumfalk
Vice President R&D

Dr. Dieter Klausgrete
Head of International Certification Management

Diese Erklärung bescheinigt die Übereinstimmung mit den genannten EG- und EU-Richtlinien, ist jedoch keine Zusicherung von Eigenschaften. Bei einer mit uns nicht abgestimmten Änderung des Produktes verliert diese Erklärung ihre Gültigkeit. Die Sicherheitshinweise der zugehörigen Produktdokumentation sind zu beachten.

This declaration certifies conformity with the above mentioned EC and EU Directives, but does not guarantee product attributes. Unauthorised product modifications make this declaration invalid. The safety information in the associated product documentation must be observed.

SLI13CE003-00.de.cn

2011609

GOP-1.113-fo2

Buy Sartorius Balances at www.balances.com

Visit www.scaleman.com to buy Sartorius Balances

Sartorius Lab Instruments GmbH & Co. KG
Weender Landstrasse 94–108
37075 Goettingen, Germany
Telephone 0551.308.0
Fax 0551.308-3289

www.sartorius.com

Copyright by Sartorius, Goettingen,
Germany.

No part of this publication may be reprinted
or translated in any form or by any means
without prior written from Sartorius.

All rights reserved by Sartorius AG in
accordance with copyright law.

The information and figures contained in
these instructions correspond to the version
date specified below. Sartorius reserves the
right to make changes to the technology,
features, specifications, and design of the
equipment without notice.

Date:
December 2013,
Sartorius Lab Instruments GmbH & Co. KG